

Analyses and Historical Reconstruction of Groundwater Flow, Contaminant Fate and Transport, and Distribution of Drinking Water Within the Service Areas of the Hadnot Point and Holcomb Boulevard Water Treatment Plants and Vicinities, U.S. Marine Corps Base Camp Lejeune, North Carolina

Chapter A—Supplement 8

Field Tests, Data Analyses, and Simulation of the Distribution of Drinking Water with Emphasis on Intermittent Transfers of Drinking Water Between the Hadnot Point and Holcomb Boulevard Water-Distribution Systems



Hadnot Point water treatment plant (Building 20)



HP-652 well house

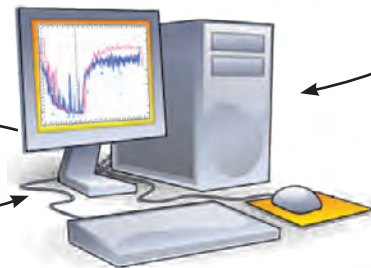
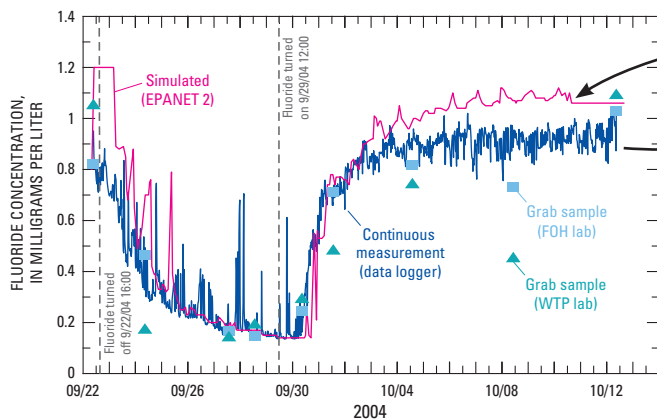
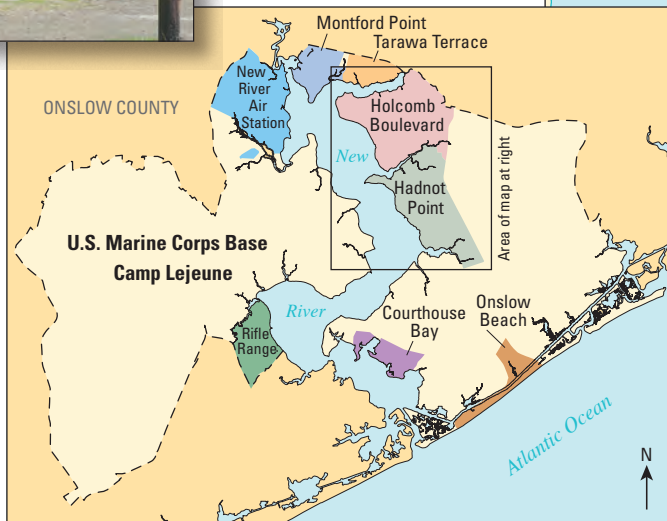
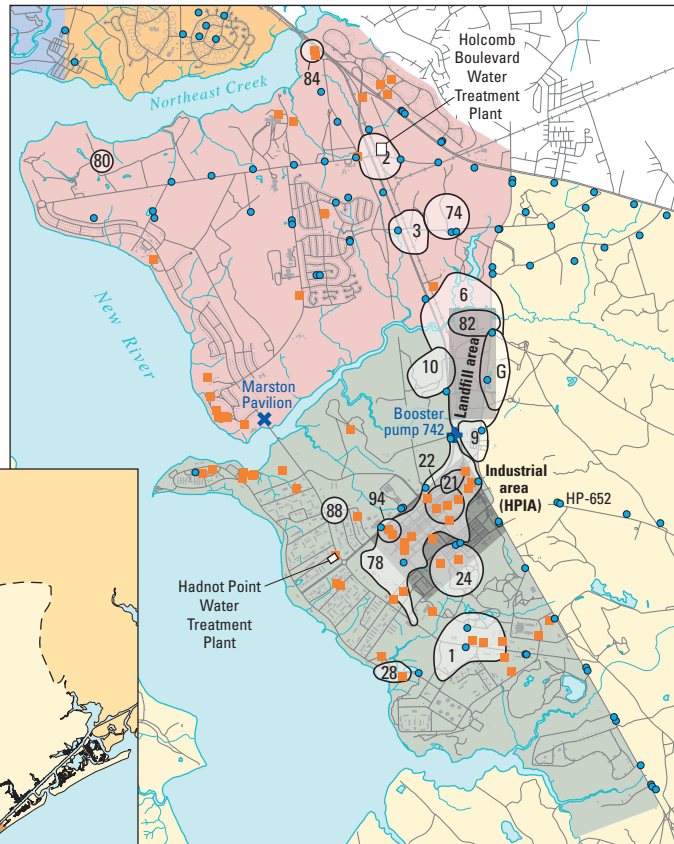

Atlanta, Georgia—March 2013

Front cover: Historical reconstruction process using data, information sources, and water-modeling techniques to estimate historical contaminant concentrations.

Maps: U.S. Marine Corps Base Camp Lejeune, North Carolina; Holcomb Boulevard and Hadnot Point areas showing extent of sampling at Installation Restoration Program sites (white numbered areas), above-ground and underground storage tank sites (orange squares), and water-supply wells (blue circles).

Photograph (upper): Hadnot Point water treatment plant (Building 20).

Photograph (lower): Well house building for water-supply well HP-652.

Graph: Measured fluoride data and simulation results for Paradise Point elevated storage tank (S-2323) for tracer test of the Holcomb Boulevard water-distribution system, September 22–October 12, 2004; simulation results obtained using EPANET 2 water-distribution system model assuming last-in first-out plug flow (LIFO) storage tank mixing model. [WTP lab, water treatment plant water-quality laboratory; FOH lab, Federal Occupational Health Laboratory]

**Analyses and Historical Reconstruction of Groundwater Flow,
Contaminant Fate and Transport, and Distribution of Drinking Water
Within the Service Areas of the Hadnot Point and
Holcomb Boulevard Water Treatment Plants and Vicinities,
U.S. Marine Corps Base Camp Lejeune, North Carolina**

**Chapter A—Supplement 8
Field Tests, Data Analyses, and Simulation of the Distribution
of Drinking Water with Emphasis on Intermittent Transfers of
Drinking Water Between the Hadnot Point and
Holcomb Boulevard Water-Distribution Systems**

By Jason B. Sautner, Ilker T. Telci, Walter M. Grayman, Morris L. Maslia, and Mustafa M. Aral

Agency for Toxic Substances and Disease Registry
U.S. Department of Health and Human Services
Atlanta, Georgia

March 2013



Authors

Jason B. Sautner, MSCE, EIT

Environmental Health Scientist

Agency for Toxic Substances and Disease Registry
Division of Community Health Investigations
Atlanta, Georgia

Ilker T. Telci, PhD

Post-Graduate Research Fellow

Oak Ridge Institute for Science and Education
Agency for Toxic Substances and Disease Registry
Atlanta, Georgia

Walter M. Grayman, PhD, PE

Consulting Engineer

W.M. Grayman Consulting Engineer
Cincinnati, Ohio

Morris L. Maslia, MSCE, PE, D.WRE, DEE

Research Environmental Engineer and Project Officer

Agency for Toxic Substances and Disease Registry
Division of Community Health Investigations
Exposure-Dose Reconstruction Project
Atlanta, Georgia

Mustafa M. Aral, PhD, PE, Phy

Director and Professor

Georgia Institute of Technology
School of Civil and Environmental Engineering
Multimedia Environmental Simulations Laboratory
Atlanta, Georgia

For additional information write to:

Project Officer
Exposure-Dose Reconstruction Project
Division of Community Health Investigations
Agency for Toxic Substances and Disease Registry
4770 Buford Highway, Mail Stop F-59
Atlanta, Georgia 30341-3717

Suggested citation

Sautner JB, Telci IT, Grayman WM, Maslia ML, and Aral MM. Field Tests, Data Analyses, and Simulation of the Distribution of Drinking Water with Emphasis on Intermittent Transfers of Drinking Water Between the Hadnot Point and Holcomb Boulevard Water-Distribution Systems—Supplement 8. In: Maslia ML, Suárez-Soto RJ, Sautner JB, Anderson BA, Jones LE, Faye RE, Aral MM, Guan J, Jang W, Telci IT, Grayman WM, Bove FJ, Ruckart PZ, and Moore SM. Analyses and Historical Reconstruction of Groundwater Flow, Contaminant Fate and Transport, and Distribution of Drinking Water Within the Service Areas of the Hadnot Point and Holcomb Boulevard Water Treatment Plants and Vicinities, U.S. Marine Corps Base Camp Lejeune, North Carolina—Chapter A: Summary and Findings. Atlanta, GA: Agency for Toxic Substances and Disease Registry; 2013.

Contents

| | |
|---|-------|
| Authors | ii |
| Introduction..... | S8.1 |
| Background..... | S8.2 |
| Water-Distribution Systems..... | S8.6 |
| Field-Testing and Data-Collection Activities—2004 Conditions..... | S8.10 |
| Hadnot Point–Holcomb Boulevard Water Treatment Plant Service Areas, August 2004..... | S8.10 |
| Hazen-Williams Friction Factor (C-Factor) Tests..... | S8.10 |
| Fire-Flow Tests | S8.13 |
| Holcomb Boulevard Water Treatment Plant Service Area, September–October 2004 | S8.18 |
| Sodium Fluoride (NaF) Shutoff and Re-Injection..... | S8.18 |
| Holcomb Boulevard Water Treatment Plant Service Area Test Results | S8.18 |
| Summary of Field Testing and Results..... | S8.25 |
| Estimating Water Consumption—Water Conservation Analysis Methodology | S8.26 |
| Estimating Water Consumption | S8.26 |
| Peak Consumption | S8.27 |
| Aggregate Hourly Demand..... | S8.28 |
| Modeling the Holcomb Boulevard Water-Distribution System—2004 Conditions | S8.30 |
| Model Overview | S8.30 |
| Model Input Requirements..... | S8.30 |
| Junction Data | S8.30 |
| Tank Geometry and Initial Water-Level Data | S8.32 |
| Pipeline Data..... | S8.32 |
| Pumps and Pump Curves..... | S8.32 |
| Pattern Data..... | S8.33 |
| Water-Quality Parameter Data | S8.33 |
| Time Parameter Data | S8.33 |
| Model Calibration—2004 Conditions | S8.34 |
| Hydraulic and Water-Quality Model Calibrations—Holcomb Boulevard | S8.36 |
| Reconstruction of Historical Water-Distribution System Conditions—Holcomb Boulevard..... | S8.41 |
| High-Lift Service Pumps | S8.41 |
| Estimating Demand Patterns | S8.44 |
| Estimating Delivered Finished Water, 1972–1979 | S8.46 |
| Analyses of Interconnection Events and Water Transfers Between the Hadnot Point and Holcomb Boulevard Water-Distribution Systems, 1972–1985..... | S8.51 |
| Connection of Hadnot Point and Holcomb Boulevard Water-Distribution Systems | S8.51 |
| Water Use for Golf Course Irrigation | S8.51 |
| Intermittent Transfers of Finished Water | S8.53 |
| Determining Interconnection Events by Using Markov Analysis | S8.54 |
| Historical Reconstruction Results for Intermittent Transfers of Finished Water | S8.55 |
| Model Sensitivity and Uncertainty..... | S8.63 |
| Sensitivity Analysis..... | S8.63 |
| Uncertainty Analysis | S8.63 |

| | |
|--|--------|
| Discussion..... | S8.66 |
| Summary and Conclusions..... | S8.67 |
| References..... | S8.67 |
| Appendix S8.1. Draft Work Plan Describing Procedures Developed and Methods Used to Collect Hydraulic and Water-Quality Data During Extensive Field Tests | S8.71 |
| Appendix S8.2. Estimated Water Consumption and Building Categories for the Holcomb Boulevard Water Treatment Plant Service Area | S8.159 |
| Appendix S8.3. Estimated Water Demand for the Holcomb Boulevard Water Treatment Plant Service Area | S8.167 |
| Appendix S8.4. Reconstruction of Operational Schedule of Booster Pump 742 Connecting the Hadnot Point and Holcomb Boulevard Water-Distribution Systems, Hadnot Point–Holcomb Boulevard Study Area, U.S. Marine Corps Base Camp Lejeune, North Carolina | S8.171 |
| Appendix S8.5. Reconstructed (Simulated) Mean Concentrations of Tetrachloroethylene (PCE), Trichloroethylene (TCE), <i>trans</i> -1,2-Dichloroethylene (1,2-tDCE), Vinyl Chloride (VC), and Benzene in Finished Water Distributed to Holcomb Boulevard Family Housing Areas, Hadnot Point–Holcomb Boulevard Study Area, U.S. Marine Corps Base Camp Lejeune, North Carolina, 1972–1985..... | S8.187 |
| Appendix S8.6. Variations in Reconstructed (Simulated) Concentrations of Tetrachloroethylene (PCE), Trichloroethylene (TCE), <i>trans</i> -1,2-Dichloroethylene (1,2-tDCE), Vinyl Chloride (VC), and Benzene in Finished Water Distributed to Holcomb Boulevard Family Housing Areas, Hadnot Point–Holcomb Boulevard Study Area, U.S. Marine Corps Base Camp Lejeune, North Carolina, 1972–1985..... | S8.193 |

Figures

| | | |
|--------|---|-------|
| S8.1. | Map showing the Hadnot Point and Holcomb Boulevard water treatment plant (WTP) service areas, Hadnot Point–Holcomb Boulevard study area, U.S. Marine Corps Base Camp Lejeune, North Carolina..... | S8.3 |
| S8.2. | Map showing Hadnot Point water treatment plant (WTP) service area, Hadnot Point–Holcomb Boulevard study area, U.S. Marine Corps Base Camp Lejeune, North Carolina..... | S8.4 |
| S8.3. | Map showing Holcomb Boulevard water treatment plant (WTP) service area, Hadnot Point–Holcomb Boulevard study area, U.S. Marine Corps Base Camp Lejeune, North Carolina..... | S8.5 |
| S8.4. | Schematic diagram of the Holcomb Boulevard water treatment plant (WTP), Hadnot Point–Holcomb Boulevard study area, U.S. Marine Corps Base Camp Lejeune, North Carolina, 2004..... | S8.9 |
| S8.5. | Map showing location of pressure loggers and flow devices used to conduct C-factor tests for the Hadnot Point and Holcomb Boulevard water treatment plant service areas, Hadnot Point–Holcomb Boulevard study area, U.S. Marine Corps Base Camp Lejeune, North Carolina, August 25, 2004..... | S8.11 |
| S8.6. | Photograph showing C-factor test hydrant equipped with WIKA 4-inch, 0–100 psi, manual reading gauge, and Dixon PR300, 0–300 psi, pressure data logger gauge (recording time set to 1-minute intervals on data logger), Hadnot Point–Holcomb Boulevard study area, U.S. Marine Corps Base Camp Lejeune, North Carolina, August 25, 2004..... | S8.12 |
| S8.7. | Photographs showing flowing hydrant with Plant PRO HFD hydrant flow tester (pitot tube with wire-cage diffuser), and debris found in diffuser after conducting C-factor test, Hadnot Point–Holcomb Boulevard study area, U.S. Marine Corps Base Camp Lejeune, North Carolina, August 25, 2004..... | S8.12 |
| S8.8. | Map showing location of pressure loggers and flow devices used to conduct fire-flow tests for the Hadnot Point and Holcomb Boulevard water treatment plant service areas, Hadnot Point–Holcomb Boulevard and Tarawa Terrace study areas, U.S. Marine Corps Base Camp Lejeune, North Carolina, August 25–27, 2004..... | S8.14 |
| S8.9. | Photograph showing flowing hydrant with standard pitot gauge attached to hydrant used to conduct fire-flow test (gauge reads pressure and flow), Hadnot Point–Holcomb Boulevard study area, U.S. Marine Corps Base Camp Lejeune, North Carolina, August 25–27, 2004..... | S8.15 |
| S8.10. | Map showing fire-flow test, Case 1: Midway Park area serviced by Holcomb Boulevard water treatment plant, Hadnot Point–Holcomb Boulevard study area, U.S. Marine Corps Base Camp Lejeune, North Carolina, August 25–27, 2004..... | S8.15 |
| S8.11. | Map showing fire-flow test, Case 2: Hospital Point area serviced by Hadnot Point water treatment plant, Hadnot Point–Holcomb Boulevard study area, U.S. Marine Corps Base Camp Lejeune, North Carolina, August 25–27, 2004..... | S8.16 |
| S8.12. | Map showing fire-flow test, Case 3: Watkins Village area serviced by Holcomb Boulevard water treatment plant, Hadnot Point–Holcomb Boulevard study area, U.S. Marine Corps Base Camp Lejeune, North Carolina, August 25–27, 2004..... | S8.17 |
| S8.13. | Map showing location of fluoride data loggers used for conducting a tracer test of the present-day (2004) Holcomb Boulevard water treatment plant service area, Hadnot Point–Holcomb Boulevard and Tarawa Terrace study areas, U.S. Marine Corps Base Camp Lejeune, North Carolina, September 22–October 12, 2004..... | S8.19 |
| S8.14. | Photograph showing selected field-test equipment: Horiba W-23XD continuous recording, dual-probe ion detector data logger inside flow cell, Hadnot Point–Holcomb Boulevard study area, U.S. Marine Corps Base Camp Lejeune, North Carolina, 2004..... | S8.20 |
| S8.15. | Graphs showing fluoride concentration data for loggers F01 and F02, 15-minute intervals, Holcomb Boulevard water treatment plant service area, Hadnot Point–Holcomb Boulevard study area, U.S. Marine Corps Base Camp Lejeune, North Carolina, September 22–October 12, 2004..... | S8.21 |

| | | |
|--------|--|-------|
| S8.16. | Graphs showing fluoride concentration data for loggers F03 and F04, 15-minute intervals, Holcomb Boulevard water treatment plant service area, Hadnot Point–Holcomb Boulevard study area, U.S. Marine Corps Base Camp Lejeune, North Carolina, September 22–October 12, 2004 | S8.22 |
| S8.17. | Graphs showing fluoride concentration data for loggers F05 and F06, 15-minute intervals, Holcomb Boulevard water treatment plant service area, Hadnot Point–Holcomb Boulevard study area, U.S. Marine Corps Base Camp Lejeune, North Carolina, September 22–October 12, 2004 | S8.23 |
| S8.18. | Graphs showing fluoride concentration data for loggers F07 and F08, 15-minute intervals, Holcomb Boulevard water treatment plant service area, Hadnot Point–Holcomb Boulevard study area, U.S. Marine Corps Base Camp Lejeune, North Carolina, September 22–October 12, 2004 | S8.24 |
| S8.19. | Graph showing fluoride concentration data for logger F09, 15-minute intervals, Holcomb Boulevard water treatment plant service area, Hadnot Point–Holcomb Boulevard study area, U.S. Marine Corps Base Camp Lejeune, North Carolina, September 22–October 12, 2004 | S8.25 |
| S8.20. | Graph showing water delivered and stored at the Holcomb Boulevard water treatment plant service area during the tracer test, Hadnot Point–Holcomb Boulevard study area, U.S. Marine Corps Base Camp Lejeune, North Carolina, September 22–October 12, 2004 | S8.28 |
| S8.21. | Graph showing estimated aggregate water demand for the Holcomb Boulevard water treatment plant service area during the tracer test, Hadnot Point–Holcomb Boulevard study area, U.S. Marine Corps Base Camp Lejeune, North Carolina, September 22–October 12, 2004 | S8.29 |
| S8.22. | Graph showing 24-hour average demand factors for the Holcomb Boulevard water treatment plant service area during the tracer test; obtained by using the water-balance approach, Hadnot Point–Holcomb Boulevard study area, U.S. Marine Corps Base Camp Lejeune, North Carolina, September 22–October 12, 2004..... | S8.29 |
| S8.23. | Map showing location of model nodes and associated demand groups for the Holcomb Boulevard and Tarawa Terrace water-distribution system models, Hadnot Point–Holcomb Boulevard and Tarawa Terrace study areas, U.S. Marine Corps Base Camp Lejeune, North Carolina, 2004 | S8.35 |
| S8.24. | Graph showing measured (SCADA) and simulated hydraulic head in elevated storage tank LCH4004, Holcomb Boulevard water-distribution system model, Hadnot Point–Holcomb Boulevard study area, U.S. Marine Corps Base Camp Lejeune, North Carolina, September 23–26, 2004..... | S8.36 |
| S8.25. | Graph showing measured (SCADA) and simulated hydraulic head in elevated storage tank S2323, Holcomb Boulevard water-distribution system model, Hadnot Point–Holcomb Boulevard study area, U.S. Marine Corps Base Camp Lejeune, North Carolina, September 23–26, 2004..... | S8.37 |
| S8.26. | Graph showing measured (SCADA) and simulated hydraulic head in elevated storage tank S830, Holcomb Boulevard water-distribution system model, Hadnot Point–Holcomb Boulevard study area, U.S. Marine Corps Base Camp Lejeune, North Carolina, September 23–26, 2004 | S8.37 |
| S8.27. | Graph showing measured (ION2, CL Lab, and FOH Lab) and simulated fluoride concentration data at logger F03, Holcomb Boulevard water-distribution system model, Hadnot Point–Holcomb Boulevard study area, U.S. Marine Corps Base Camp Lejeune, North Carolina, September 22–October 12, 2004..... | S8.39 |
| S8.28. | Graph showing measured (ION2, ION3, CL Lab, and FOH Lab) and simulated fluoride concentration data at logger F04, Holcomb Boulevard water-distribution system model, Hadnot Point–Holcomb Boulevard study area, U.S. Marine Corps Base Camp Lejeune, North Carolina, September 22–October 12, 2004..... | S8.39 |
| S8.29. | Graph showing measured (ION2, ION3, CL Lab, and FOH Lab) and simulated fluoride concentration data at logger F06, Holcomb Boulevard water-distribution system model, Hadnot Point–Holcomb Boulevard study area, U.S. Marine Corps Base Camp Lejeune, North Carolina, September 22–October 12, 2004..... | S8.40 |
| S8.30. | Graph showing measured (ION3, CL Lab, and FOH Lab) and simulated fluoride concentration data at logger F08 (Tank S2323), Holcomb Boulevard water-distribution system model, Hadnot Point–Holcomb Boulevard study area, U.S. Marine Corps Base Camp Lejeune, North Carolina, September 22–October 12, 2004..... | S8.40 |

| | |
|---|-------|
| S8.31. Copy of pump curves for Holcomb Boulevard water treatment plant high-lift service pumps #1 and #2, Hadnot Point–Holcomb Boulevard study area, U.S. Marine Corps Base Camp Lejeune, North Carolina, 2004 | S8.42 |
| S8.32. Copy of pump curves for Holcomb Boulevard water treatment plant high-lift service pumps #3 and #4, Hadnot Point–Holcomb Boulevard study area, U.S. Marine Corps Base Camp Lejeune, North Carolina, 2004 | S8.43 |
| S8.33. Graph showing PEST-calibrated and 24-hour average demand factors for the Holcomb Boulevard system-wide pattern (GENERALHB) in the EPANET 2 historical water-distribution system model, Hadnot Point–Holcomb Boulevard study area, U.S. Marine Corps Base Camp Lejeune, North Carolina..... | S8.44 |
| S8.34. Graph showing PEST-calibrated and 24-hour average demand factors for the Midway Park housing area pattern (MIDWAY) in the EPANET 2 historical water-distribution system model, Hadnot Point–Holcomb Boulevard study area, U.S. Marine Corps Base Camp Lejeune, North Carolina | S8.45 |
| S8.35. Graph showing water treatment plant capacity and monthly delivered finished water, in million gallons per day, Hadnot Point–Holcomb Boulevard study area, U.S. Marine Corps Base Camp Lejeune, North Carolina, 1942–2008..... | S8.46 |
| S8.36. Map showing location of Gold and Scarlet Golf Courses in the Holcomb Boulevard water treatment plant service area, Hadnot Point–Holcomb Boulevard study area, U.S. Marine Corps Base Camp Lejeune, North Carolina..... | S8.52 |
| S8.37. Graph showing number of interconnection events when Hadnot Point finished water was transferred to the Holcomb Boulevard water-distribution system, Hadnot Point–Holcomb Boulevard study area, U.S. Marine Corps Base Camp Lejeune, North Carolina, 1972–1986..... | S8.53 |
| S8.38. Maps showing reconstructed (simulated) distribution of trichloroethylene (TCE) contamination within the Holcomb Boulevard water treatment plant service area resulting from supply of contaminated Hadnot Point finished water, Hadnot Point–Holcomb Boulevard study area, U.S. Marine Corps Base Camp Lejeune, North Carolina, June 1978, May 1982, and February 1985..... | S8.58 |
| S8.39. Maps showing reconstructed (simulated) distribution of tetrachloroethylene (PCE) contamination within the Holcomb Boulevard water treatment plant service area resulting from supply of contaminated Hadnot Point finished water, Hadnot Point–Holcomb Boulevard study area, U.S. Marine Corps Base Camp Lejeune, North Carolina, June 1978, May 1982, and February 1985..... | S8.59 |
| S8.40. Maps showing reconstructed (simulated) distribution of <i>trans</i> -1,2-dichloroethylene (1,2-tDCE) contamination within the Holcomb Boulevard water treatment plant service area resulting from supply of contaminated Hadnot Point finished water, Hadnot Point–Holcomb Boulevard study area, U.S. Marine Corps Base Camp Lejeune, North Carolina, June 1978, May 1982, and February 1985..... | S8.60 |
| S8.41. Maps showing reconstructed (simulated) distribution of vinyl chloride (VC) contamination within the Holcomb Boulevard water treatment plant service area resulting from supply of contaminated Hadnot Point finished water, Hadnot Point–Holcomb Boulevard study area, U.S. Marine Corps Base Camp Lejeune, North Carolina, June 1978, May 1982, and February 1985..... | S8.61 |
| S8.42. Maps showing reconstructed (simulated) distribution of benzene contamination within the Holcomb Boulevard water treatment plant service area resulting from supply of contaminated Hadnot Point finished water, Hadnot Point–Holcomb Boulevard study area, U.S. Marine Corps Base Camp Lejeune, North Carolina, June 1978, May 1982, and February 1985..... | S8.62 |
| S8.43. Maps showing variations in reconstructed (simulated) concentrations of trichloroethylene (TCE) contamination at selected locations within the Holcomb Boulevard water treatment plant service area resulting from supply of contaminated Hadnot Point finished water, Hadnot Point–Holcomb Boulevard study area, U.S. Marine Corps Base Camp Lejeune, North Carolina, June 1978, May 1982, and February 1985 | S8.64 |

Tables

| | | |
|--------|--|-------|
| S8.1. | Descriptions and characteristics of elevated storage, Hadnot Point–Holcomb Boulevard and Tarawa Terrace study areas, U.S. Marine Corps Base Camp Lejeune, North Carolina, 2004 | S8.6 |
| S8.2. | Pipe link material types and lengths for the Holcomb Boulevard water-distribution system, Hadnot Point–Holcomb Boulevard study area, U.S. Marine Corps Base Camp Lejeune, North Carolina, 2004 | S8.7 |
| S8.3. | Pipeline material types, nominal diameters, and lengths for the Holcomb Boulevard water-distribution system, Hadnot Point–Holcomb Boulevard study area, U.S. Marine Corps Base Camp Lejeune, North Carolina, 2004 | S8.8 |
| S8.4. | Average monthly flows of finished water, in million gallons per day, Hadnot Point–Holcomb Boulevard and Tarawa Terrace study areas, U.S. Marine Corps Base Camp Lejeune, North Carolina, 2002 and 2004 | S8.8 |
| S8.5. | Population served by the Hadnot Point, Holcomb Boulevard, and Tarawa Terrace water treatment plant service areas, Hadnot Point–Holcomb Boulevard and Tarawa Terrace study areas, U.S. Marine Corps Base Camp Lejeune, North Carolina, 2004 | S8.9 |
| S8.6. | Hazen-Williams C-factor values for the Hadnot Point and Holcomb Boulevard water treatment plant service areas, Hadnot Point–Holcomb Boulevard study area, U.S. Marine Corps Base Camp Lejeune, North Carolina, August 25–27, 2004 | S8.12 |
| S8.7. | Holcomb Boulevard water treatment plant service area water-use inventory, Hadnot Point–Holcomb Boulevard study area, U.S. Marine Corps Base Camp Lejeune, North Carolina, 1998 and 2004 | S8.26 |
| S8.8. | Days of operation per year for different water-use categories, Hadnot Point–Holcomb Boulevard study area, U.S. Marine Corps Base Camp Lejeune, North Carolina, 1998 | S8.27 |
| S8.9. | Holcomb Boulevard water treatment plant service area peak consumption, Hadnot Point–Holcomb Boulevard study area, U.S. Marine Corps Base Camp Lejeune, North Carolina, 2004 | S8.27 |
| S8.10. | Information sources for data and parameter values used to construct models of the water-distribution system serving the Holcomb Boulevard area, Hadnot Point–Holcomb Boulevard study areas, U.S. Marine Corps Base Camp Lejeune, North Carolina | S8.31 |
| S8.11. | Elevated storage tank data for the Holcomb Boulevard water-distribution system model, Hadnot Point–Holcomb Boulevard study area, U.S. Marine Corps Base Camp Lejeune, North Carolina, 2004 | S8.32 |
| S8.12. | Pipe C-factors and materials for the Holcomb Boulevard water-distribution system model, Hadnot Point–Holcomb Boulevard study area, U.S. Marine Corps Base Camp Lejeune, North Carolina, 2004 | S8.33 |
| S8.13. | Root-mean-square error and correlation coefficient for Holcomb Boulevard model results using demand factors from water balance and demand factors from parameter estimation (PEST), Hadnot Point–Holcomb Boulevard study area, U.S. Marine Corps Base Camp Lejeune, North Carolina, 2004 | S8.38 |
| S8.14. | Holcomb Boulevard raw-water and delivered finished-water data sources, Hadnot Point–Holcomb Boulevard study area, U.S. Marine Corps Base Camp Lejeune, North Carolina, 1980–2008 | S8.46 |
| S8.15. | Historical record of total monthly finished water delivered to the Holcomb Boulevard water-distribution system, Hadnot Point–Holcomb Boulevard study area, U.S. Marine Corps Base Camp Lejeune, North Carolina, 1980–2008 | S8.47 |
| S8.16. | Annual number of occupied family housing units in the Holcomb Boulevard housing area, Hadnot Point–Holcomb Boulevard study area, U.S. Marine Corps Base Camp Lejeune, North Carolina, 1972–1984 | S8.48 |

| | |
|---|-------|
| S8.17. Average annual rate of finished water delivered by the Holcomb Boulevard water treatment plant, Hadnot Point–Holcomb Boulevard study area, U.S. Marine Corps Base Camp Lejeune, North Carolina, 1972–2008..... | S8.48 |
| S8.18. Monthly median delivered water percentages used to calculate monthly delivered water volume for 1972–1979, Hadnot Point–Holcomb Boulevard study area, U.S. Marine Corps Base Camp Lejeune, North Carolina, 1980–2008..... | S8.49 |
| S8.19. Holcomb Boulevard water treatment plant estimated and recorded flows, EPANET 2 simulated delivered flows, and EPANET 2 demand multipliers for the months when Hadnot Point finished water was transferred to the Holcomb Boulevard water-distribution system, Hadnot Point–Holcomb Boulevard study area, U.S. Marine Corps Base Camp Lejeune, North Carolina, 1972–1985..... | S8.50 |
| S8.20. Number of recorded and predicted interconnection events when Hadnot Point finished drinking water was transferred to the Holcomb Boulevard water-distribution system, Hadnot Point–Holcomb Boulevard study area, U.S. Marine Corps Base Camp Lejeune, North Carolina, 1972–1985..... | S8.54 |
| S8.21. Reconstructed (simulated) monthly mean percentage of finished Hadnot Point water treatment plant water transferred through booster pump 742 and distributed to Holcomb Boulevard family housing areas for occurrence of interconnection events, Hadnot Point–Holcomb Boulevard study area, U.S. Marine Corps Base Camp Lejeune, North Carolina, 1972–1985..... | S8.56 |
| S8.22. Reconstructed (simulated) mean concentrations of tetrachloroethylene (PCE), trichloroethylene (TCE), <i>trans</i> -1,2-dichloroethylene (1,2-tDCE), vinyl chloride (VC), and benzene in finished water distributed to Holcomb Boulevard family housing areas for selected months, Hadnot Point–Holcomb Boulevard study area, U.S. Marine Corps Base Camp Lejeune, North Carolina, 1972–1985..... | S8.57 |
| S8.23. Reconstructed (simulated) trichloroethylene (TCE) concentrations in finished water distributed to Holcomb Boulevard family housing areas derived from probabilistic analysis using Monte Carlo simulation, Hadnot Point–Holcomb Boulevard study area, U.S. Marine Corps Base Camp Lejeune, North Carolina, June 1978, May 1982, and February 1985..... | S8.65 |
| S8.24. Reconstructed (simulated) trichloroethylene (TCE) concentrations in finished water at selected locations within Holcomb Boulevard family housing areas derived from probabilistic analysis using Monte Carlo simulation, Hadnot Point–Holcomb Boulevard study area, U.S. Marine Corps Base Camp Lejeune, North Carolina, June 1978, May 1982, and February 1985..... | S8.65 |

See the Chapter A report for conversion factors and definitions of terms and abbreviations used throughout this supplement.

Use of trade names and commercial sources is for identification only and does not imply endorsement by the Agency for Toxic Substances and Disease Registry or the U.S. Department of Health and Human Services.

Analyses and Historical Reconstruction of Groundwater Flow, Contaminant Fate and Transport, and Distribution of Drinking Water Within the Service Areas of the Hadnot Point and Holcomb Boulevard Water Treatment Plants and Vicinities, U.S. Marine Corps Base Camp Lejeune, North Carolina

Chapter A—Supplement 8

Field Tests, Data Analyses, and Simulation of the Distribution of Drinking Water with Emphasis on Intermittent Transfers of Drinking Water Between the Hadnot Point and Holcomb Boulevard Water-Distribution Systems

By Jason B. Sautner,¹ Ilker T. Telci,² Walter M. Grayman,³ Morris L. Maslia,¹ and Mustafa M. Aral⁴

Introduction⁵

This supplement of Chapter A (Supplement 8) describes the field testing, data analyses, and simulation of the distribution of finished water⁶ with emphasis on intermittent transfers of finished water between the Hadnot Point and Holcomb Boulevard water-distribution systems. The information, data, and analyses presented in this supplement are part of the historical reconstruction process being applied to reconstruct finished-water concentrations of selected volatile organic compounds (VOCs). Historical reconstruction is being used to support health studies being conducted by the Agency for Toxic Substances and Disease Registry (ATSDR) at U.S. Marine Corps Base Camp Lejeune, North Carolina (hereinafter referred to as USMCB Camp Lejeune). To complete the health studies, estimates or direct knowledge of monthly mean concentrations of selected VOCs in finished water supplied by the Hadnot Point water treatment plant

(HPWTP) and Holcomb Boulevard water treatment plant (HBWTP) to housing areas and other facilities are necessary. An issue that complicates the estimation of historical finished-water concentrations is that the Holcomb Boulevard water-distribution system was not directly contaminated at its water treatment plant (WTP). Rather, VOC-contaminated HPWTP finished water was intermittently transferred to the Holcomb Boulevard water-distribution system serving family housing areas and other facilities. In this study, some of the operational periods of interconnection between 1972 and 1985 are documented while others were estimated using Markov-Chain analysis. Extended period simulations (EPSs) using the EPANET 2 water-distribution system model were used to reconstruct water-distribution system characteristics during spring and summer months of interconnection events. Results are presented for the spatial distribution of contaminated finished water within the “uncontaminated” HBWTP service area for VOCs of concern.⁷

¹ Agency for Toxic Substances and Disease Registry, Atlanta, Georgia.

² Oak Ridge Institute for Science and Education, Oak Ridge, Tennessee; formerly with Georgia Institute of Technology, School of Civil and Environmental Engineering, Atlanta, Georgia.

³ W.M. Grayman, Consulting Engineer, Cincinnati, Ohio.

⁴ Georgia Institute of Technology, School of Civil and Environmental Engineering, Atlanta, Georgia.

⁵ Because this supplement of Chapter A (Supplement 8) describes data and information related to 2004 and historical conditions of water-distribution systems at USMCB Camp Lejeune, data, maps, and specific location coordinates were required and used in conducting field tests, analyzing data, and conducting water-distribution system modeling. Subsequent to these activities, the National Center for Environmental Health—Agency for Toxic Substances and Disease Registry (NCEH-ATSDR) issued a Standard Operating Procedure on Release of Active Public Drinking Water Supply Wells and Surface Water Intakes Locations (Christopher J. Portier, NCEH-ATSDR, electronic communication, June 28, 2012). Therefore, maps contained in this Supplement 8 report do not show pipelines or other hydraulic appurtenances such as hydrant coordinate locations used during field tests, data analyses, and water-distribution system modeling. Readers requiring location information should contact the NCEH-ATSDR Office of the Director.

⁶ For this study, finished water is defined as groundwater (or raw water) that has undergone treatment at a WTP and is delivered to a person’s home or other facility.

⁷ VOCs of concern for this study are: tetrachloroethylene (PCE), trichloroethylene (TCE), *trans*-1,2-dichloroethylene (1,2-tDCE), vinyl chloride (VC), and benzene; see Maslia et al. (2013) for details.

Background

USMCB Camp Lejeune is located in the Coastal Plain of North Carolina, in Onslow County, south of the City of Jacksonville and about 70 miles northeast of the City of Wilmington, North Carolina (Figure S8.1). The area of investigations reported herein is inclusive of the water-distribution networks supplied by the HPWTP and HBWTP (Faye et al. 2010, Plate 1), herein called the study area or the Hadnot Point–Holcomb Boulevard (HPHB) study area. In general, the study area is bordered on the north by Northeast Creek and North Carolina Highway 24 (SR24), to the west by New River, to the south by Frenchs Creek, and generally to the east by the drainage divides of the upstream tributaries of Wallace Creek and Frenchs Creek (Figure S8.1). Total study area is approximately 50 square miles (mi²).⁸

The historical reconstruction of contaminant fate and transport in groundwater of the Tarawa Terrace base housing area of USMCB Camp Lejeune and historical finished-water concentrations supplied by the Tarawa Terrace WTP (TTWTP) have been extensively studied by ATSDR. Those studies, analyses, and results are described in previous reports.⁹ Current studies (2010 and thereafter) focus on historical reconstruction of contaminant concentrations in groundwater and finished water in the HPHB study area. This reconstruction process requires gathering information about the groundwater system, characterization of contaminant sources, and simulation of contaminant fate and transport in the groundwater system and

⁸ Although the area of interest for this Supplement 8 report is the HPHB study area, water-distribution system field testing, data collection, and data analyses also include the Tarawa Terrace study area. Therefore, for discussion and presentation purposes, some information pertinent to the Tarawa Terrace study area is included in this Supplement 8 report. Additional data and analyses specific to the Tarawa Terrace water-distribution system are presented in Maslia et al. (2009).

⁹ The Tarawa Terrace study area reports are available on the ATSDR Camp Lejeune Web site at: <http://www.atsdr.cdc.gov/sites/lejeune/index.html>.

the water-distribution systems serving the HPHB study area. The WTPs serving the study area obtained groundwater from 96 water-supply wells distributed in the Hadnot Point and Holcomb Boulevard areas and the east side of USMCB Camp Lejeune (Figure S8.1).¹⁰

The focus of the ATSDR health studies is on exposure to contaminated finished water provided by water-distribution systems that historically served base housing and other facilities at Hadnot Point (Figure S8.2), Camp Johnson/Montford Point, Tarawa Terrace, and Holcomb Boulevard (Figure S8.3). Currently (2013), there are two operating WTPs that provide finished water for the distribution systems of interest to the health studies: (1) the HPWTP that services the Hadnot Point area of the distribution system (Figure S8.2), and (2) the HBWTP that services the Camp Johnson, Tarawa Terrace, and Holcomb Boulevard areas of the distribution system (Figure S8.3).

Analysis of the water-distribution systems is complex and challenging because of historical changes in system configuration and operations. Hadnot Point was the original WTP (beginning operations around 1942) and serviced the entire Base at one time (Faye et al. 2010). The TTWTP began operations during the early 1950s and historically serviced the Tarawa Terrace and Camp Johnson/Montford Point areas (Maslia et al. 2007). The HBWTP began operations around June 1972 (Scott A. Brewer, USMCB Camp Lejeune, written communication, September 29, 2005) to help meet increasing system demands. After the TTWTP was shut down during 1987 because of contaminated water-supply wells, the HBWTP was used to service the Holcomb Boulevard, Tarawa Terrace, and Camp Johnson/Montford Point areas (Maslia et al. 2007). At present, there is a finished-water reservoir (ground storage tank STT39) at Tarawa Terrace (Figure S8.3) that receives finished water directly from the HBWTP.

¹⁰ See Maslia et al. (2013), Sautner et al. (2013), and Telci et al. (2013) for detailed descriptions of and discussions about the 96 water-supply wells.

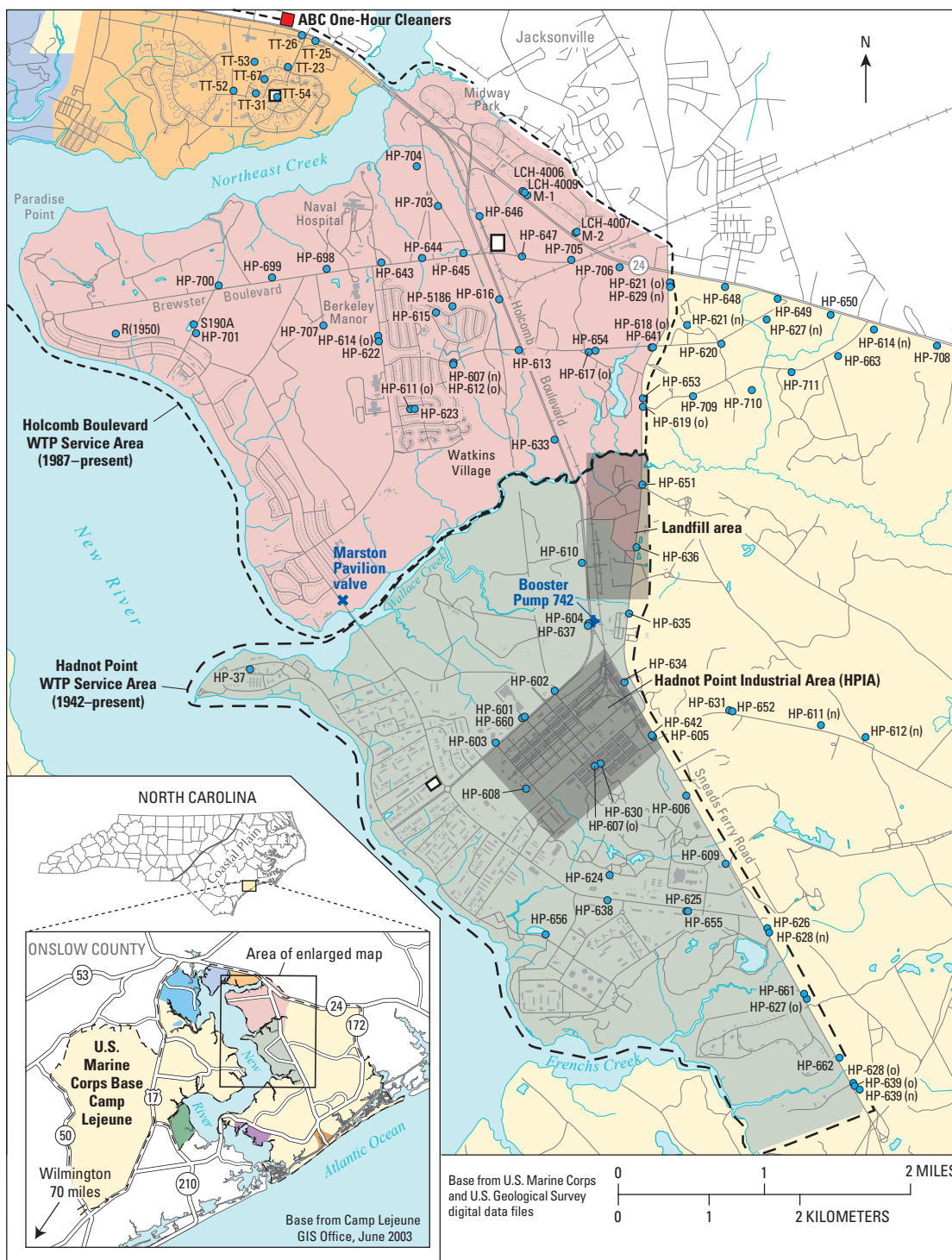
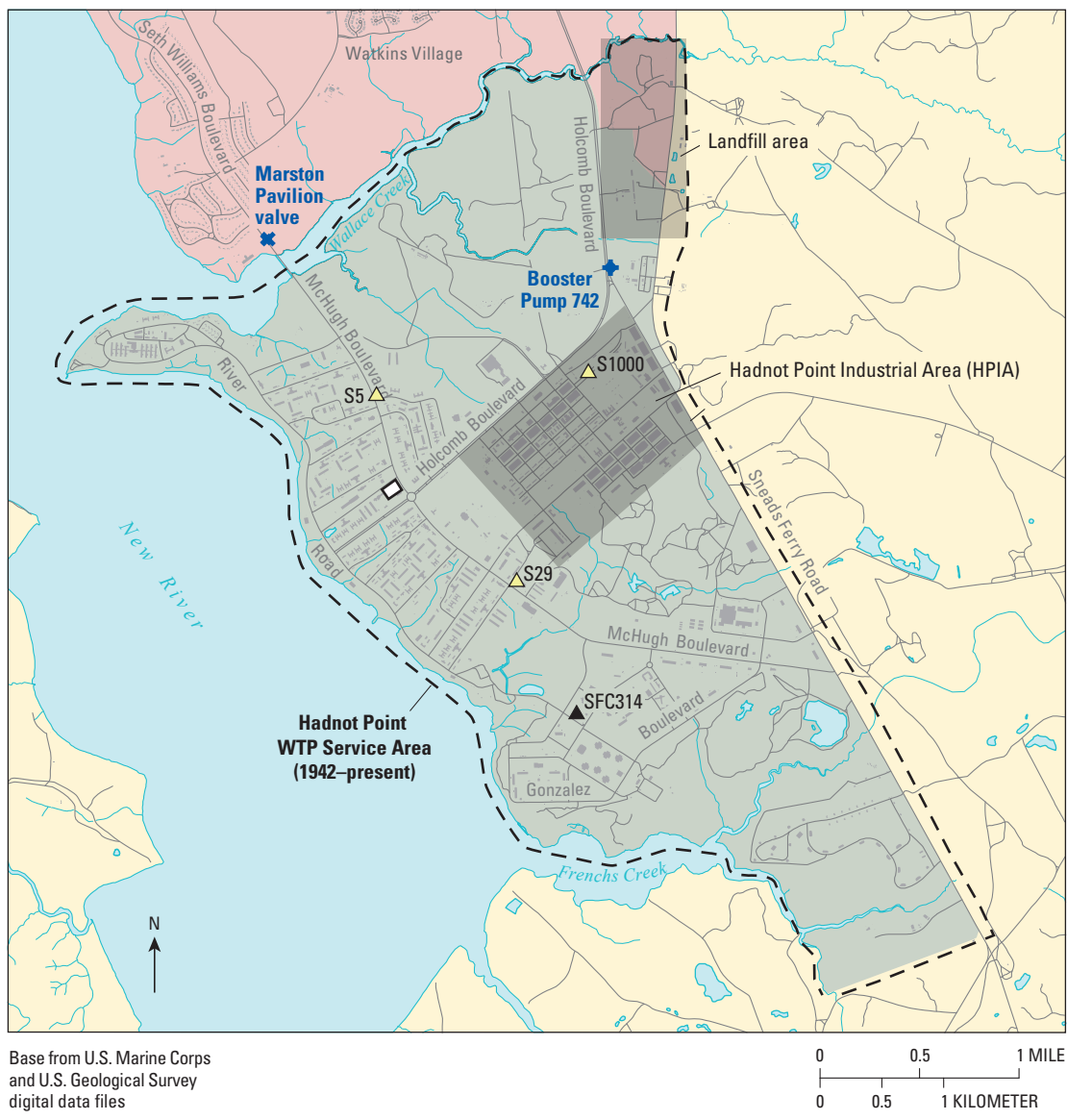

Figure S8.1. The Hadnot Point and Holcomb Boulevard water treatment plant (WTP) service areas, Hadnot Point–Holcomb Boulevard study area, U.S. Marine Corps Base Camp Lejeune, North Carolina.



Base from U.S. Marine Corps and U.S. Geological Survey digital data files

EXPLANATION

- | | | |
|---|--|---|
| <p>Historical water-supply areas of Camp Lejeune Military Reservation</p> <ul style="list-style-type: none"> Holcomb Boulevard Hadnot Point Other areas of Camp Lejeune Military Reservation | <p>Storage tank and identifier</p> <ul style="list-style-type: none"> SFC314 Elevated—Controlling S5 Elevated | <p>Water treatment plant—Name and length of operation</p> <ul style="list-style-type: none"> Hadnot Point: 1942–present |
|---|--|---|

Figure S8.2. Hadnot Point water treatment plant (WTP) service area, Hadnot Point–Holcomb Boulevard study area, U.S. Marine Corps Base Camp Lejeune, North Carolina.

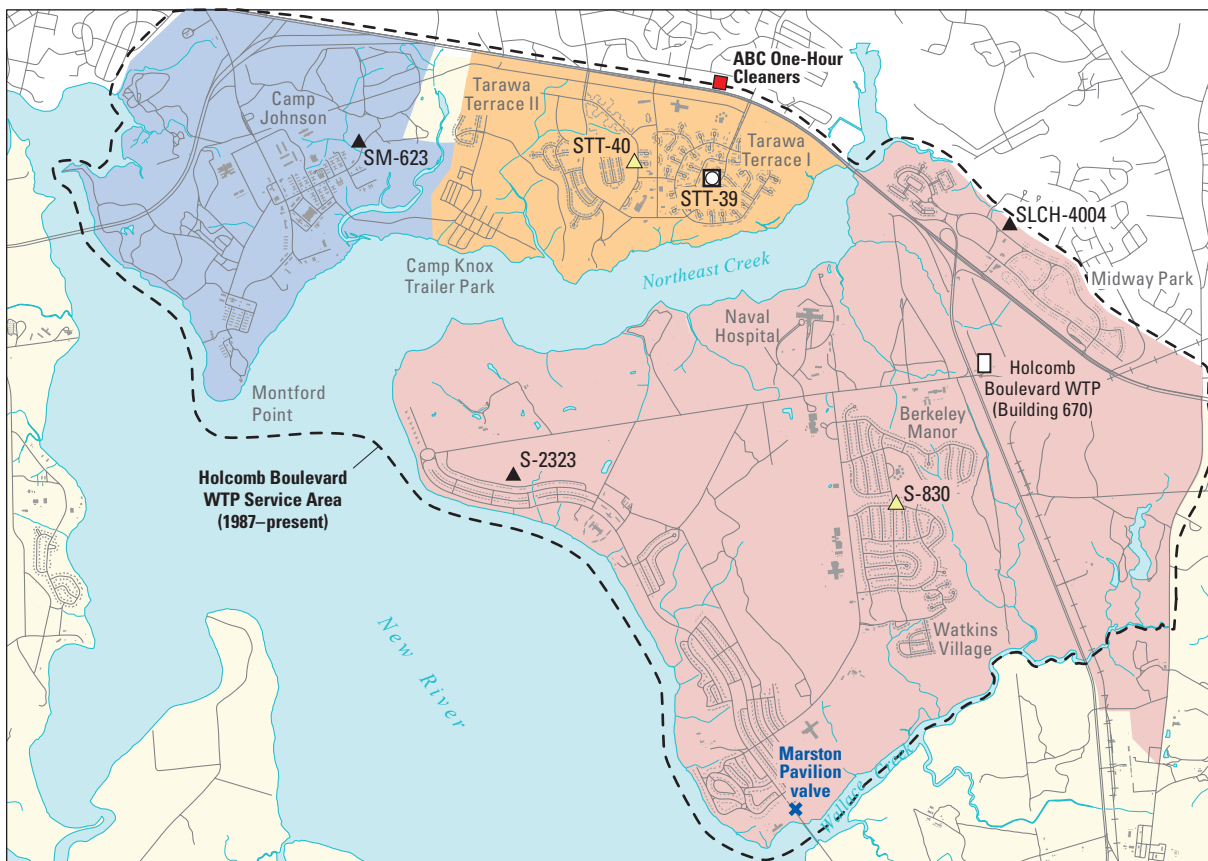

Base from U.S. Marine Corps digital data files

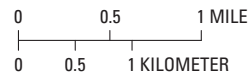

EXPLANATION

- | | | | |
|---|--|---|--|
| Historical water-supply areas of Camp Lejeune Military Reservation | | Storage tank and identifier | |
| Montford Point | | S2323 Elevated—Controlling | |
| Tarawa Terrace | | S830 Elevated | |
| Holcomb Boulevard | | STT39 Ground—Finished water | |
| Hadnot Point | | | |
| Other areas of Camp Lejeune Military Reservation | | Water treatment plant— | |
| | | Name and length of operation | |
| | | Holcomb Boulevard: June 1972–present | |
| | | Tarawa Terrace: 1952–1987 | |

Figure S8.3. Holcomb Boulevard water treatment plant (WTP) service area, Hadnot Point–Holcomb Boulevard study area, U.S. Marine Corps Base Camp Lejeune, North Carolina.

Water-Distribution Systems

There are nine elevated storage tanks in the HPWTP and HBWTP service areas (Figures S8.2 and S8.3). The range in water-level fluctuation for the elevated storage tanks is small—generally 1–7 feet (ft) according to March 2004 and September–October 2004 data (Table S8.1). Three of the elevated storage tanks—SM623, S2323, and SFC314—operate as controlling tanks (Figures S8.2 and S8.3). When demand causes water levels in these controlling tanks to drop below a minimum water level, high-lift pumps are turned on at the HBWTP or at the Tarawa Terrace finished-water reservoir to fill the controlling elevated storage tanks to a maximum water level. The pumps are then shut off.

The Holcomb Boulevard water-distribution system contains 386,395 ft (about 73 miles) of pipeline. Tables S8.2 and S8.3 list pipeline lengths, material types, and pipeline diameters for the Holcomb Boulevard (2004) water-distribution system. Although five different material types are used for distribution system pipelines, cast iron composes about 66% of all pipeline materials.

The average annual flows for 2002 and 2004 for finished water at the HBWTP were 1.58 and 1.46 million gallons per day (MGD), respectively. A portion of the finished water from the HBWTP is delivered to the Tarawa Terrace ground storage reservoir (STT39). For 2004, this amounted to 0.80 MGD or about 55% of the total water treated at the HBWTP. For 2002, the amount of finished water delivered from the HBWTP to

Table S8.1. Descriptions and characteristics of elevated storage, Hadnot Point–Holcomb Boulevard and Tarawa Terrace study areas, U.S. Marine Corps Base Camp Lejeune, North Carolina, 2004.

[N/A, not available due to instrumentation reading failures]

| Storage tank parameter, in feet | Hadnot Point water treatment plant service area (Figure S8.2) | | | |
|------------------------------------|---|---------------------------------------|---------------------------|---------------------------------------|
| | S5 | S29 | Industrial Area: S1000 | Frenchs Creek: SFC314 ¹ |
| Elevation, bottom of tank | 126.3 | 125.3 | 127.4 | 134.8 |
| Maximum water level ² | 28.4 | 28.6 | 29.2 | 25.0 |
| Minimum water level ² | 27.5 | 27.1 | 26.8 | 20.3 |
| Water-level difference | 0.9 | 1.5 | 2.4 | 4.7 |
| Storage tank parameter, in feet | Holcomb Boulevard water treatment plant service area (Figure S8.3) | | | |
| | Paradise Point: S2323 ³ | Berkeley Manor: S830 | Midway Park: LCH4004 | |
| Elevation, bottom of tank | 130.4 | 127.5 | 129.9 | |
| Maximum water level ² | 31.0 | 32.4 | 30.1 | |
| Minimum water level ² | 27.6 | 30.0 | 25.9 | |
| Water-level difference | 3.4 | 2.4 | 4.2 | |
| Storage tank parameter, in feet | Tarawa Terrace service area (Figure S8.3) | | | |
| | Camp Johnson: SM623 ⁴ | Tarawa Terrace: STT40 ⁵ | | |
| Elevation, bottom of tank | 128.0 | 115.0 | | |
| Maximum water level ⁶ | N/A | 31.7 | | |
| Minimum water level ⁶ | N/A | 24.9 | | |
| Water-level difference | N/A | 6.8 | | |

¹ Controlling tank for Hadnot Point water treatment plant

² Data from Camp Lejeune water utility department, March 1–7, 2004

³ Controlling tank for Holcomb Boulevard water treatment plant

⁴ Controlling tank for Tarawa Terrace finished-water reservoir

⁵ Controlling tank for Tarawa Terrace finished-water reservoir due to instrumentation reading failures of SM623 water levels during September–October 2004

⁶ Data from Camp Lejeune water utility department, September 22–October 12, 2004

STT39 is not known. Average monthly flows of finished water for 2002 and 2004 for the HBWTP are listed in Table S8.4. These data represent finished water delivered from the HBWTP to the distribution system network. Because USMCB Camp Lejeune is a military installation, the Base does not require or install water consumption meters on housing units or other facilities. Other water-consumption facilities on Base, such as car washes, swimming pools, and office buildings, with the exception of base power plants, also are not metered. Thus, data quantifying water-distribution system consumption and directions of flows are not available because of the absence of housing and network flow meters and recorded water usage.

In 2004, the population served by the Holcomb Boulevard water-distribution system was 223 in the bachelor housing areas and 6,873 in the family housing areas (Table S8.5). Worker population is not included in these data. Nearly all family housing is located in the Holcomb Boulevard and Tarawa Terrace areas (99%), whereas most of the bachelor housing is located in the Hadnot Point area (85%).

Groundwater is the sole source for water supply at USMCB Camp Lejeune. All raw water¹¹ is supplied from water-supply wells pumping from the Tarawa Terrace aquifer

¹¹ In this study, raw water is defined as groundwater withdrawn by water-supply wells that has not been through a treatment process.

and Castle Hayne aquifer system that underlie the Base (Table A11; Telci et al. 2013).¹² Raw-water concentrations of chloride and fluoride are 0.14 and 0.2 milligram per liter (mg/L), respectively (B.T. Ashton, USMCB Camp Lejeune Environmental Management Division, electronic communication, April 6, 2004). The raw water is treated with chlorine, lime, and sodium fluoride (NaF) at the WTP; a schematic diagram of the HBWTP is shown in Figure S8.4. As a consequence of the treatment process, finished water has a chloride concentration of 20 mg/L (B.T. Ashton, USMCB Camp Lejeune Environmental Management Division, electronic communication, March 31, 2004). The addition of lime to the treatment process (Figure S8.4) causes the pH of the finished water to be high—about 8.5–9. NaF crystals are added to the treatment process by using a gravity-feed saturator system to fluoridate the water. The concentration of fluoride in finished water within the Holcomb Boulevard water-distribution system, including elevated storage tanks, has an average value of about 1 mg/L (D.E. Hill, USMCB Camp Lejeune Public Works Department Utility Section, written communication, May 2004).

¹² When referring to figures, tables, and appendixes in the Chapter A report (e.g., Table A11), it should be understood that reference is being made to those report items in Maslia et al. (2013).

Table S8.2. Pipe link material types and lengths for the Holcomb Boulevard water-distribution system, Hadnot Point–Holcomb Boulevard study area, U.S. Marine Corps Base Camp Lejeune, North Carolina, 2004.¹

| Material type | Number of pipe links | Percentage of pipe links | Total length, in feet | Percentage of total length |
|--------------------------|----------------------|--------------------------|-----------------------|----------------------------|
| Cast iron (CI) | 3,240 | 66.0 | 260,006 | 67.3 |
| Ductile iron (DI) | 1 | 0.0 | 8,761 | 2.3 |
| Polyvinyl chloride (PVC) | 81 | 1.7 | 9,726 | 2.5 |
| Asbestos cement (AC) | 311 | 6.3 | 27,362 | 7.1 |
| Copper (CU) | 1,276 | 26.0 | 80,540 | 20.8 |
| Total | 4,909 | 100.0 | 386,395 | 100.0 |

¹ Modified from AH Environmental Consultants, electronic communication, 2004

Table S8.3. Pipeline material types, nominal diameters, and lengths for the Holcomb Boulevard water-distribution system, Hadnot Point–Holcomb Boulevard study area, U.S. Marine Corps Base Camp Lejeune, North Carolina, 2004.¹

[AC, asbestos cement; CI, cast iron; CU, copper; DI, ductile iron; PVC, polyvinyl chloride; —, not applicable]

| Nominal diameter, in inches | Pipeline length, in feet ² | | | | | Total length, in feet |
|-----------------------------|---------------------------------------|----------------|---------------|--------------|--------------|-----------------------|
| | AC | CI | CU | DI | PVC | |
| 0.75 | 248 | — | 100 | — | 634 | 982 |
| 1 | — | 2,626 | 67,242 | — | 1,378 | 71,246 |
| 1.5 | — | 71 | 1,870 | — | — | 1,941 |
| 2 | — | 36,459 | 10,982 | — | 88 | 47,529 |
| 3 | 3,270 | 4,800 | — | — | 192 | 8,262 |
| 4 | — | 23,729 | 346 | — | 41 | 24,116 |
| 6 | 1,781 | 60,253 | — | — | 2,940 | 64,974 |
| 8 | 8,217 | 68,313 | — | — | 4,301 | 80,832 |
| 10 | 9,909 | 11,731 | — | — | 72 | 21,713 |
| 12 | 3,508 | 41,986 | — | — | 79 | 45,573 |
| 16 | 17 | 10,036 | — | — | — | 10,053 |
| 24 | 412 | — | — | 8,761 | — | 9,174 |
| Total | 27,362 | 260,006 | 80,540 | 8,761 | 9,726 | 386,395 |

¹ Modified from AH Environmental Consultants, electronic communication, 2004

² Rounded values

Table S8.4. Average monthly flows of finished water, in million gallons per day, Hadnot Point–Holcomb Boulevard and Tarawa Terrace study areas, U.S. Marine Corps Base Camp Lejeune, North Carolina, 2002 and 2004.

[HBWTP, Holcomb Boulevard water treatment plant; WDS, water-distribution system]

| Month | Total water delivered, 2002 ¹ | | Total water delivered, 2004 ² | |
|--------------------|--|-------------|--|---------------------------------------|
| | From HBWTP | From HBWTP | To Tarawa Terrace Reservoir ³ | To Holcomb Boulevard WDS ³ |
| January | 1.66 | 1.55 | 0.82 | 0.73 |
| February | 1.61 | 1.58 | 0.74 | 0.84 |
| March | 1.52 | 1.46 | 0.70 | 0.76 |
| April | 1.68 | 1.49 | 0.77 | 0.72 |
| May | 1.74 | 1.68 | 0.89 | 0.79 |
| June | 1.77 | 1.58 | 0.86 | 0.72 |
| July | 1.56 | 1.44 | 0.78 | 0.66 |
| August | 1.61 | 1.45 | 0.84 | 0.61 |
| September | 1.52 | 1.36 | 0.95 | 0.40 |
| October | 1.40 | 1.35 | 0.81 | 0.55 |
| November | 1.38 | 1.30 | 0.73 | 0.57 |
| December | 1.53 | 1.28 | 0.74 | 0.54 |
| Annual mean | 1.58 | 1.46 | 0.80 | 0.66 |

¹ Data from Camp Lejeune water department, 2004

² Data from S.J. Whited, Camp Lejeune water department, electronic communication, January 31, 2005

³ Tarawa Terrace reservoir water is treated at the HBWTP; the sum of the Holcomb Boulevard and Tarawa Terrace flows is total delivered water from HBWTP. The flows to Tarawa Terrace reservoir and to the Holcomb Boulevard WDS for 2002 are not available

Table S8.5. Population served by the Hadnot Point, Holcomb Boulevard, and Tarawa Terrace water treatment plant service areas, Hadnot Point–Holcomb Boulevard and Tarawa Terrace study areas, U.S. Marine Corps Base Camp Lejeune, North Carolina, 2004.^{1,2}

| Water treatment plant service area | Bachelor housing ³ | Family housing | Total |
|------------------------------------|-------------------------------|----------------|---------------|
| Hadnot Point | 10,468 | 76 | 10,544 |
| Holcomb Boulevard | 223 | 6,873 | 7,096 |
| Tarawa Terrace | 1,648 | 4,618 | 6,266 |
| Total | 12,339 | 11,567 | 23,906 |

¹ Information and data were provided to ATSDR following telephonic requests and oral discussions between ATSDR staff and U.S. Marine Corps Base Camp Lejeune Environmental Management Division and water utility staff

² Excludes civilian worker population

³ Includes permanent and transient military personnel

Maslia et al. (2000, 2001, 2005) demonstrated that data and information on the configuration and operation of a present-day water-distribution system are useful for estimating historical operational characteristics of the same water-distribution system. To accomplish this, data and information pertinent to a present-day water-distribution system configuration and operation need to be gathered and analyzed so that input data for water-distribution system models can be developed to reconstruct historical system operations. For this study a “present-day” system is characterized by conditions existing during 2004. To obtain information and data for 2004 system conditions, a field-testing program was designed by ATSDR in cooperation with USMCB Camp Lejeune. These data and information were used to develop and calibrate water-distribution system models to assist with the historical reconstruction effort. The field-testing and data collection activities are described in detail in the next report section.

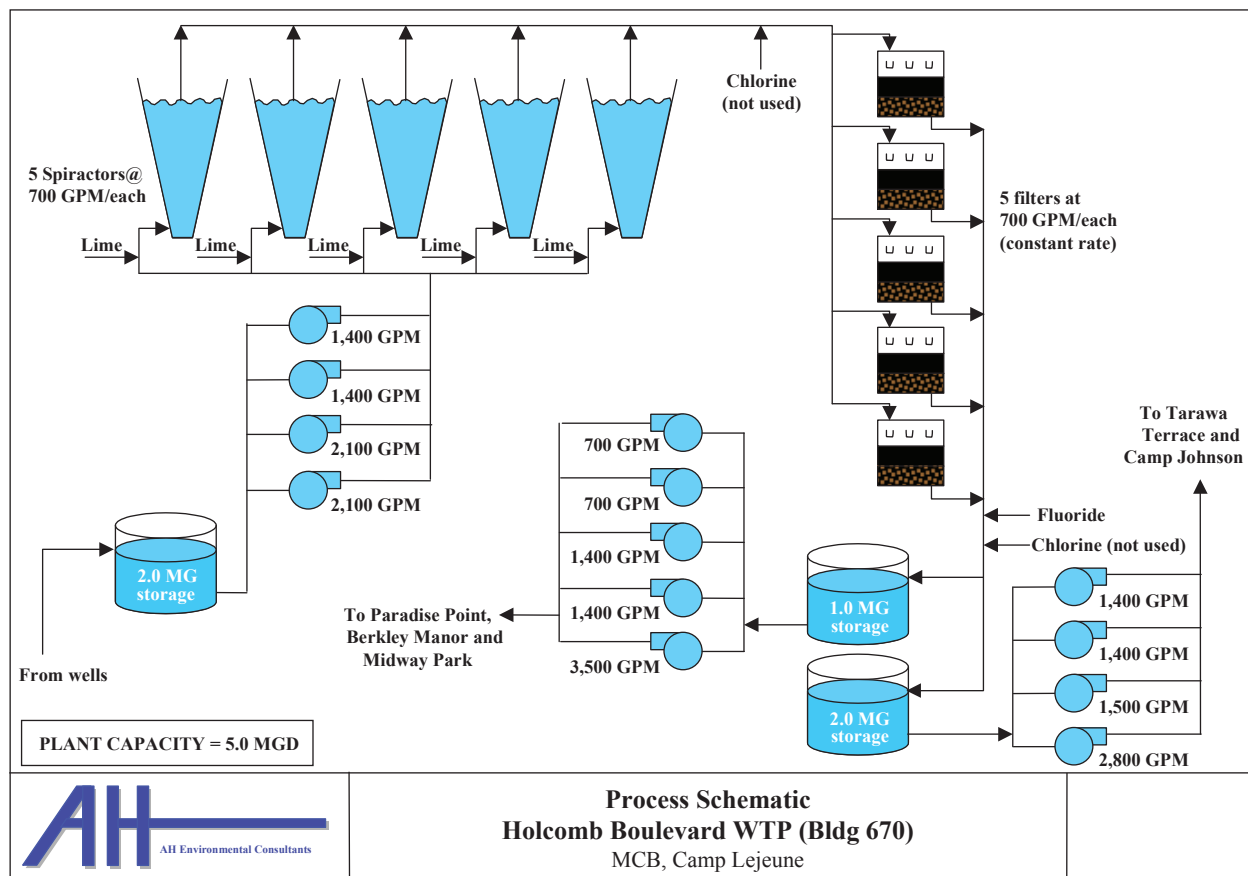

Figure S8.4. Schematic diagram of the Holcomb Boulevard water treatment plant (WTP), Hadnot Point–Holcomb Boulevard study area, U.S. Marine Corps Base Camp Lejeune, North Carolina, 2004 (from A.H. Environmental Consultants 2001).

Field-Testing and Data-Collection Activities—2004 Conditions

ATSDR reviewed and analyzed hydraulic and water-quality data, system operations, and a water conservation study of the Base (ECG, Inc. 1999). Based on this review and discussions with water utility staff, ATSDR began a field-testing program, in cooperation with USMCB Camp Lejeune, to obtain data necessary to develop and calibrate water-distribution models that represent 2004 conditions. As part of this effort, ATSDR conducted hydraulic (pressure and flow) and water-quality (tracer) tests in the HPWTP and HBWTP service areas, which included Tarawa Terrace and Camp Johnson/Montford Point (Figure S8.5). Tracer tests consisted of injecting calcium chloride (CaCl₂) and NaF into the water-distribution system and turning WTP fluoride feeds off and on. Test details are described in Maslia et al. (2004, 2005) and Sautner et al. (2005). During initial tracer-test injection activities (May 2004), observations indicated that finished water in some storage tanks apparently did not mix completely or uniformly. It was not logistically possible to monitor the internal mixing patterns of the Camp Lejeune storage tanks. Therefore, in subsequent field tests, controlling storage tanks (Figure S8.5) were equipped with continuous recording water-quality monitoring equipment. The monitoring equipment was connected to the inlet and outlet of the storage tanks so that fill and drain patterns of the storage tanks could be continuously recorded and monitored at 15-minute (min) intervals. For a more detailed discussion on tank mixing see Sautner et al. (2007) and Maslia et al. (2009). These and other tests provided ATSDR with sufficient data to calibrate water-distribution system models representing 2004 system conditions. A detailed draft work plan describing the methods used and procedures developed to collect hydraulic and water-quality data (pressure, hydraulic head, tank level, CaCl₂, and NaF) during these extensive field tests is provided in Appendix S8.1.

Hadnot Point–Holcomb Boulevard Water Treatment Plant Service Areas, August 2004

A field test was conducted of the HPWTP and HBWTP service areas during August 25–27, 2004. The purpose of this test was to obtain hydraulic data to compute roughness coefficient (Hazen-Williams C-factor) values—a parameter required for model input and calibration. The test consisted of two activities:

1. Testing different pipeline sections of varying lengths, diameters, and material types to collect hydraulic data for calculating roughness coefficients (Hazen-Williams C-factor data), and
2. Applying an innovative approach for fire-flow testing (for model calibration purposes) using continuous recording pressure monitoring equipment at several fire hydrants simultaneously while different combinations of hydrants were flowed.

Hazen-Williams Friction Factor (C-Factor) Tests

Eight sections of pipelines, characterized by three different pipe materials (cast iron, polyvinyl chloride [PVC], and asbestos cement), were tested on August 25, 2004 (Figure S8.5). Three hydrants located along the same pipeline are required to conduct a C-factor test. Two hydrants are equipped with pressure gauges (Figure S8.6), and a third hydrant is equipped with a flow- and pressure-measuring device containing a pitot tube and pressure gauge (Figure S8.7). The hydrant equipped with the pitot-tube device is flowed, and the pressure is recorded in the upgradient adjacent two hydrants equipped with pressure gauges. Using these hydrants, the head drop between the two hydrants equipped with the pressure gauges can be computed. Knowing the flow from the third hydrant and the distance over which the head drop occurs, the C-factor for the section of pipeline being tested is computed. More detailed descriptions of C-factor testing methods are provided in Walski et al. (2003). Typically, manual reading gauges, such as the WIKA 4-inch (in.) gauge with a 0–100 pounds per square inch (psi) scale and 1-psi increments are used (Figure S8.6A). However, for quality-assurance and quality-control (QA/QC) purposes and to be able to record pressures in 1-min intervals, test hydrants also were equipped with the Dixon PR300 pressure data logger gauge (Figure S8.6B). To record flow and pressure from flowed hydrants, the Plant PRO HFD hydrant flow tester with a diffuser was used (Figure S8.7A). Note, debris within pipelines can affect results of C-factor tests (Figure S8.7B).¹³

For the tested pipelines: (1) diameters ranged from 6 in. to 12 in., (2) lengths ranged from 700 ft to 1,672 ft, and (3) flows ranged from 564 gallons per minute (gpm) to 1,603 gpm. By using the hydraulic data gathered during the August 2004 field-tests, Hazen-Williams C-factor values were computed for the eight sections of tested pipelines and are listed in Table S8.6. The results for PVC and cast iron show good agreement between the C-factor values determined from the field-testing activities and those in the published literature (Cesario 1995; Walski et al. 2003). The flow-weighted mean of the two C-factor tests conducted on PVC-type pipelines is 132, compared with a literature value of 147. The flow-weighted mean of the four C-factor tests conducted on cast iron pipelines is 87, compared with literature values of 97–102. As cast iron pipe ages, C-factors tend to decrease (Walski 1992). Thus, the calculated C-factor value of 87 probably indicates that older cast iron pipes were tested. The C-factor test results for asbestos cement pipelines showed inconsistencies with those in published literature. The high computed C-factor of 190 for asbestos cement pipes was most likely the result of not achieving sufficient head loss during the field test. As a result, a published literature value of 150 was used in subsequent model calibration analyses to represent asbestos cement pipelines.

¹³See Appendix S8.1 for more details and photographs of test equipment.

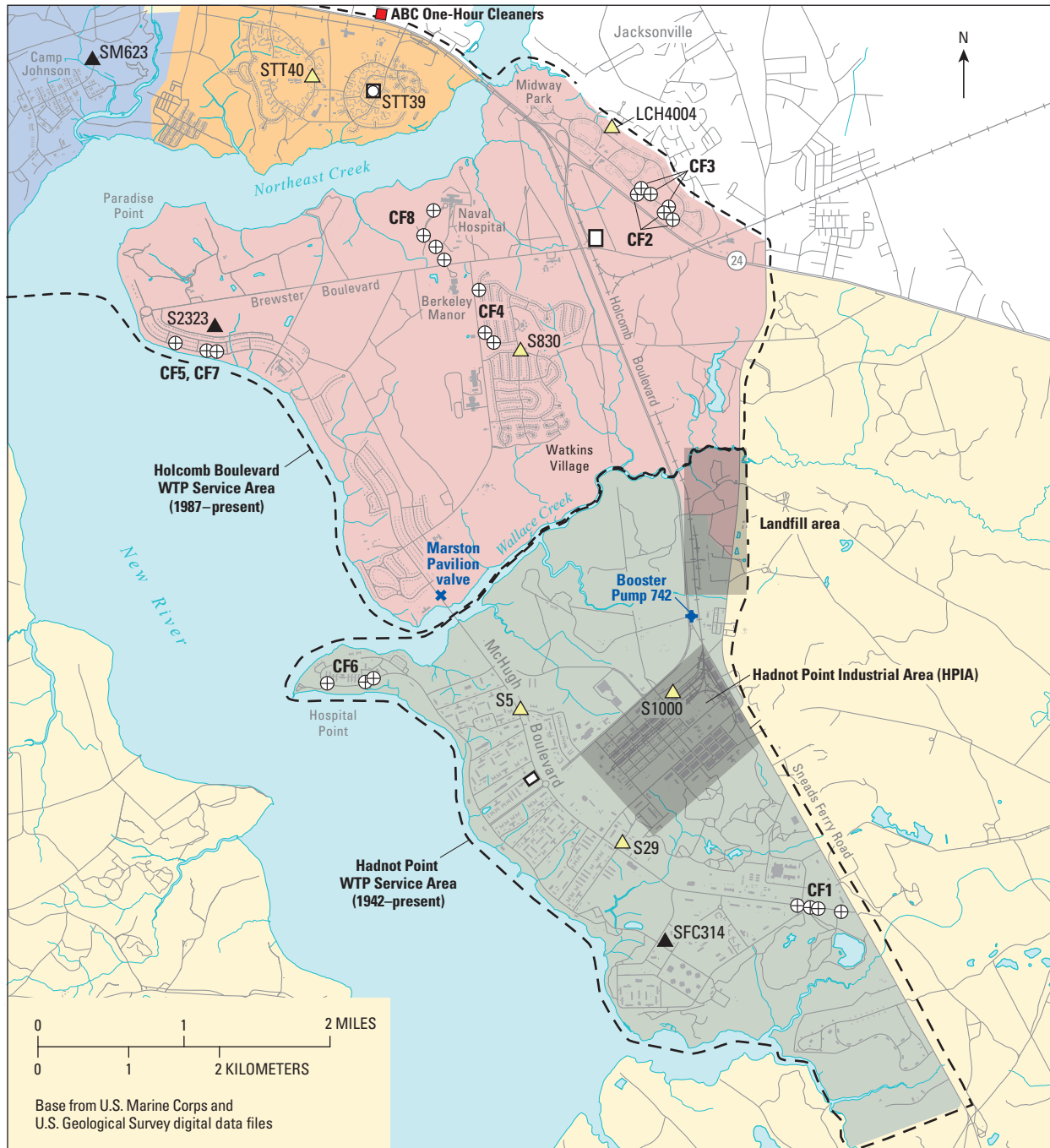

Base from U.S. Marine Corps and U.S. Geological Survey digital data files

EXPLANATION

- Historical water-supply areas of Camp Lejeune Military Reservation**
- Montford Point
 - Tarawa Terrace
 - Other areas of Camp Lejeune Military Reservation
 - Holcomb Boulevard
 - Hadnot Point

- Water treatment plant— Name and length of operation**
- Hadnot Point: 1942–present
 - Holcomb Boulevard: June 1972–present
 - Tarawa Terrace: 1952–1987
- CF6 ⊕ Pressure and flow device location and group number**

- Storage tank and identifier**
- ▲ SFC314 Elevated—Controlling
 - △ S5 Elevated
 - STT39 Ground—Finished water

Figure S8.5. Location of pressure loggers and flow devices used to conduct C-factor tests for the Hadnot Point and Holcomb Boulevard water treatment plant service areas, Hadnot Point–Holcomb Boulevard study area, U.S. Marine Corps Base Camp Lejeune, North Carolina, August 25, 2004.



Figure S8.6. C-factor test hydrant equipped with (A) WIKA 4-inch, 0–100 psi, manual reading gauge, and (B) Dixon PR300, 0–300 psi, pressure data logger gauge (recording time set to 1-minute intervals on data logger), Hadnot Point–Holcomb Boulevard study area, U.S. Marine Corps Base Camp Lejeune, North Carolina, August 25, 2004. [psi, pounds per square inch]



Figure S8.7. (A) Flowing hydrant with Plant PRO HFD hydrant flow tester (pitot tube with wire-cage diffuser), and (B) debris found in diffuser after conducting C-factor test, Hadnot Point–Holcomb Boulevard study area, U.S. Marine Corps Base Camp Lejeune, North Carolina, August 25, 2004.

Table S8.6. Hazen-Williams C-factor values for the Hadnot Point and Holcomb Boulevard water treatment plant service areas, Hadnot Point–Holcomb Boulevard study area, U.S. Marine Corps Base Camp Lejeune, North Carolina, August 25–27, 2004.

[PVC, polyvinyl chloride]

| Test identifier ¹ | Pipe length, in feet | Nominal diameter, in inches | Flow, in gallons per minute | Pipe material | Computed C-factor | Reference C-factor ² |
|------------------------------|----------------------|-----------------------------|-----------------------------|-----------------|-------------------|---------------------------------|
| CF-H01 | 1,623 | 12 | 804 | PVC | 145 | 147 |
| CF-H02 | 1,190 | 8 | 590 | Cast iron | 65 | 97–102 |
| CF-H03 | 1,202 | 6 | 564 | Cast iron | 109 | 97 |
| CF-H04 | 2,080 | 8 | 626 | Cast iron | 80 | 97–102 |
| CF-H05 | 700 | 8 | 947 | Cast iron | 94 | 97–102 |
| CF-H06 | 1,435 | 10 | 835 | PVC | 120 | 147 |
| CF-H07 | 1,180 | 8 | 835 | Cast iron | 108 | 97–102 |
| CF-H08 | 1,670 | 10 | 920 | Asbestos cement | 190 | 150 |

¹Test identifiers are shown in Figure S8.5

²Data from Walski et al. (2003)

Fire-Flow Tests¹⁴

Fire-flow tests were conducted at eight locations (Figure S8.8) characterized by three different pipe materials (cast iron, PVC, and asbestos cement). For the test pipelines: (1) diameters ranged from 4 in. to 12 in., (2) lengths ranged from 236 ft to 1,620 ft, and (3) flows ranged from 773 gpm to 1,120 gpm. Data from fire-flow tests are frequently used as part of the hydraulic model calibration effort. The concept is quite straightforward. A hydrant is opened and flowed so as to increase flows in the distribution system in the vicinity of the hydrant. Because friction losses increase exponentially—to the power 2 with the Darcy-Weisbach friction equation and to the power 1.85 in the Hazen-Williams equation (Walski 1992)—the higher flows can result in a significant lowering of the hydraulic grade line (HGL).

In the simplest configuration, a single hydrant is flowed, and pressure is measured at another single hydrant. If the single hydrant does not sufficiently stress the system (i.e., produce sufficient headloss), additional hydrants can be flowed at the same time, thus further lowering the HGL. Also, pressure and HGL measurements can be made at additional hydrants in order to provide more data for use in the calibration process. Typically, however, as more hydrants are flowed and measurements are made at additional hydrants, more personnel are required or the duration of the test must be lengthened so that crews can travel between hydrants.

An alternative approach was used at USMCB Camp Lejeune to collect more data and to improve the labor efficiency. Continuous recording pressure gauges (Dixon PR300, Figure S8.6B) were installed at up to six hydrants in the area being tested (Figure S8.8). These gauges were set to record a pressure measurement at 1-minute intervals. Additionally, pitot gauges were installed on two hydrants that were designated as hydrants to be flowed. One of the pitot gauges was integrated with a diffuser and cage to both diffuse the flow from the hydrant and to trap any solids to prevent damage from the flow (Figure S8.7B). The other pitot gauge was a standard gauge attached to the hydrant (Figure S8.9). The following equations were used to convert pressure readings on the two pitot gauges to flow:

Plant PRO HFD pitot gauge with diffuser (Figure S8.7A):

$$Q = 0.845 \times 167 \times (P)^{1/2}, \quad (\text{S8.1})$$

where

$$\begin{aligned} Q &= \text{flow, in gallons per minute, and} \\ P &= \text{pressure, in pounds per square inch.} \end{aligned}$$

¹⁴ This section was written by Walter M. Grayman, Consulting Engineer. Because an innovative approach was used to conduct the fire-flow tests (with respect to methods published in literature), a thorough description of the procedures used to conduct these tests is being presented.

Standard pitot gauge (Figure S8.9):

$$Q = 167 \times (P)^{1/2}. \quad (\text{S8.2})$$

Typically, up to five different situations were then studied—each for a period of 3 to 4 minutes:

1. Static conditions (no hydrant flowed),
2. Hydrant number 1 flowed,
3. Hydrant numbers 1 and 2 flowed simultaneously,
4. Hydrant number 2 flowed, and
5. Static conditions (no hydrant flowed).

With this setup, the total time to conduct this compound fire-flow test was less than an hour including (1) installation of equipment (pitot gauges and pressure gauges), (2) running the test under the five conditions noted above, and (3) disassembling the equipment. This procedure can be safely and quickly performed by a crew of two people. Typically one person is stationed at each of the flowing hydrants. Further expansion is possible if additional pitot gauges or pressure gauges are available (Grayman et al. 2006).

Fire-flow tests were performed at eight sites (Figure S8.8). Slight variations were made at some sites in terms of the number of pressure gauges that were installed or in the protocol. The results were generally quite favorable; however, in a few cases, some of the pressure gauges did not operate correctly or the system was not sufficiently stressed to provide good calibration information. Out of the eight tests, four resulted in sufficient lowering of the HGL, and data from those four tests were deemed useful for model calibration. The other four tests resulted in pressure drops that were not sufficient for good model calibration. Three separate test cases that cover the various test protocols and results are described below.

Case 1: In this case, four pressure gauges and two pitot gauges were installed as shown in Figure S8.10. The five separate operating situations previously listed were followed with the resulting flows and pressures shown in Figure S8.10. As shown, significant reductions in pressure were recorded (a pressure drop of as much as 26 psi) with greater reductions occurring when both hydrants were being flowed. These pressure reductions exceed the minimum reduction of 10 psi that Walski et al. (2003) recommend for effective model calibration. In all cases, the static pressures measured at the start and end of the tests are within 0.5 psi indicating good consistency in the measurements. It should be noted that because the USMCB Camp Lejeune area has a nearly flat terrain, comparison of pressures provides similar results as comparison of hydraulic grades.

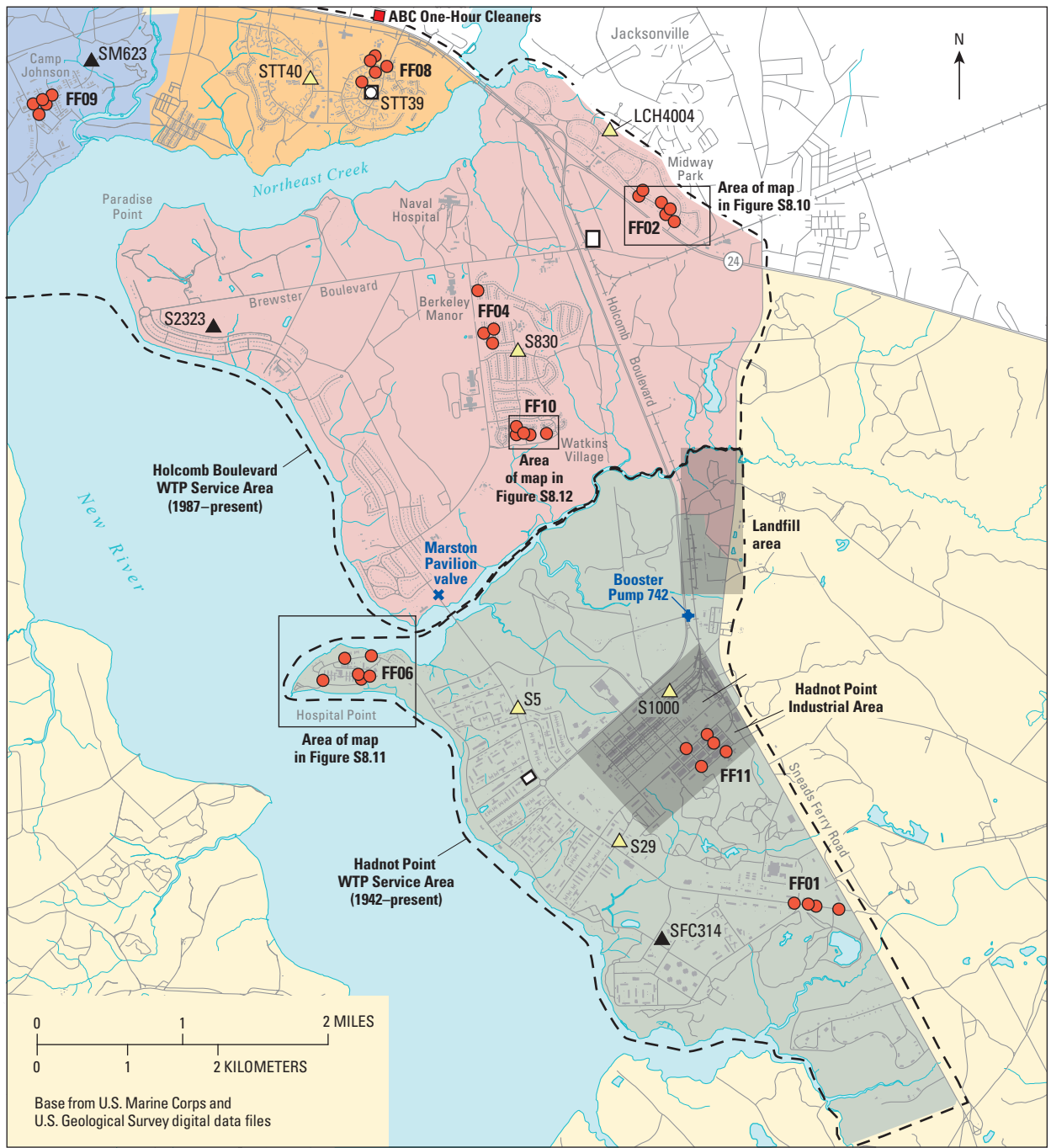

EXPLANATION

| | | |
|---|---|---|
| <p>Historical water-supply areas of Camp Lejeune Military Reservation</p> <ul style="list-style-type: none"> Montford Point Tarawa Terrace Other areas of Camp Lejeune Military Reservation Holcomb Boulevard Hadnot Point | <p> Water treatment plant— Name and length of operation Hadnot Point: 1942–present Holcomb Boulevard: June 1972–present Tarawa Terrace: 1952–1987</p> | <p>Storage tank and identifier</p> <ul style="list-style-type: none"> ▲ SFC314 Elevated—Controlling S5 Elevated STT39 Ground—Finished water |
| | <p> FF01 Fire-flow test location and group number</p> | |

Figure S8.8. Location of pressure loggers and flow devices used to conduct fire-flow tests for the Hadnot Point and Holcomb Boulevard water treatment plant service areas, Hadnot Point–Holcomb Boulevard and Tarawa Terrace study areas, U.S. Marine Corps Base Camp Lejeune, North Carolina, August 25–27, 2004.



Figure S8.9. Flowing hydrant with standard pitot gauge attached to hydrant used to conduct fire-flow test (gauge reads pressure and flow), Hadnot Point–Holcomb Boulevard study area, U.S. Marine Corps Base Camp Lejeune, North Carolina, August 25–27, 2004.

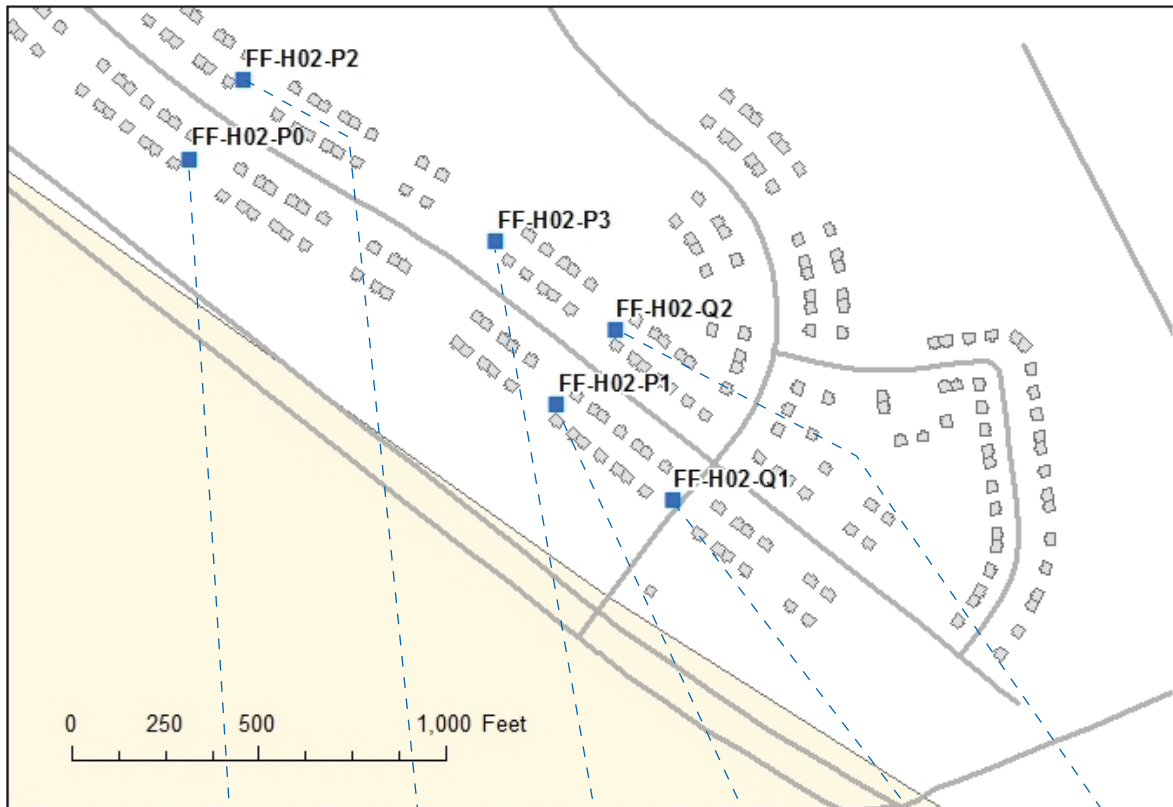

| EXPLANATION | FF-H02-P0 | FF-H02-P2 | FF-H02-P3 | FF-H02-P1 | FF-H02-Q1 | FF-H02-Q2 |
|---------------------|-----------|-----------|-----------|-----------|-----------|-----------|
| Station number | | | | | | |
| units | | | | | | |
| Static case | 53.1 | 56.2 | 52.6 | 50.7 | 0 | 0 |
| Hydrant 1 flowed | 41.4 | 46.8 | 42.9 | 37.3 | 773 | 0 |
| Hydrants 1+2 flowed | 29.7 | 36.5 | 32.7 | 24.5 | 631 | 579 |
| Hydrant 2 flowed | 43.9 | 48.1 | 44.1 | 40.7 | 0 | 747 |
| Static case | 53.5 | 56.5 | 52.9 | 51.2 | 0 | 0 |

Figure S8.10. Fire-flow test, Case 1: Midway Park area serviced by Holcomb Boulevard water treatment plant, Hadnot Point–Holcomb Boulevard study area, U.S. Marine Corps Base Camp Lejeune, North Carolina, August 25–27, 2004. See Figure S8.8 for location. [gpm, gallons per minute; psi, pounds per square inch]

Case 2: In this test case, a looped system was tested with a pipe bisecting the loop (Figure S8.11). The normal protocol was modified slightly in this case to determine the effect of the bisector on system pressures. Specifically, the test was conducted with the isolation valve on the bisector pipe either open or closed. Four pressure gauges and the two pitot gauges were installed, and the following four situations were run (Figure S8.11):

1. Static conditions with the valve open,
2. Hydrant 1 flowing with the valve open,
3. Hydrants 1 and 2 flowing with the valve open, and
4. Hydrants 1 and 2 flowing with the valve closed.

The results of the test, shown in Figure S8.11, indicate that pressure drops of up to 15 psi were observed and that the closed valve had no effect on the pressures.

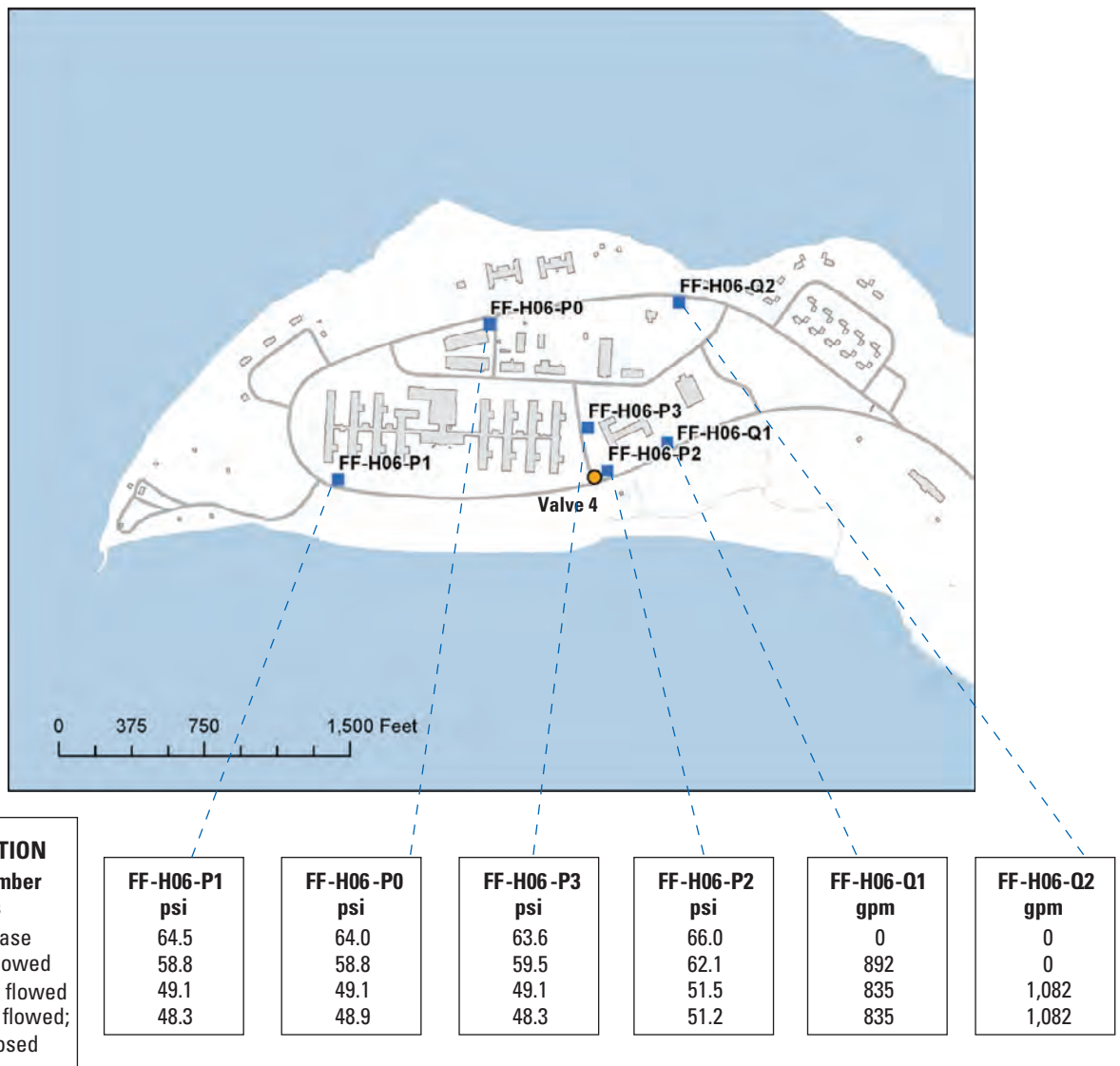

Figure S8.11. Fire-flow test, Case 2: Hospital Point area serviced by Hadnot Point water treatment plant, Hadnot Point–Holcomb Boulevard study area, U.S. Marine Corps Base Camp Lejeune, North Carolina, August 25–27, 2004. See Figure S8.8 for location. [gpm, gallons per minute; psi, pounds per square inch]

Case 3: In this case, only three of the pressure gauges that were installed worked correctly. The locations of these pressure gauges and the two pitot gauges are shown in Figure S8.12. The pressure results indicate that the maximum pressure reduction that was observed was only 4.1 psi. This

is well below the guideline of Walski et al. (2003), so this test was assumed to be of little use for model calibration. In order to make the test more effective, additional hydrants would need to be flowed to obtain a significant pressure drop.

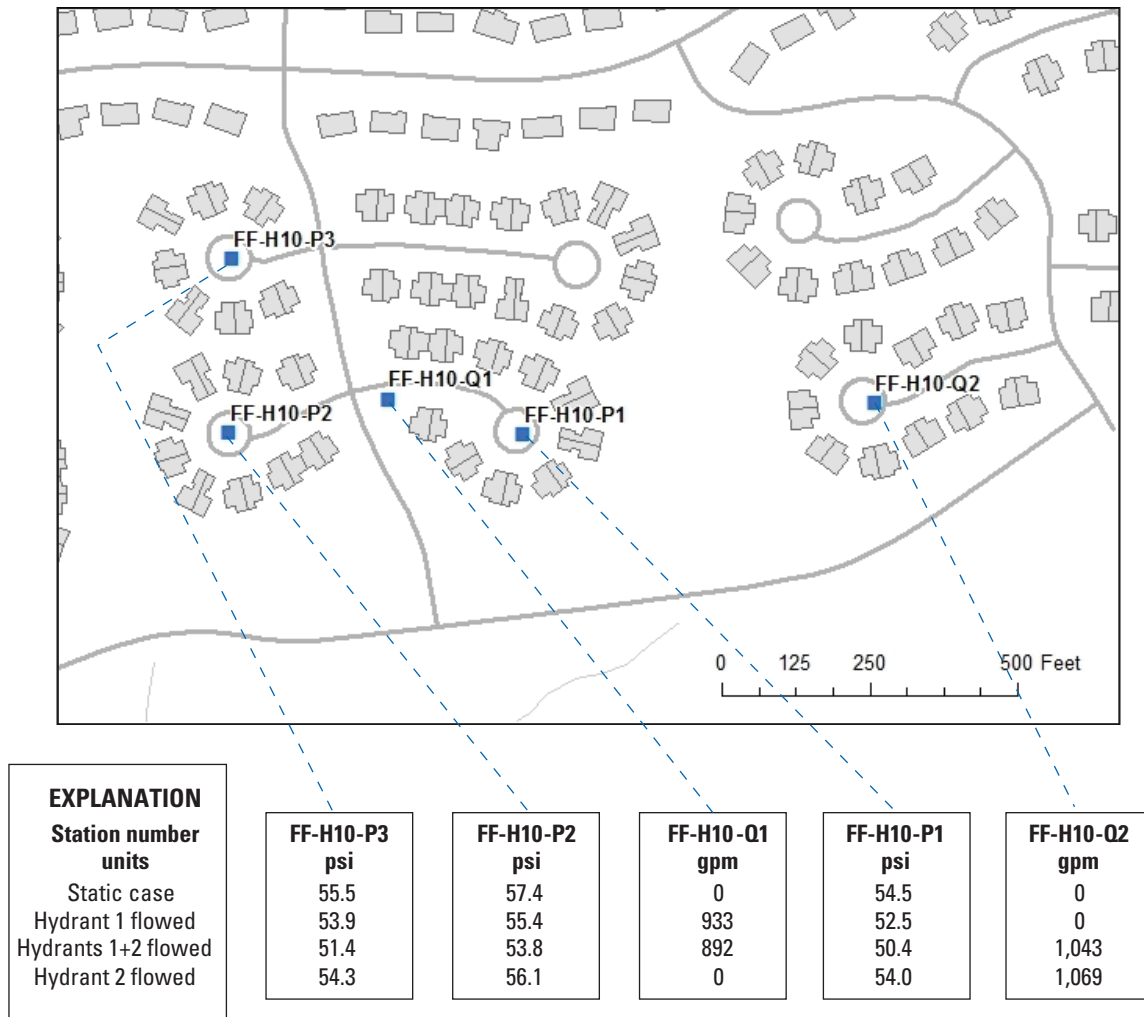

Figure S8.12. Fire-flow test, Case 3: Watkins Village area serviced by Holcomb Boulevard water treatment plant, Hadnot Point–Holcomb Boulevard study area, U.S. Marine Corps Base Camp Lejeune, North Carolina, August 25–27, 2004. See Figure S8.8 for location. [gpm, gallons per minute; psi, pounds per square inch]

Holcomb Boulevard Water Treatment Plant Service Area, September—October 2004

A field test conducted during September 22–October 12, 2004, consisted of monitoring fluoride dilution and re-injection in the HBWTP area (including the Tarawa Terrace and Camp Johnson/Montford Point areas, Figure S8.13). To monitor and record system fluoride concentrations, nine hydrants were equipped with the Horiba W-23XD continuous recording, dual-probe ion detector data loggers (Figure S8.14).¹⁵ In addition to continuously recording fluoride concentration data, grab samples were collected for QA/QC purposes. Samples were analyzed at the HBWTP water-quality laboratory by USMCB water utility staff and also shipped to the Federal Occupational Health (FOH) laboratory in Chicago, Illinois, for analyses (<http://www.foh.dhhs.gov>).

The purposes of this test were to:

1. Estimate travel time between points in the Holcomb Boulevard and Tarawa Terrace water-distribution systems by shutting off and then restarting the NaF treatment at the HBWTP,
2. Record the fill and draw characteristics at the controlling elevated storage tanks (S2323 and SM623, Figure S8.13) in the HBWTP service area,
3. Record the sequence of when water-distribution system fluoridated water was filling the storage tanks and when storage tank fluoridated water was being supplied to the water-distribution system, and
4. Conduct QA/QC tests on the fluoride sensors contained in the continuous recording dual-probe Horiba W-23XD data loggers (Figure S8.14).

Nine monitoring locations were used. Five locations were in the Holcomb Boulevard water-distribution system area, and four locations were in the Tarawa Terrace water-distribution system area (Figure S8.13). All monitoring locations were equipped with the Horiba W-23XD data logger (Figure S8.14). Monitoring locations included the main transmission line from the HBWTP to the water-distribution system (F01, Figure S8.13), the Tarawa Terrace finished-water reservoir (F02), two controlling elevated storage tanks (F08 and F09), and five hydrants located throughout the Holcomb Boulevard and Tarawa Terrace housing areas (F03, F04, F05, F06, and F07).

¹⁵ Owing to brevity, this equipment is referred to as fluoride data logger or Horiba W-23XD data logger in this supplement.

Sodium Fluoride (NaF) Shutoff and Re-Injection

The NaF at the HBWTP was shut off at 1600 hours on September 22, 2004. A background concentration of about 0.2 mg/L in the water-distribution system was achieved by September 28, 2004. At 1200 hours on September 29, the NaF was turned back on at the HBWTP, and the test continued until loggers were removed and data downloaded on October 12 (e.g., Figure S8.15). In addition to collecting fluoride data using the continuous recording data loggers, 250-mL grab samples were collected to conduct split-grab-sample analyses for QA/QC purposes. Nineteen rounds of water samples were collected at each monitoring location during the test. For each round, the HBWTP water-quality laboratory analyzed 25 mL of the grab-sample water, and the remaining 225 mL of grab-sample water were sent to the FOH laboratory (Chicago, Illinois) for analysis.

Holcomb Boulevard Water Treatment Plant Service Area Test Results

Logger F01 (Figure S8.15) was located on the main transmission line going from the HBWTP to the water-distribution system (Figure S8.13). Logger F01 recorded water-quality data that represent a source condition for fluoride in the HBWTP service area. Agreement is very good between the continuous recording data logger (solid line) and QA/QC grab samples analyzed at the HBWTP (triangles) and the FOH water-quality laboratories (diamonds). This logger was equipped with two sensors (identified as ION2 and ION3 in Figure S8.15).¹⁶ Although both sensors track closely with one another and with the grab-sample data for most of the test, ION3 begins to show significant drift from ION2 and from the grab-sample data after about October 2, 2004. ION3 also exhibits “spikes” after October 3, 2004.

Logger F02 (Figure S8.15) was attached to the main transmission line distributing finished water from the Tarawa Terrace ground storage tank (Figure S8.13). The decrease and increase in fluoride concentration are significantly attenuated compared with concentrations recorded by source logger F01 because of the large volume of water that is contained in the storage tank. Logger F02 was equipped with two fluoride sensors that were used for QA/QC. Comparing data from the two fluoride sensors (ION2 and ION3, Figure S8.15) with grab-sample data indicates consistent results. After about 14 days, however, logger data appear to show some “drift” in the logger calibration with respect to the grab-sample data.

¹⁶ In this supplement, water-quality data logger sensors are identified as ION1, ION2, or ION3.

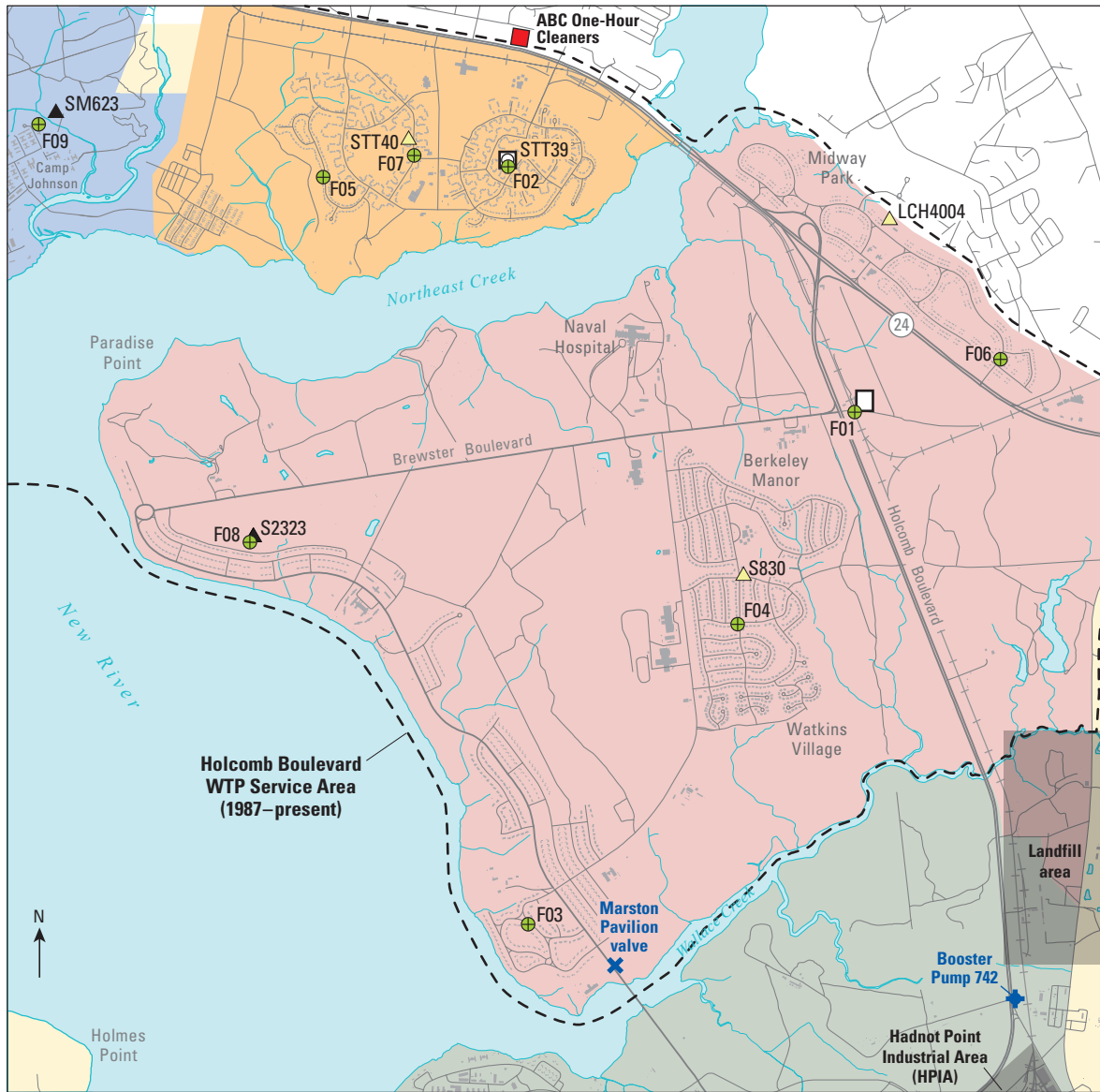

Base from U.S. Marine Corps and U.S. Geological Survey digital data files

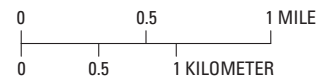

EXPLANATION

- | | | |
|--|--|--|
| <p>Historical water-supply areas of Camp Lejeune Military Reservation</p> <ul style="list-style-type: none"> Montford Point Tarawa Terrace Holcomb Boulevard Hadnot Point | <p> Other areas of Camp Lejeune Military Reservation</p> <p> F03 ATSDR fluoride logger and identifier</p> <p> Water treatment plant— Name and length of operation Holcomb Boulevard: June 1972–present Tarawa Terrace: 1952–1987</p> | <p>Storage tank and identifier</p> <ul style="list-style-type: none"> S2323 Elevated—Controlling S830 Elevated STT39 Ground—Finished water |
|--|--|--|

Figure S8.13. Location of fluoride data loggers used for conducting a tracer test of the present-day (2004) Holcomb Boulevard water treatment plant service area, Hadnot Point–Holcomb Boulevard and Tarawa Terrace study areas, U.S. Marine Corps Base Camp Lejeune, North Carolina, September 22–October 12, 2004.



Figure S8.14. Selected field-test equipment: Horiba W-23XD continuous recording, dual-probe ion detector data logger inside flow cell, Hadnot Point–Holcomb Boulevard study area, U.S. Marine Corps Base Camp Lejeune, North Carolina, 2004.

Loggers F03 and F04 (Figure S8.16) were attached to hydrants located in family housing areas served by the Holcomb Boulevard water-distribution system (Figure S8.13). Data from both loggers are in good agreement with grab-sample data (Figure S8.16). However, data from logger F04 exhibit “drift” with respect to grab-sample data after about 10 days. Data from both loggers also show nearly identical fluctuations as data from source logger F01, indicating that there is probably little mixing or travel through complex paths within the water-distribution system from the HBWTP to these housing areas.

Logger F05 (Figure S8.17) is located in the Tarawa Terrace family housing area and is served by the Tarawa Terrace water-distribution system (Figure S8.13). Logger F06 (Figure S8.17) is located in the Midway Park housing area and is served by the Holcomb Boulevard water-distribution system (Figure S8.13). Data from logger F06 exhibit very little attenuation when compared with the data from source logger F01 (compare Figures S8.17 and S8.15), thus indicating very little mixing of the fluoride as it travels from the source (HBWTP) through Midway Park to the location of logger F06. Conversely, data from logger F05 show significant attenuation when compared with data from source logger F01. Two reasons probably account for this apparent significant attenuation:

1. The logger is located in the Tarawa Terrace water-distribution system and receives water from the Tarawa Terrace finished-water ground storage tank (Figure S8.13). Thus, the finished-water ground storage tank probably accounts for a significant amount of the fluoride attenuation. In fact, the ION2 data from logger F05 (Figure S8.17) show repeated cycles of storage tank fill and drain action.
2. The Tarawa Terrace housing area is characterized by significant looping and meandering pipelines. This is most likely causing more mixing and attenuation of the fluoride when compared with data from logger F06, which is located in the Midway Park housing area.

The data recorded for ION3 in logger F05 (Figure S8.17) show a complete departure from ION2 data and grab-sample data. Thus, this fluoride sensor was most likely malfunctioning from the start of the test and was not useful for recording representative water-quality data. The ION2 and ION3 data from logger F06 track nicely with each other and with grab-sample data until about 10 days after the start of the test, whereupon they begin to exhibit drift when compared with grab-sample data and the 1.0-mg/L fluoride concentration that is typically maintained in the USMCB Camp Lejeune water-distribution systems.

Data from logger F07 for ION2 and ION3 (Figure S8.18) indicate sensor malfunction with respect to grab-sample data and the 1.0-mg/L fluoride concentration that is typically maintained in the USMCB water-distribution systems. ION2 data, however, somewhat track with grab-sample data, exhibiting fluoride dilution during the fluoride shutoff time and increasing concentration when the fluoride is re-injected at the HBWTP. ION2 data also exhibit the cyclic fill and draw, which are most likely caused by the Tarawa Terrace finished-water ground storage tank.

Loggers F08 (Figure S8.18) and F09 (Figure S8.19) were used to monitor elevated storage tanks S2323 and SM623—controlling tanks—in the Holcomb Boulevard and Tarawa Terrace water-distribution areas, respectively (Figure S8.13). The water levels in these controlling tanks are allowed to fluctuate as demand varies (see previous discussion in the Water-Distribution Systems section). The recorded data for loggers F08 and F09 clearly show draw and fill cycles of the tanks. The data from logger F08 indicate that the fluoride concentration in the Holcomb Boulevard water-distribution system reached a near background level of about 0.2 mg/L on September 28. Even so, the elevated storage tank still contains water with a fluoride concentration of about 0.8 mg/L. These data are recorded using the continuous recording water-quality monitoring equipment and would have been missed if one were to rely solely on grab-sample data to conduct the tracer test. Data from logger F09 clearly show a more attenuated pattern than the data from logger F08, most likely because elevated storage tank SM623 and logger F09 were located near the furthest extremity of the Tarawa Terrace water-distribution system (Figure S8.13).

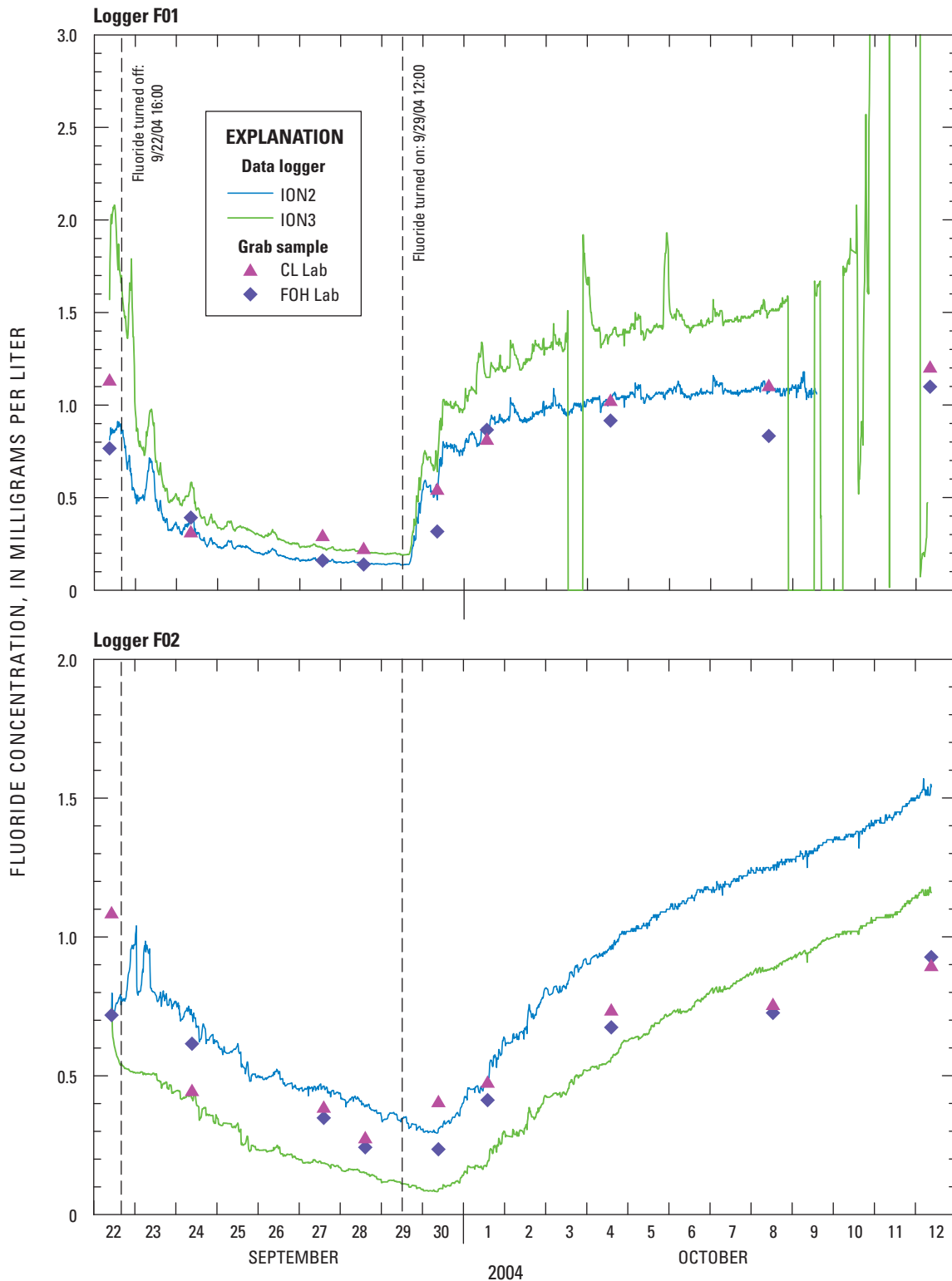

Figure S8.15. Fluoride concentration data for loggers F01 and F02, 15-minute intervals, Holcomb Boulevard water treatment plant service area, Hadnot Point–Holcomb Boulevard study area, U.S. Marine Corps Base Camp Lejeune, North Carolina, September 22–October 12, 2004. [ION2 and ION3, data logger; CL Lab, Holcomb Boulevard water treatment plant water-quality laboratory; FOH Lab, Federal Occupational Health laboratory, Chicago, Illinois]

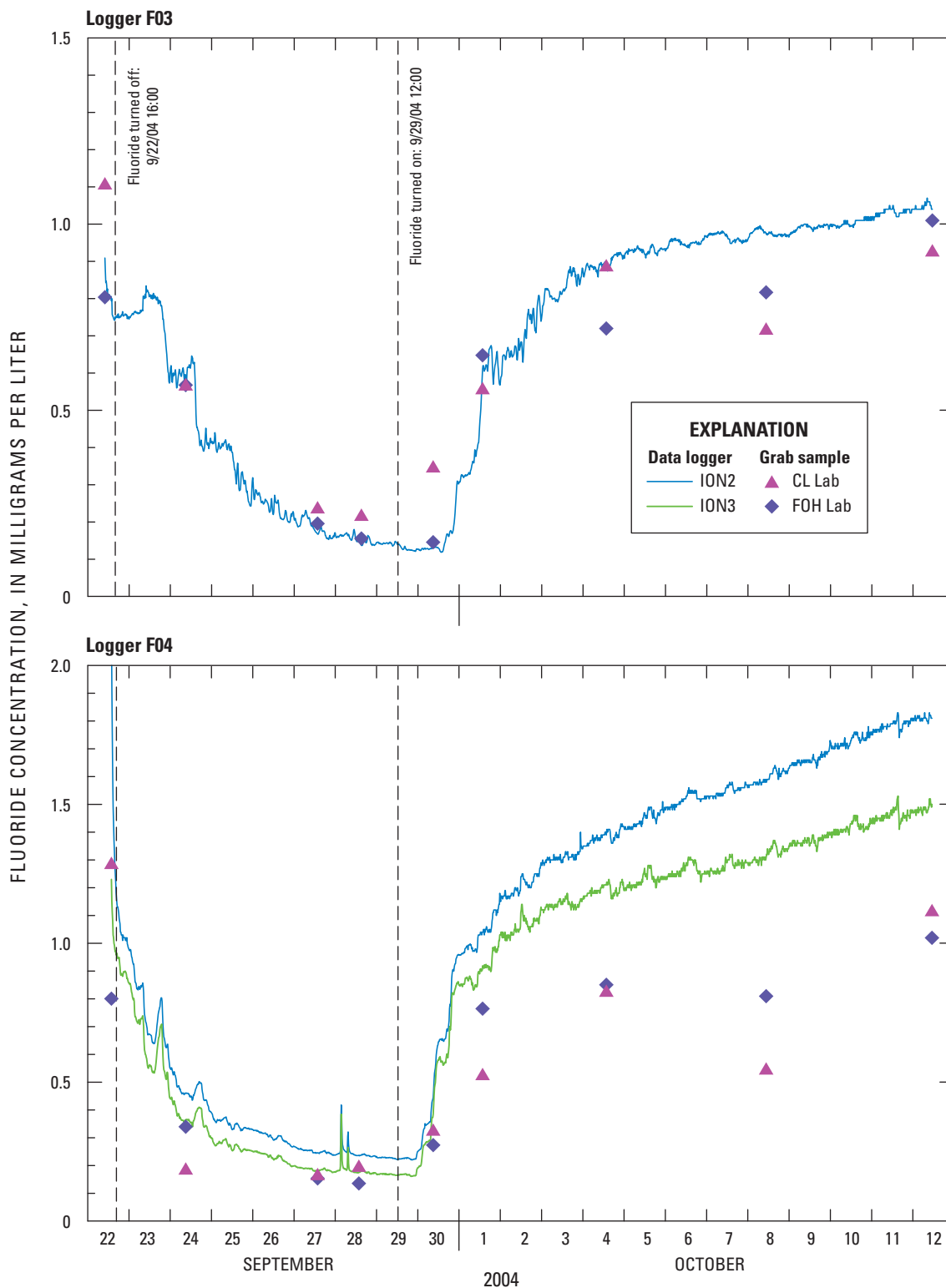

Figure S8.16. Fluoride concentration data for loggers F03 and F04, 15-minute intervals, Holcomb Boulevard water treatment plant service area, Hadnot Point–Holcomb Boulevard study area, U.S. Marine Corps Base Camp Lejeune, North Carolina, September 22–October 12, 2004. [ION2 and ION3, data logger; CL Lab, Holcomb Boulevard water treatment plant water-quality laboratory; FOH Lab, Federal Occupational Health laboratory, Chicago, Illinois]

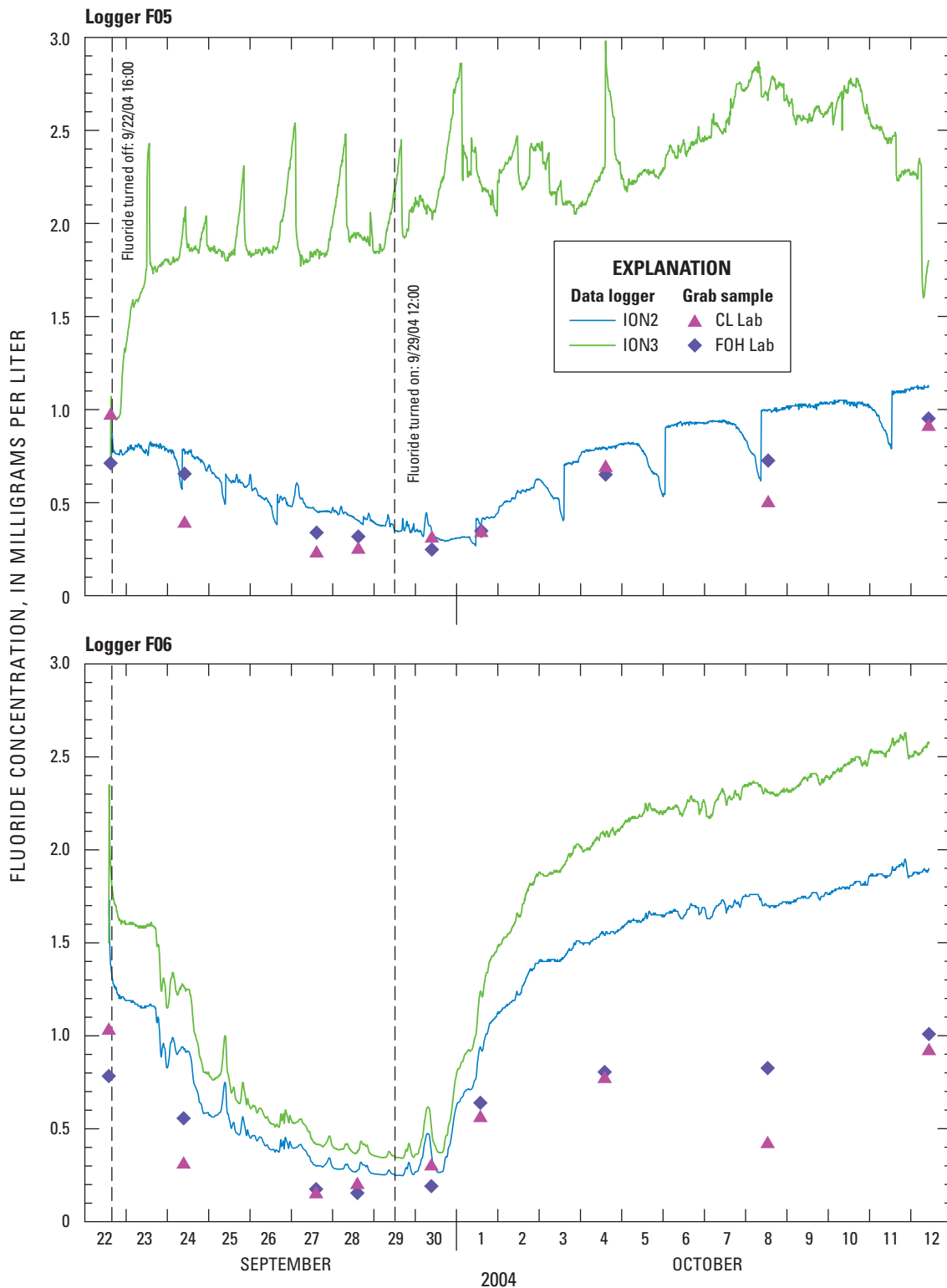
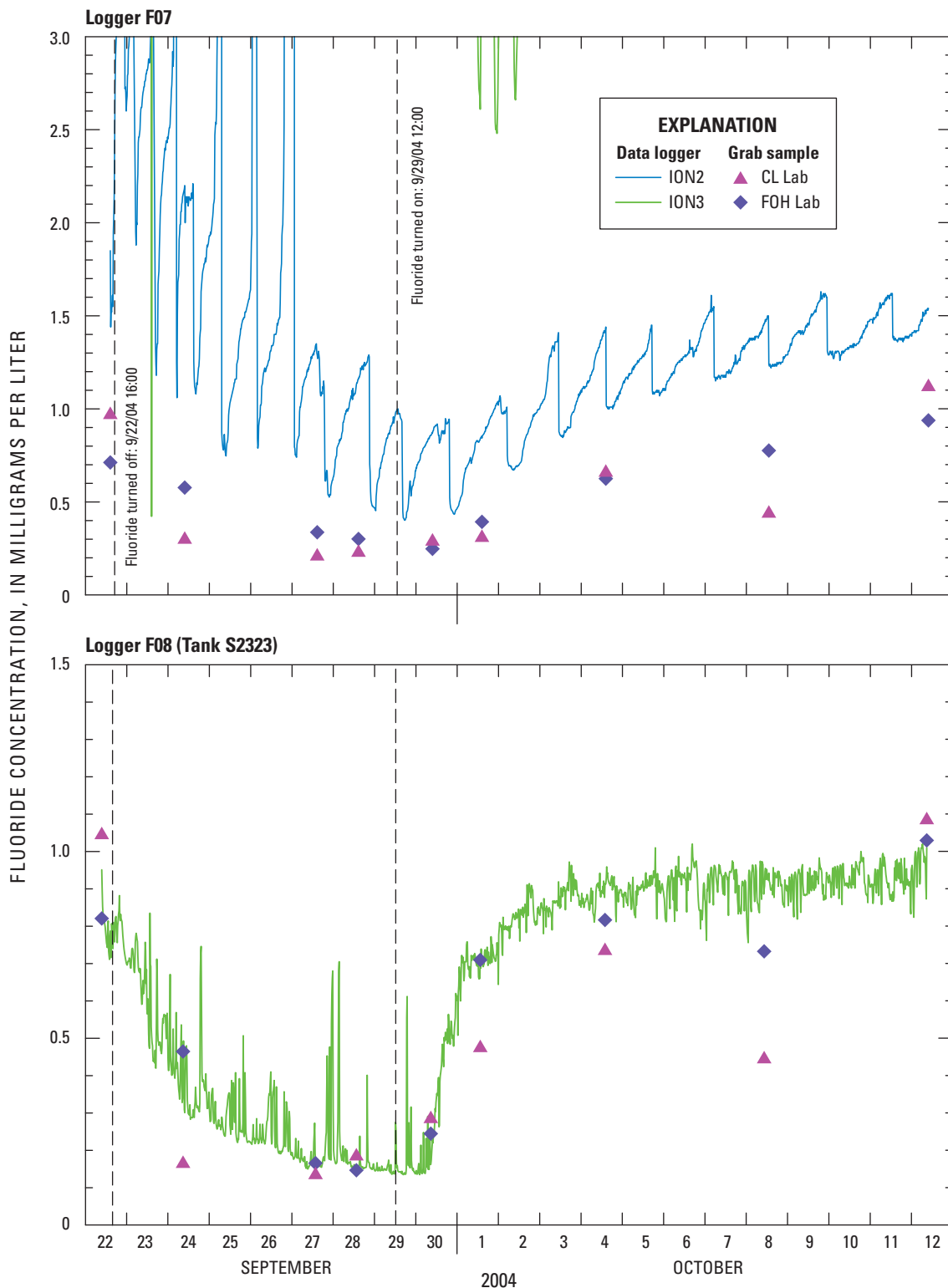

Figure S8.17. Fluoride concentration data for loggers F05 and F06, 15-minute intervals, Holcomb Boulevard water treatment plant service area, Hadnot Point–Holcomb Boulevard study area, U.S. Marine Corps Base Camp Lejeune, North Carolina, September 22–October 12, 2004. [ION2 and ION3, data logger; CL Lab, Holcomb Boulevard water treatment plant water-quality laboratory; FOH Lab, Federal Occupational Health laboratory, Chicago, Illinois]



Figures S8.18. Fluoride concentration data for loggers F07 and F08, 15-minute intervals, Holcomb Boulevard water treatment plant service area, Hadnot Point–Holcomb Boulevard study area, U.S. Marine Corps Base Camp Lejeune, North Carolina, September 22–October 12, 2004. [ION2 and ION3, data logger; CL Lab, Holcomb Boulevard water treatment plant water-quality laboratory; FOH Lab, Federal Occupational Health laboratory, Chicago, Illinois]

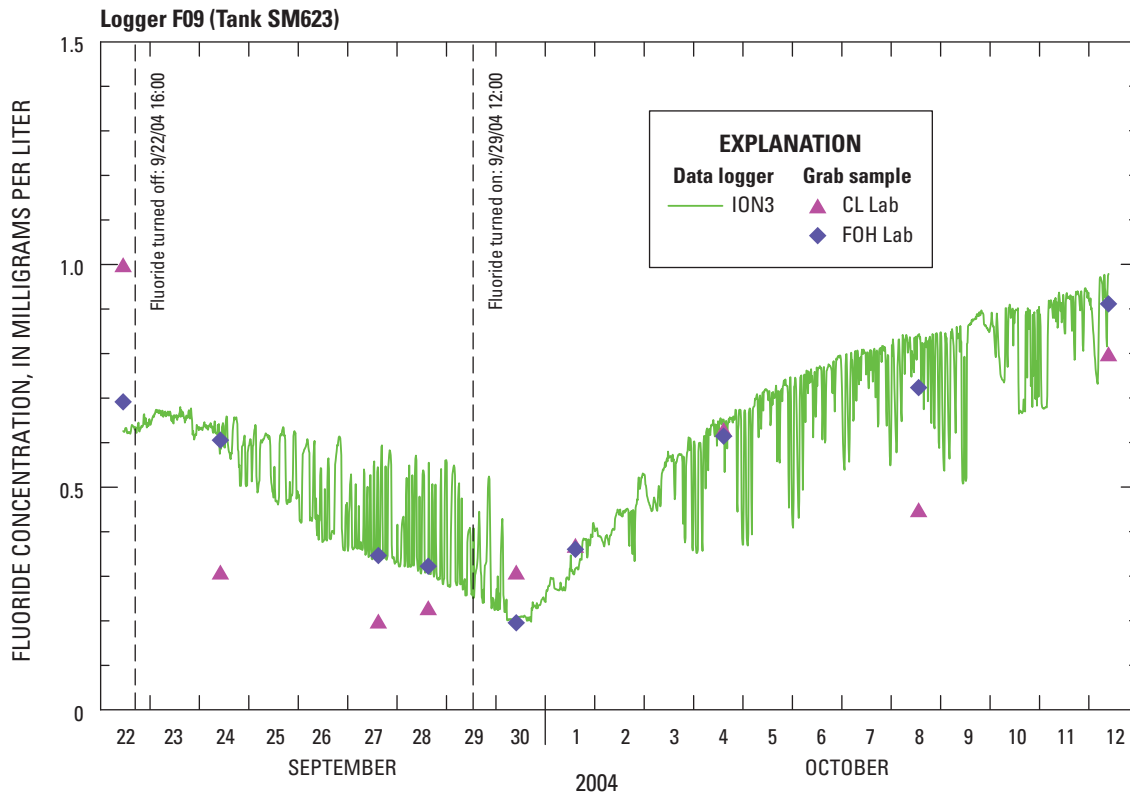

Figure S8.19. Fluoride concentration data for logger F09, 15-minute intervals, Holcomb Boulevard water treatment plant service area, Hadnot Point–Holcomb Boulevard study area, U.S. Marine Corps Base Camp Lejeune, North Carolina, September 22–October 12, 2004. [ION3, data logger; CL Lab, Holcomb Boulevard water treatment plant water-quality laboratory; FOH Lab, Federal Occupational Health laboratory, Chicago, Illinois]

Summary of Field Testing and Results

Data from all the field tests described in this section were analyzed and used to assist with model calibration. The hydraulic and water-quality tests have yielded data that investigators can use to assist with interpreting hydraulic characteristics and water-quality dynamics of the water-distribution systems serving family housing areas of USMCB Camp Lejeune. The C-factor data listed in Table S8.6 and the fire-flow test data (Figures S8.10–S8.12) partially represent the hydraulic characteristics of the water-distribution systems. Figures S8.15–S8.17 show arrival-time data for the fluoride tracer tests, and Figures S8.18 and S8.19 show fluoride

concentration data characterizing the fill and draw action of elevated storage tanks. These water-quality data were used to gain insight into residence and travel times characteristic of the water-distribution system dynamics. Thus, conducting field tests at USMCB Camp Lejeune yielded both hydraulic and water-quality parameter data that are essential to understanding system parameter value ranges and variability. The data also are essential for developing calibrated hydraulic and water-quality models of 2004 conditions that characterized the water-distribution systems at USMCB Camp Lejeune. The water-distribution system models can also be used to assist the ATSDR health studies.

Estimating Water Consumption— Water Conservation Analysis Methodology

In the Water Conservation Analysis (WCA) report (ECG, Inc. 1999), water consumption for the HBWTP service area (Figure S8.3) was estimated using 1998 USMCB Camp Lejeune information and data. The information presented in this section updates information and data from the WCA (ECG, Inc. 1999) estimates with information and data from 2004.¹⁷ As previously noted, with the exception of power plants, water consumption is not metered at USMCB Camp Lejeune. Using the WCA methodology, water consumption is defined herein as the maximum potential total consumption derived from manufacturers' suggested guidelines for water-consuming devices such as toilets, showers, and sinks.

Estimating Water Consumption

From 1998 to 2004, the total population living in family housing served by the HBWTP (Figure S8.3) decreased from 13,806 to 11,491, and the number of occupied houses decreased from 3,768 to 3,241. The number of people living in bachelor housing increased from 1,863 in 1998 to 1,871 in 2004. The working population in 2004 was assumed to be the same as in 1998 due to lack of information for 2004. Because of these population changes, the estimated total consumption for the HBWTP service area decreased from 1.33 MGD during 1998 to 1.16 MGD during 2004 for family housing, bachelor housing, mess halls, and other facilities (Table S8.7).

¹⁷ Information and data pertaining to 2004 were provided to ATSDR following telephonic requests and oral discussions between ATSDR staff and USMCB Camp Lejeune Environmental Management Division and water utility staff.

Table S8.7. Holcomb Boulevard water treatment plant service area water-use inventory, Hadnot Point–Holcomb Boulevard study area, U.S. Marine Corps Base Camp Lejeune, North Carolina, 1998 and 2004.

[WTP, water treatment plant]

| Water-use category | Consumption, in gallons per day | |
|---|---------------------------------|------------------------------|
| | 1998 | 2004 |
| Family housing | 843,103 | 696,294 |
| Bachelor housing | 122,213 | 122,738 |
| Offices and work areas | 25,529 | 25,529 |
| Mess halls | 13,772 | 14,502 |
| Cooling systems | 7,000 | 7,000 |
| Heating plant | 14,000 | 14,000 |
| Major tenants | 111,797 | 111,797 |
| Irrigation | 190,496 | 163,853 |
| Total estimated consumption | 1,327,910 | 1,155,713 |
| Total treated water delivered from WTP | ¹1,980,000 | ²1,460,255 |
| Unaccounted-for water | 652,090 | 304,542 |

¹Average water production in 1998 (Source: ECG, Inc. 1999)

²Average water production in 2004 (Source: D.E. Hill, Camp Lejeune Water Department, electronic communication, 2005)

Peak Consumption

The daily consumption estimates listed in Table S8.7 correspond to daily averages based on annual consumption (365 days per year). Because consumption of water has seasonal variations, some assumptions were made to obtain a more representative estimate of the daily consumption during the tracer-test studies, which were done during a high-demand period. Table S8.8 lists assumptions made in reference to the days of operation per year for different water-use categories defined in the WCA (ECG, Inc. 1999).

The cooling systems were assumed to operate from May through October—184 days per year (d/yr), except for building H1 which operates year round (365 d/yr) (ECG, Inc. 1999). Additionally, the individual consumption of each cooling system was assumed to be proportional to its cooling capacity. It was assumed that domestic irrigation is more intensive from May through September (153 d/yr). The offices and work areas are places that typically operate 5 days per week, or 260 d/yr (ECG, Inc. 1999). Schools (tenants) were assumed to operate from August through April (275 d/yr).

Table S8.8. Days of operation per year for different water-use categories, Hadnot Point–Holcomb Boulevard study area, U.S. Marine Corps Base Camp Lejeune, North Carolina, 1998.¹

| Water-use category | Operation | Days per year |
|---------------------------|-----------------------|---------------|
| Family housing | Year round | 365 |
| Bachelor housing | Year round | 365 |
| Offices and work areas | 5 days per week | 260 |
| Mess halls | Year round | 365 |
| Cooling systems | May through October | 184 |
| Bldg. H1 (cooling system) | Year round | 365 |
| Heating plant | Year round | 365 |
| Major tenants | Year round | 365 |
| Schools (major tenants) | August through April | 275 |
| Irrigation | May through September | 153 |

¹Source: ECG, Inc. 1999

For the HBWTP service area, information relating water-use category, days operated per year, and consumption for 2004 are listed in Table S8.9. Consumption estimates are for a typical peak demand day; total estimated consumption is 1.41 MGD. Details pertaining to the assumptions and computations are provided in Appendix S8.2 (Table S8.2.1).

Allocation of consumption to different bachelor housing areas (Table S8.3.1A) was accomplished by assuming that consumption was proportional to the population living in a designated area (e.g., Paradise Point, Figure S8.1). The total consumption estimated for offices and work areas was distributed between the Holcomb Boulevard and Tarawa Terrace water-distribution systems, and this information is in Appendix S8.3 (Table S8.3.1B). As previously noted, the Holcomb Boulevard water-distribution system includes the areas of Paradise Point, Berkeley Manor, Watkins Village, and Midway Park (Figure S8.1); the Tarawa Terrace water-distribution system includes areas of Camp Johnson, Camp Knox Trailer Park, and Tarawa Terrace (Figure S8.3). Tables S8.3.2A, S8.3.2B, and S8.3.2C list the consumption for family housing, heating plants, and tenant buildings, respectively.

Table S8.9. Holcomb Boulevard water treatment plant service area peak consumption, Hadnot Point–Holcomb Boulevard study area, U.S. Marine Corps Base Camp Lejeune, North Carolina, 2004.

[—, not applicable]

| Water-use category | Operation, in days per year | Consumption, in gallons per day |
|------------------------------------|-----------------------------|---------------------------------|
| Family housing | 365 | 696,294 |
| Bachelor housing | 365 | 122,738 |
| Offices and work areas | 260 | 35,741 |
| Mess halls | 365 | 14,502 |
| Cooling systems | 184 | 13,886 |
| Heating plant | 365 | 14,000 |
| Major tenants | ¹ 365 | 121,301 |
| Irrigation | 153 | 390,890 |
| Total estimated consumption | — | 1,409,352 |

¹All major tenant buildings are assumed to operate 365 days per year except for school buildings, which operate 275 days per year

Aggregate Hourly Demand

For the purposes of the current study, the total consumption previously described is assumed to represent total delivered water from the HBWTP (i.e., losses through leaks and pipe breaks are negligible). Consumption data required for model input data, however, are not total consumption data, but are a component or fractional part of total consumption—referred to as demand. (See detailed discussion in the Modeling the Holcomb Boulevard Water-Distribution System—2004 Conditions section.) In some water-distribution system analyses, the terms consumption and demand are used interchangeably. In this study, however, consumption refers to those data derived from either direct metering, when available, or estimation using the WCA methodology. Demand refers to the fractional component of consumption that is applied to model pipelines at specific locations. Thus, hourly estimates of consumption data are needed for water-distribution system modeling to assign appropriate demand values to selected pipeline locations.

Results of the Holcomb Boulevard water-distribution system tracer-test studies were used to estimate hourly consumption by using a system water-balance approach. By using an hourly water balance of the Holcomb Boulevard

water-distribution system, an estimate of the water consumption that occurred during the September–October 2004 tracer test was obtained. Figure S8.20 shows the hourly delivered finished water by the HBWTP and the volume of finished water stored in the HBWTP storage tanks. The delivered finished-water data were obtained from WTP flow charts, and the volume of stored finished water was estimated using 2-min supervisory control and data acquisition (SCADA) system storage tank level data (USMCB Camp Lejeune Public Works Department, Utility Section, 2004). The HBWTP storage tanks were assumed to be cylindrical, constant transverse area tanks.

During the September–October 2004 tracer-test study, an average of 1.37 MGD of finished water was delivered by the HBWTP to the HBWTP service area (D.E. Hill, USMCB Camp Lejeune, Public Works Department Utility Section, electronic communication, 2005). By comparison, the average finished-water consumption obtained by using a water-balance approach for the tracer-test study period was 1.36 MGD (hourly pattern shown in Figure S8.21). This average value is lower than the 1.41 MGD estimated for a peak demand day (Table S8.9). Therefore, computed average demand factors relate the hourly fractional component of total consumption to the average consumption for a 24-hour period (Figure S8.22).

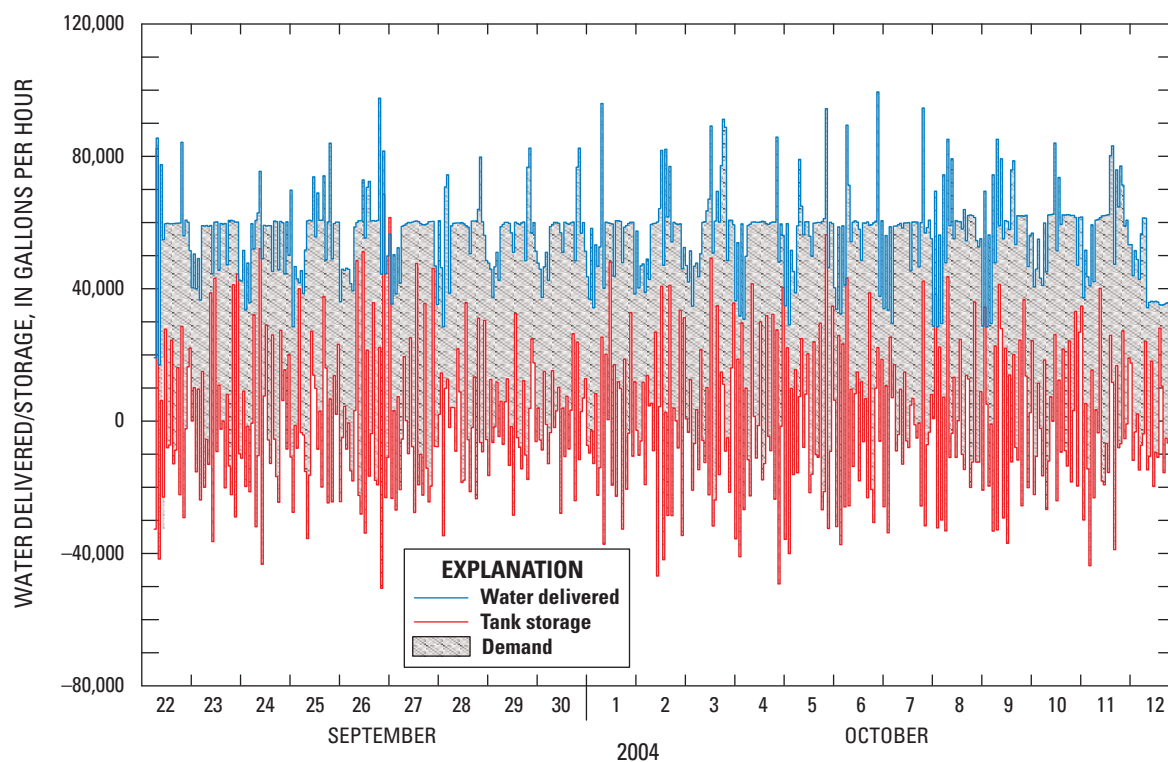

Figure S8.20. Water delivered and stored at the Holcomb Boulevard water treatment plant service area during the tracer test, Hadnot Point–Holcomb Boulevard study area, U.S. Marine Corps Base Camp Lejeune, North Carolina, September 22–October 12, 2004.

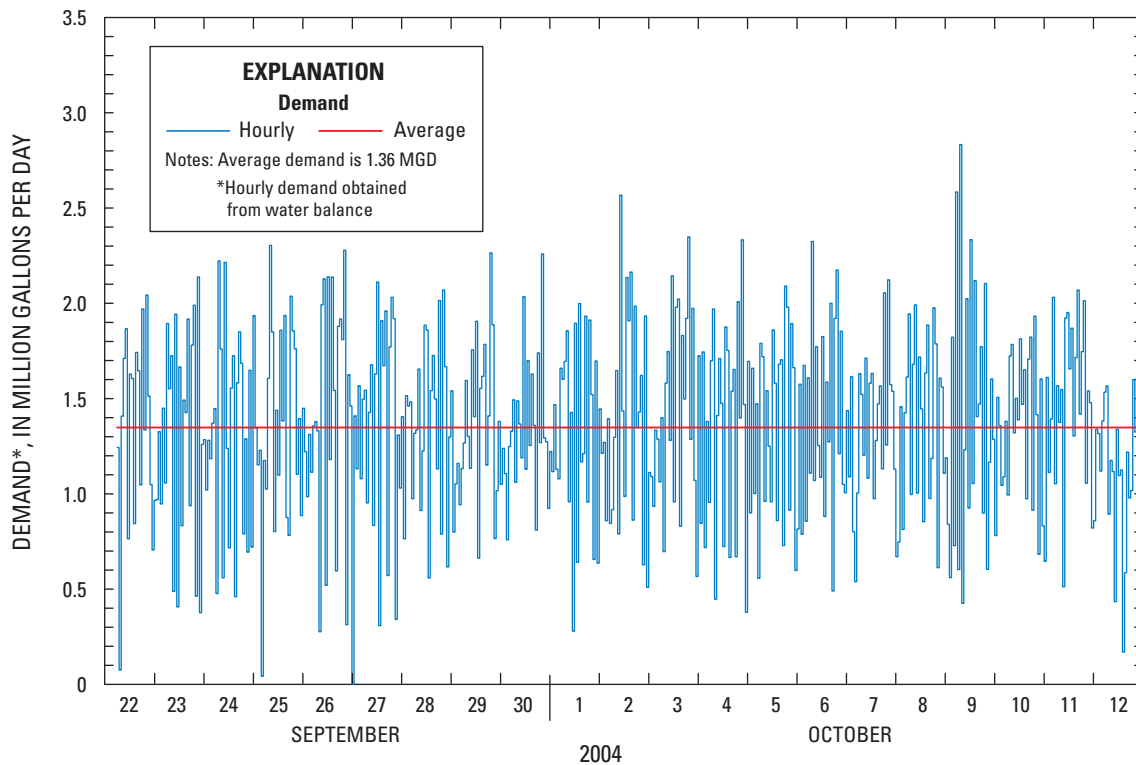

Figure S8.21. Estimated aggregate water demand for the Holcomb Boulevard water treatment plant service area during the tracer test, Hadnot Point–Holcomb Boulevard study area, U.S. Marine Corps Base Camp Lejeune, North Carolina, September 22–October 12, 2004.

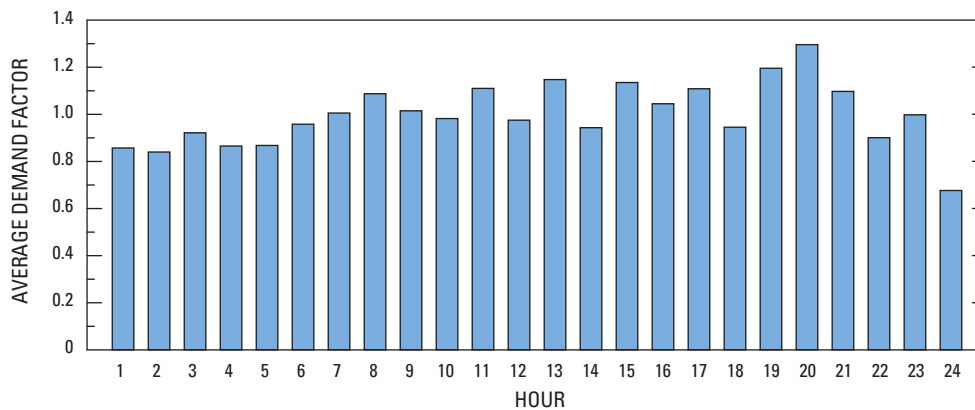

Figure S8.22. 24-hour average demand factors for the Holcomb Boulevard water treatment plant service area during the tracer test; obtained by using the water-balance approach, Hadnot Point–Holcomb Boulevard study area, U.S. Marine Corps Base Camp Lejeune, North Carolina, September 22–October 12, 2004.

Modeling the Holcomb Boulevard Water-Distribution System—2004 Conditions

By using the information and data previously described and data specific to the network of pipelines and other hydraulic appurtenances (e.g., pumps and storage tanks), a water-distribution system network model was developed for the HBWTP service area. The model was calibrated to 2004 conditions. Details of the model and calibration process are described below.

The EPANET 2 water-distribution system model (Rossman 2000) was applied to the Holcomb Boulevard water-distribution system. For 2004 conditions, the HBWTP provided finished water to the Holcomb Boulevard areas, which included the Berkeley Manor, Watkins Village, Paradise Point, and Midway Park housing areas and facilities (Figure S8.3).¹⁸ The HBWTP also provided water to the Tarawa Terrace and Camp Johnson areas. A water-distribution system model of the Tarawa Terrace and Camp Johnson areas was previously developed and calibrated (Maslia et al. 2009) and therefore is not discussed in this report.

Model Overview

The EPANET 2 water-distribution system model (Rossman 2000) tracks the flow of water in each pipe, the pressure at each pipe junction or node, the height of water in each tank, and the concentration of a chemical species throughout the network during a simulation period composed of multiple time steps.¹⁹ In addition to chemical species, water age and source tracing can also be simulated. Information pertinent to the EPANET 2 model development, specific assumptions, and limitations are described in the EPANET 2 Users Manual (Rossman 2000). The water-distribution system network model can be characterized as “skeletonized” or as an “all-pipe” network model. For the Holcomb Boulevard water-distribution model, an “all-pipes” model was used.²⁰

Model Input Requirements

Information required to conduct an EPS hydraulic and water-quality simulation using EPANET 2 includes data describing pipeline characteristics (e.g., lengths,

¹⁸ For modeling purposes, this will be referred to as the Holcomb Boulevard water-distribution system model.

¹⁹ A simulation consisting of multiple time steps is referred to as an extended period simulation or EPS model.

²⁰ Water-distribution systems can be represented in models by using an “all-pipes” network or a network that is reduced through a procedure known as “skeletonization.” Skeletonization is a process of representing the major features of a water-distribution system network by removing non-essential pipelines while still preserving the general hydraulic characteristics of the water-distribution system network.

diameters, and C-factors), finished-water sources (wells and storage tanks), diurnal demand patterns, tank geometries and initial water levels, simulation time parameters, and water-quality parameters.

Specific data input file requirements and formats are provided in the EPANET 2 Users Manual (Rossman 2000).²¹ Data pertinent to the 2004 network pipeline characteristics (e.g., pipe lengths, diameters) required for simulating the September–October 2004 field-test conditions were obtained from information and data supplied by the USMCB Camp Lejeune water utility and from data collected during the 2004 field tests (see the Field-Testing and Data-Collection Activities—2004 Conditions section). Information sources for data and model parameter values are listed in Table S8.10 and are described below.

Junction Data

EPANET 2 identifies junctions (or nodes) as the beginning and ending points associated with each pipe or pipe segment in the model network. Each junction is assigned an alpha-numeric identification label, an elevation, a demand (or consumption) value, and a demand pattern number. Because the goal of the investigation is to conduct a population-based assessment, geospatial location information for pipe junctions, pipelines, and network facilities was required. Geographic coordinates of the model network (in decimal degrees and North Carolina State Plane coordinates) were determined by using global positioning system (GPS) equipment to obtain locations of the test hydrants and tanks previously described. These known coordinates were used to georeference all model nodes (and links) in the water-distribution system network. The all-pipes model of the 2004 Holcomb Boulevard water-distribution system model has 4,785 junctions (three of which are tanks).

Data pertaining to node elevation at pipe-junction locations in the model were obtained from 2-ft contour digital elevation models (DEMs) provided by the U.S. Geological Survey (USGS). These elevations were compared with the elevations surveyed by the USGS at selected points, and they were adjusted when a difference of more than 2 ft was observed.

Hourly demand was originally assigned to model nodes based on data provided in the WCA report (ECG, Inc. 1999). Recall that total consumption for the HBWTP service area was estimated by using information from 1998 (ECG, Inc. 1999). The fractional component of consumption—aggregate hourly demand—was then estimated through a water balance of the system for 2004. The demand data were then allocated to model nodes by using geographic information system (GIS) software to identify model nodes coincident with specific facility and building locations. In EPANET 2, a positive demand value indicates outflow from the network; a negative demand value indicates inflow or supply to the network.

²¹ The EPANET 2 Users Manual is available at <http://nepis.epa.gov/Adobe/PDF/P1007WWU.pdf>.

Table S8.10. Information sources for data and parameter values used to construct models of the water-distribution system serving the Holcomb Boulevard area, Hadnot Point–Holcomb Boulevard study areas, U.S. Marine Corps Base Camp Lejeune, North Carolina.

[ATSDR, Agency for Toxic Substances and Disease Registry; SCADA, supervisory and data acquisition; PEST, parameter estimation]

| Data or model parameter | Source for data or model parameter | Modified during calibration | Comment |
|--|--|-----------------------------|---|
| Physical data | | | |
| Network and pipeline geometry | Water utility electronic data files | No | Network pipelines range from 0.75 inch to 24 inches in diameter |
| Test hydrant locations | Water utility; ATSDR | No | Horizontal and vertical control of hydrants determined by ATSDR staff by use of global positioning system equipment |
| Hydraulic data | | | |
| Pressure data from test hydrants | ATSDR-supplied pressure data loggers | No | 1-minute sampling data |
| Ground and elevated storage tank water levels | Water utility SCADA output to data file | No | 2-minute output; value for each hour of test used for model simulations |
| Groundwater-well production | Water utility SCADA output to computer screen and total daily pumping data | No | ATSDR staff recorded well production from screen output during test |
| High service and booster pump flows | Water utility SCADA output to data file; pump curves | No | 2-minute output—average value over each hour of test used for model calibrations; pump curves used for historical reconstruction model simulations |
| Water-quality data | | | |
| Sodium fluoride concentrations from test hydrants and tank locations | ATSDR-supplied continuous recording water-quality monitoring equipment | No | 15-minute sampling data |
| Model-network data | | | |
| Pipe roughness (“C-factor”) | C-factor tests conducted by ATSDR and literature values | No | ATSDR conducted C-factor tests at several locations throughout the water-distribution system |
| System demand factors | Water utility SCADA production data output to computer screen | Yes | Factors derived from instantaneous production data recorded by ATSDR staff during September–October 2004 tests |
| Nodal demand | Water conservation study (ECG, Inc. 1999) and PEST-12 model (Doherty 2003, 2010) | Yes | Water conservation study conducted during 1998 determined estimated water used by bachelor housing, school, business, etc. PEST-12 model used to better calibrate water-distribution model with different nodal demands |

Tank Geometry and Initial Water-Level Data

Ground-level and elevated storage tanks (Figure S8.3) are associated with model junctions in EPANET 2. Elevated storage tank geometry and elevations were obtained from three main sources: (1) water utility drawings provided by USMCB Camp Lejeune Environmental Management Division during 2004, (2) georeferenced tank database files (e.g., GIS shapefiles provided by USMCB Camp Lejeune), and (3) survey data from the USGS and Eastern Research Group, Inc. (ERG). Identification of each tank, bottom elevations, and diameters are listed in Table S8.11 for the HBWTP service area. For modeling purposes, tanks were assumed to be of cylindrical geometry with a constant transverse area. The initial water level for each tank was determined from data collected by ATSDR staff monitoring the water utility's SCADA system during the 2004 field tests. During initial tracer-test activities, water in some storage tanks apparently did not mix completely or uniformly (see the Field-Testing and Data-Collection Activities—2004 Conditions section, Sautner et al. [2005], and Maslia et al. [2009]). To account for these observations, the default tank mixing model in EPANET 2 (complete mixing) was tested by specifying alternate tank mixing models. EPANET 2 is capable of using four different “simplified” tank

Table S8.11. Elevated storage tank data for the Holcomb Boulevard water-distribution system model, Hadnot Point–Holcomb Boulevard study area, U.S. Marine Corps Base Camp Lejeune, North Carolina, 2004.

| Tank geometry and elevation | Paradise Point: S2323 ¹ | Berkeley Manor: S830 ¹ | Midway Park: LCH4004 ¹ |
|---|------------------------------------|-----------------------------------|-----------------------------------|
| | Feet | | |
| Bottom elevation from ground ² | 98.63 | ³ 97 | 98.63 |
| Ground elevation ⁴ | ² 31.8 | 30.5 | 31.3 |
| Bottom elevation ⁵ | 130.43 | 127.5 | 129.9 |
| Diameter ⁶ | 36 | 48 | 36 |

¹See Figure S8.3 for tank locations

²U.S. Marine Corps Base Camp Lejeune Environmental Management Division (water utility drawings), 2004

³S.J. Whited, U.S. Marine Corps Base Camp Lejeune Environmental Management Division, electronic communication, February 2, 2005

⁴Elevation survey conducted by Eastern Research Group, Inc., at Camp Lejeune, 2004

⁵Elevation=bottom elevation from ground plus ground elevation

⁶Georeferenced tank database (GIS shapefile), U.S. Marine Corps Base Camp Lejeune Environmental Management Division, 2004

mixing models to represent storage tanks that operate in the fill-and-drain mode or with continuous inflow and outflow. The four tank mixing models available in EPANET 2 are (1) complete mixing (CSTR), (2) multi-compartment models, such as two-compartment mixing (2-COMP), (3) first-in, first-out (FIFO) plug flow, and (4) last-in, first-out (LIFO) plug flow (Maslia et al. 2009). The four storage tank mixing models are described in detail by Clark and Grayman (1998) and in the EPANET 2 Users Manual (Rossman 2000).

Pipeline Data

Data pertaining to the pipeline characteristics constituting the distribution system network were retrieved from electronic computer-aided-design files supplied by USMCB Camp Lejeune Public Works Department, Utility Section. Parameters required by EPANET 2 to describe pipes include a pipe identification label, starting and ending node labels, length, diameter, roughness coefficient, and the status of the pipe (open or closed). The all-pipes model of the 2004 Holcomb Boulevard water-distribution system model has 4,909 pipe links (Table S8.2).

To characterize pipe roughness for modeling purposes, the Hazen-Williams C-factor was used. These data were obtained from the literature or estimated from the C-factor tests conducted in the HPWTP and HBWTP service areas (previously described). The material type for pipes composing the network, the number of pipes links, the length of pipe for each material type, and estimated values for the Hazen-Williams C-factor assigned to pipes for use in model calibration are listed in Table S8.12. The model network of the distribution system is composed of pipes ranging in diameter from 0.75 in. to 24 in. Additionally, about two-thirds of the pipes are composed of cast iron, and about one-fourth of the pipes are composed of copper. Information supplied to ATSDR by USMCB Camp Lejeune (georeferenced pipelines database, USMCB Camp Lejeune Environment Management Division, 2004) included data on pipeline material, nominal diameter, length, installation year, retirement year, the number of valves, and location coordinates.

Pumps and Pump Curves

EPANET 2 allows for modeling constant or varying pumping speeds. High-lift service pumps located at the HBWTP and booster pump 742 located near Holcomb Boulevard and Wallace Creek (Figure S8.3) are assigned pump curves (head versus flow relationship) in the water-distribution system model. High-lift service pump curves specific to the Holcomb Boulevard water-distribution system required as part

Table S8.12. Pipe C-factors and materials for the Holcomb Boulevard water-distribution system model, Hadnot Point–Holcomb Boulevard study area, U.S. Marine Corps Base Camp Lejeune, North Carolina, 2004.

[in, inch; —, not applicable]

| Material | C-factor | Source ¹ | Number of pipe links | Percentage of pipe links | Total length (feet) | Percentage of total length |
|--------------------------|----------|--|----------------------|--------------------------|---------------------|----------------------------|
| Cast iron (CI) | 94 | C-factor test | 3,240 | 66.0 | 260,006 | 67.3 |
| Ductile iron (DI) | 140 | Ductile Iron Pipe Research Association 2002 C=140 (24 in.) | 1 | 0.0 | 8,761 | 2.3 |
| Polyvinyl chloride (PVC) | 145 | C-factor test | 81 | 1.7 | 9,726 | 2.5 |
| Asbestos cement (AC) | 150 | Walski et al. 2003, clean C=150 (12.0 in.) | 311 | 6.3 | 27,362 | 7.1 |
| Copper (CU) | 140 | Walski et al. 2003, smooth pipe clean C=140–147 (1.0 in.–3.0 in.) | 1,276 | 26.0 | 80,540 | 20.8 |
| Total | — | — | 4,909 | 100.0 | 386,395 | 100.0 |

¹“C” is the Hazen-Williams roughness coefficient, also referred to as “C-factor” in water-distribution system analyses and modeling

of the historical reconstruction analyses were obtained from Camp Lejeune water utility staff.²² Within the EPANET 2 input file, control statements were used to relate high-lift pump operations to pressures at the elevated controlling tank (S2323, Figure S8.3). Booster pump 742 was operated manually by Camp Lejeune water utility staff. Pump curves were not available and could not be located for the booster pump; however, discussions with Camp Lejeune water utility staff indicated that booster pump 742 pumped about 700 gpm. After reviewing recorded data pertaining to booster pump 742 operations, it was determined that for modeling purposes, booster pump 742 operations were dependent on the time of day the pump was operated (see the Connection of Hadnot Point and Holcomb Boulevard Water-Distribution Systems section for a more detailed discussion).

Pattern Data

EPANET 2 allows for varying of nodal demand values by using a demand pattern factor. System demand factors for the Holcomb Boulevard water-distribution system model were initially determined from a water-balance analysis based on data contained in a water conservation analysis conducted by ECG, Inc. (1999). To improve the model calibration, different demand patterns were assigned to different areas throughout the water-distribution system model (see the Model Calibration—2004 Conditions section for a more detailed discussion).

²² Refer to the High-Lift Service Pumps section for specific pump-curve information (Figures S8.31 and S8.32).

Water-Quality Parameter Data

EPANET 2 can model the movement of non-reactive tracer material through the water-distribution system over time and can model the movement and fate of reactive material as it grows or decays with time. During the Holcomb Boulevard travel time test, the fluoride feed at the HBWTP was shut off and turned back on. Water-quality parameter default values in EPANET 2 were used in the calibrated and historical reconstruction water-distribution system models to simulate the migration and dilution of NaF throughout the water-distribution system. Also, concentrations of all contaminants were assumed to be zero for initial water quality at all model network locations, except at source (injection) locations.

Time Parameter Data

EPANET 2 assumes that demand values, supply rates, and concentrations at source nodes remain constant over a fixed period of time (e.g., 1 hour). However, these parameter values can change from one time period to another. To conduct an EPS, EPANET 2 requires four time parameters: (1) the duration of the simulation, (2) the hydraulic time-step size, (3) the quality time-step size, and (4) the pattern time-step size. For the Holcomb Boulevard water-distribution model, the duration of the simulation was set equal to the duration of the fluoride travel-time test, September 22–October 12 (498 hours). The hydraulic time-step size was set equal to 5 min, and the quality time-step size was set equal to 2 min. The pattern time-step size was set to 1 hour, which is the default pattern time-step size used by EPANET 2.

Model Calibration—2004 Conditions

Model calibration entails adjusting model parameter values until an acceptable match is achieved between measured data and model-simulated values (i.e., pressures and flows at the test hydrants, water levels in the storage tanks, and fluoride concentrations at the test hydrants). A computer model of the water-distribution system reproduces the behavior of a “real-world” hydraulic system as closely as possible in terms of spatial and temporal characteristics. The collection of field data (previously described) provides an opportunity to understand the operation of the real system at a specified number of locations and times. Such efforts are consistent with the findings of the American Water Works Association Engineering Computer Applications Committee which indicate that “true model calibration is achieved by adjusting whatever parameter values need adjusting until a reasonable agreement is achieved between model-predicted behavior and actual field behavior” (AWWA Engineering Computer Applications Committee 1999). Once a model is considered to be calibrated, it can then be used, among other purposes, to estimate hydraulic and water-quality characteristics of the real-world system at locations where measured data are unavailable or unknown, spatially and temporally. Described below are (1) calibration procedures, (2) model parameters that were adjusted during model calibration, and (3) the distribution of demand values for calibration of water-distribution system conditions from 2004.

The Holcomb Boulevard water-distribution system model was calibrated to the hydraulic, system-operational, and water-quality data collected during the September–October 2004 field test. The model was run as an EPS by using 5-minute hydraulic time steps and 1-hour demand-pattern factors originally derived from a system water-balance approach using SCADA system data. Calibrated demand-pattern factors were ultimately determined by using the objective parameter estimation code PEST (Doherty 2003, 2010). Other model parameter values were varied from literature and field-test-derived values by using a manual trial-and-error calibration approach and by using results obtained from applying the objective parameter estimation (PEST).

Discussions with the USMCB Camp Lejeune Public Works Department, Utility Section staff indicated that the network pipes were believed to be very clean, and inspections

had shown very little debris. In addition, most of the pipes (in length) in the Hadnot Point and Holcomb Boulevard water-distribution system are made of PVC and cast iron where the variation in C-factor is negligible (Table S8.12). Therefore, initial estimates for C-factor, obtained from field tests conducted August 25–27, 2004 (Table S8.6) for every pipe material type, were not varied during the calibration process. A sensitivity analysis conducted subsequent to model calibration on the Tarawa Terrace water-distribution system model (Maslia et al. 2009) has shown that variation in C-factor has little influence on system pressures and flow directions.

For modeling purposes, total consumption estimated for the area served by the HBWTP is used as the accounted-for water demand for the area during the tracer test conducted September 22–October 12, 2004. The demand is divided into “demand groups” that correspond to the water-use categories defined in the WCA (irrigation was included with the family housing demand group). Buildings, and their corresponding nodes, having similar water demand patterns were grouped into “categories” (Table S8.2.2). The building water use or type of building was obtained from a georeferenced building database (GIS shapefile) provided by USMCB Camp Lejeune (USMCB Camp Lejeune Environment Management Division, 2004). For the Holcomb Boulevard and Tarawa Terrace service areas, each building (and its associated model node) was linked to a demand group shown in Figure S8.23. Each demand group was further subdivided into categories to establish the water demand pattern.

For the Holcomb Boulevard water-distribution system model, 1,956 nodes were assigned as positive demand nodes. Nodes that could not be categorized because of a lack of information or unknown water use, or whose demand was assumed to be negligible, were associated with the demand group “Unknown/negligible.” The demand value for this group of nodes is set equal to zero (0.0).

Within each demand group, the demand at each node was assumed proportional to the building area it supplies. Cooling systems and heating plants were assumed to have demands proportional to the cooling capacity and steam production, respectively. Table S8.3.3 lists (1) demand groups, (2) demand, in gallons per day, (3) categories, (4) number of demand nodes, and (5) distribution criteria.²³

²³ The demand group “Unknown/negligible” shown in Figure S8.23 is defined as “None” in Table S8.3.3.

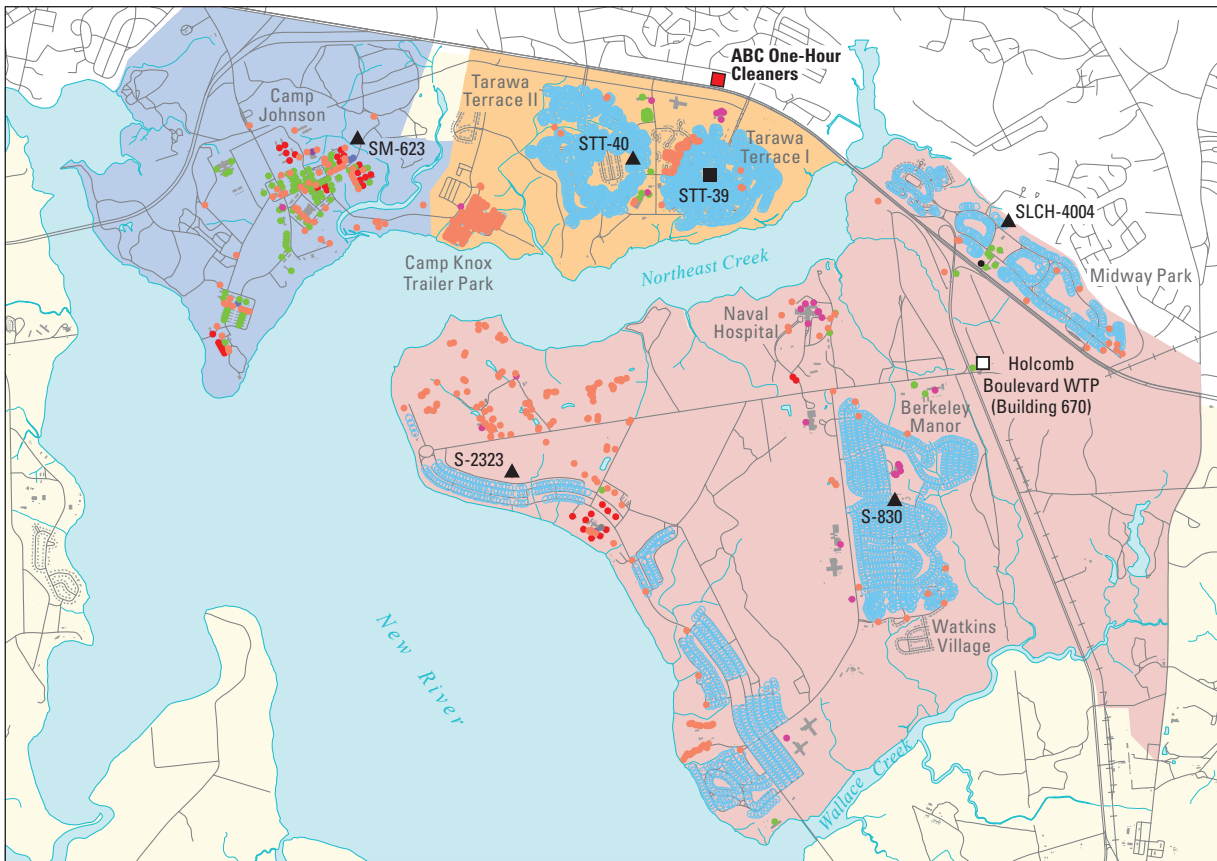

Base from U.S. Marine Corps digital data files

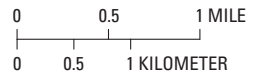

| EXPLANATION | | |
|---|--|---|
| <p>Historical water-supply areas of Camp Lejeune Military Reservation</p> <ul style="list-style-type: none"> Montford Point Tarawa Terrace Holcomb Boulevard Hadnot Point Other areas of Camp Lejeune Military Reservation | <p>Storage tank and identifier</p> <ul style="list-style-type: none"> S-2323 ▲ Elevated STT-39 ■ Ground <p>Water treatment plant (WTP)</p> <ul style="list-style-type: none"> □ | <p>Demand group</p> <ul style="list-style-type: none"> ● Bachelor housing ● Cooling system ● Family housing ● Heating plant ● Mess hall ● Office work area ● Tenants ● Unknown/negligible ● Vehicle washing |

Figure S8.23. Location of model nodes and associated demand groups for the Holcomb Boulevard and Tarawa Terrace water-distribution system models, Hadnot Point–Holcomb Boulevard and Tarawa Terrace study areas, U.S. Marine Corps Base Camp Lejeune, North Carolina, 2004.

Hydraulic and Water-Quality Model Calibrations—Holcomb Boulevard

The Holcomb Boulevard water-distribution system model (calibration based on using the September 22–October 12, 2004, field-test data) was initially divided into nine areas, and “accounted-for demand” was distributed among those areas with a single, constant, 24-hour demand pattern. The HBWTP service area consists mostly of family housing and thus did not require the assignment of different demand-pattern groups. As a consequence, the PEST code (Doherty 2003, 2010) was used to estimate two varying demand factors: one for Midway Park and one for the rest of the Holcomb Boulevard water-distribution system.

Initial simulations of the Holcomb Boulevard water-distribution system model were conducted using a single demand pattern, which was obtained from a water-balance analysis (Figure S8.22). Elevated storage tank S2323 was operated as the controlling tank in the Holcomb Boulevard water-distribution system (Figure S8.3). Data for the measured hydraulic heads and simulated hydraulic heads using a single demand pattern from the water-balance analysis for tanks LCH4004, S2323, and S830 are shown in Figures S8.24, S8.25, and S8.26, respectively, for the period September 23 to September 27, 2004.

to September 27, 2004. Hydraulic heads were computed by using measured storage tank water levels and elevations. Hydraulic heads therefore are available for the duration of the September 22–October 12, 2004, field test.

Measured hydraulic heads in tank LCH4004 were consistently lower than hydraulic heads simulated by using the single demand pattern derived from the water-balance analysis. To objectively improve model simulation of hydraulic head, the PEST code was used to estimate two different demand patterns: (1) a demand pattern for Midway Park and (2) a demand pattern for all other areas of the Holcomb Boulevard water-distribution system.²⁴ The objective function defined in PEST was the sum of the squared differences between measured and simulated hydraulic heads at storage tanks LCH4004, S2323, and S830. Figures S8.24, S8.25, and S8.26 show how simulated heads derived by using the PEST-estimated demand patterns (solid line), more closely resemble the measured hydraulic heads (solid circles) than do the simulated heads derived by using the water-balance approach (dashed line) for the period September 23 to September 27, 2004.

²⁴ In the EPANET 2 model input file, the demand pattern associated with Midway Park is named MIDWAY; the demand pattern associated with the rest of the Holcomb Boulevard water-distribution system is named GENERALHB.

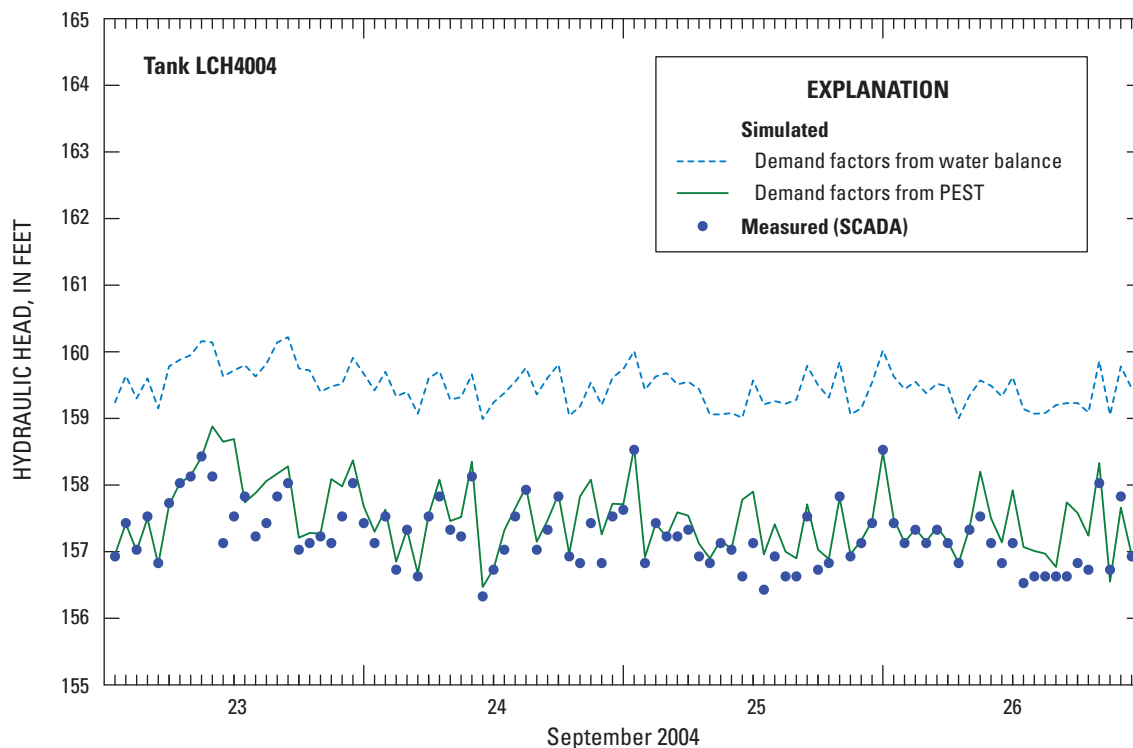

Figure S8.24. Measured (SCADA) and simulated hydraulic head in elevated storage tank LCH4004, Holcomb Boulevard water-distribution system model, Hadnot Point–Holcomb Boulevard study area, U.S. Marine Corps Base Camp Lejeune, North Carolina, September 23–26, 2004. [SCADA, supervisory control and data acquisition]

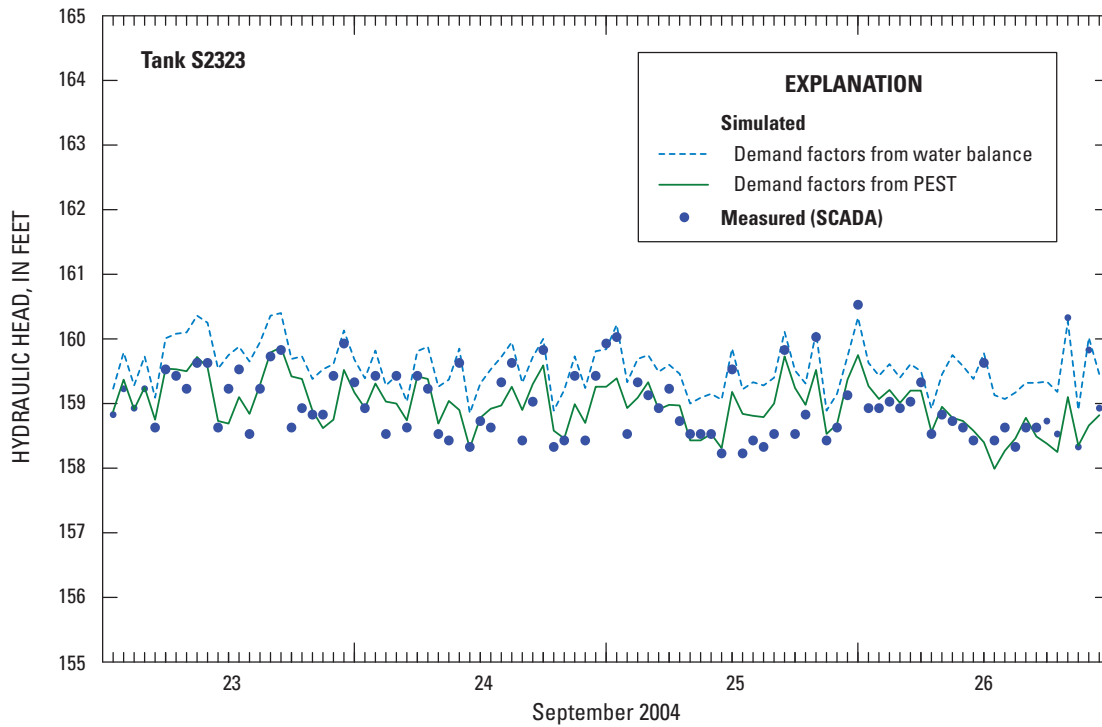

Figure S8.25. Measured (SCADA) and simulated hydraulic head in elevated storage tank S2323, Holcomb Boulevard water-distribution system model, Hadnot Point–Holcomb Boulevard study area, U.S. Marine Corps Base Camp Lejeune, North Carolina, September 23–26, 2004. [SCADA, supervisory control and data acquisition]

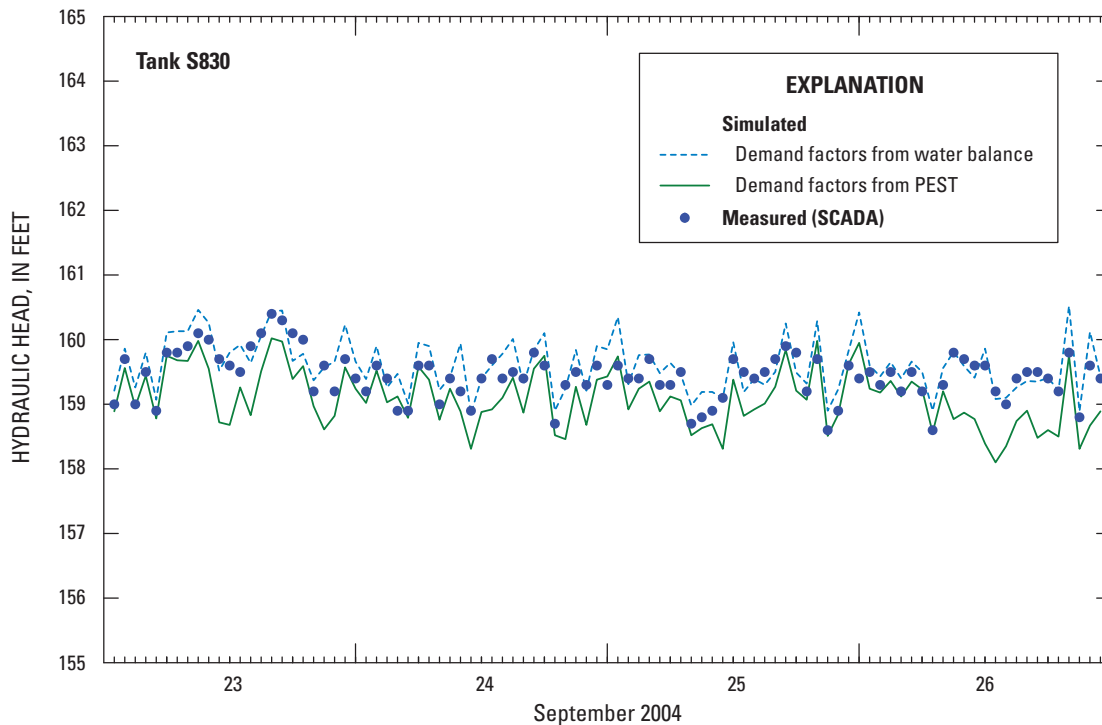

Figure S8.26. Measured (SCADA) and simulated hydraulic head in elevated storage tank S830, Holcomb Boulevard water-distribution system model, Hadnot Point–Holcomb Boulevard study area, U.S. Marine Corps Base Camp Lejeune, North Carolina, September 23–26, 2004. [SCADA, supervisory control and data acquisition]

Using varying demand patterns improved the simulation of heads at tank LCH4004 without significantly changing the simulated heads at storage tanks S2323 and S830, which represents a better calibrated model than when using a single demand pattern. Table S8.13 shows root-mean-squares (RMSs) and correlation coefficients for the simulation using a single demand pattern from the water-balance approach and the same statistics for the simulation using PEST-estimated demand patterns. In terms of RMS, the model performance was improved significantly for tank LCH4004 by using the PEST-estimated demand factors; however, the RMS increased slightly for tank S830. The correlation coefficients decreased when using PEST-estimated demand factors for storage tanks S2323 and S830 but increased for LCH4004.

The fluoride shut off during the tracer test was simulated by using the PEST-estimated demand patterns. Figures S8.27–S8.30 show recorded fluoride concentrations, grab-sample results, and final fluoride simulation results at loggers located throughout the Holcomb Boulevard water-distribution system. Results are shown for the calibrated model using the LIFO storage tank mixing model. Of the four storage tank mixing models available in EPANET (CSTR, 2-COMP, LIFO, and FIFO), the LIFO mixing model provided the best calibration results. The figures show that final fluoride simulation results closely follow the recorded and measured fluoride concentrations. When a “drift” in the recorded fluoride concentrations occurs, the simulation results all closely follow the grab-sample results.

Table S8.13. Root-mean-square error and correlation coefficient for Holcomb Boulevard model results using demand factors from water balance and demand factors from parameter estimation (PEST), Hadnot Point–Holcomb Boulevard study area, U.S. Marine Corps Base Camp Lejeune, North Carolina, 2004.

| Elevated storage tank ¹ | Root-mean-square error | Correlation coefficient |
|---|------------------------|-------------------------|
| Water-balance demand factors | | |
| S2323 | 0.57 | 0.82 |
| S830 | 0.34 | 0.80 |
| LCH4004 | 2.22 | 0.79 |
| Parameter estimation (PEST) demand factors ² | | |
| S2323 | 0.41 | 0.63 |
| S830 | 0.43 | 0.70 |
| LCH4004 | 0.35 | 0.83 |

¹See Figure S8.3 for elevated storage tank locations

²Optimized demand factors derived using the PEST-12 parameter estimation model (Doherty 2003, 2010) and the EPANET 2 water-distribution system model (Rossman 2000)

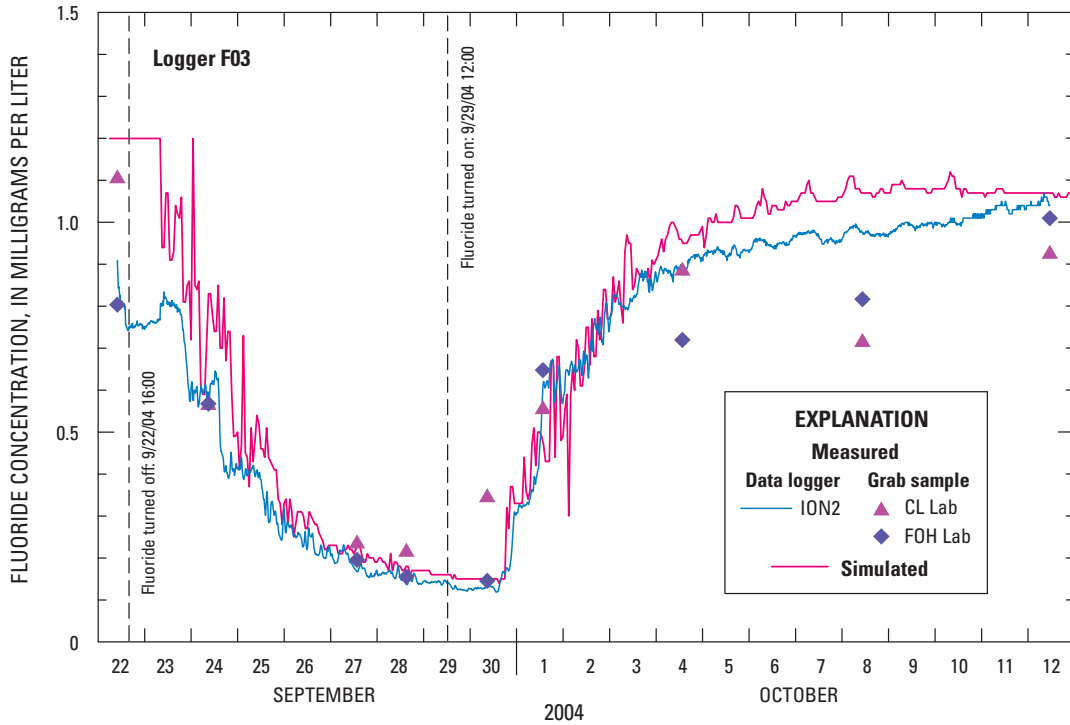

Figure S8.27. Measured (ION2, CL Lab, and FOH Lab) and simulated fluoride concentration data at logger F03, Holcomb Boulevard water-distribution system model, Hadnot Point–Holcomb Boulevard study area, U.S. Marine Corps Base Camp Lejeune, North Carolina, September 22–October 12, 2004. [ION2, data logger; CL Lab, Holcomb Boulevard water treatment plant water-quality laboratory; FOH Lab, Federal Occupational Health laboratory, Chicago, Illinois]

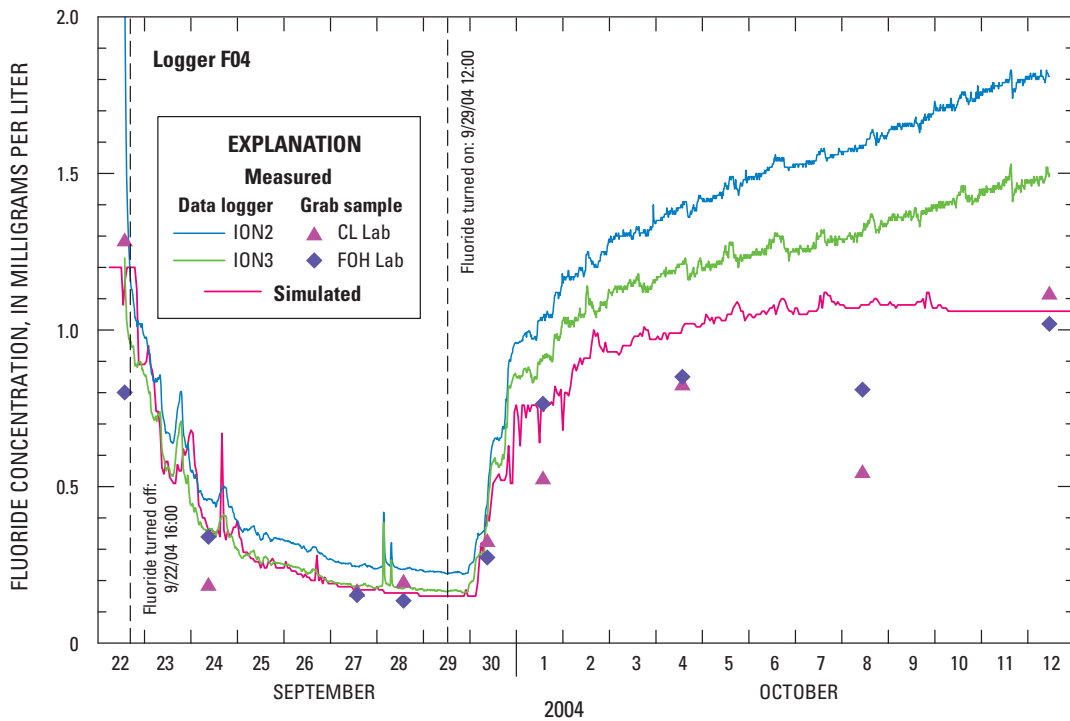

Figure S8.28. Measured (ION2, ION3, CL Lab, and FOH Lab) and simulated fluoride concentration data at logger F04, Holcomb Boulevard water-distribution system model, Hadnot Point–Holcomb Boulevard study area, U.S. Marine Corps Base Camp Lejeune, North Carolina, September 22–October 12, 2004. [ION2 and ION3, data logger; CL Lab, Holcomb Boulevard water treatment plant water-quality laboratory; FOH Lab, Federal Occupational Health laboratory, Chicago, Illinois]

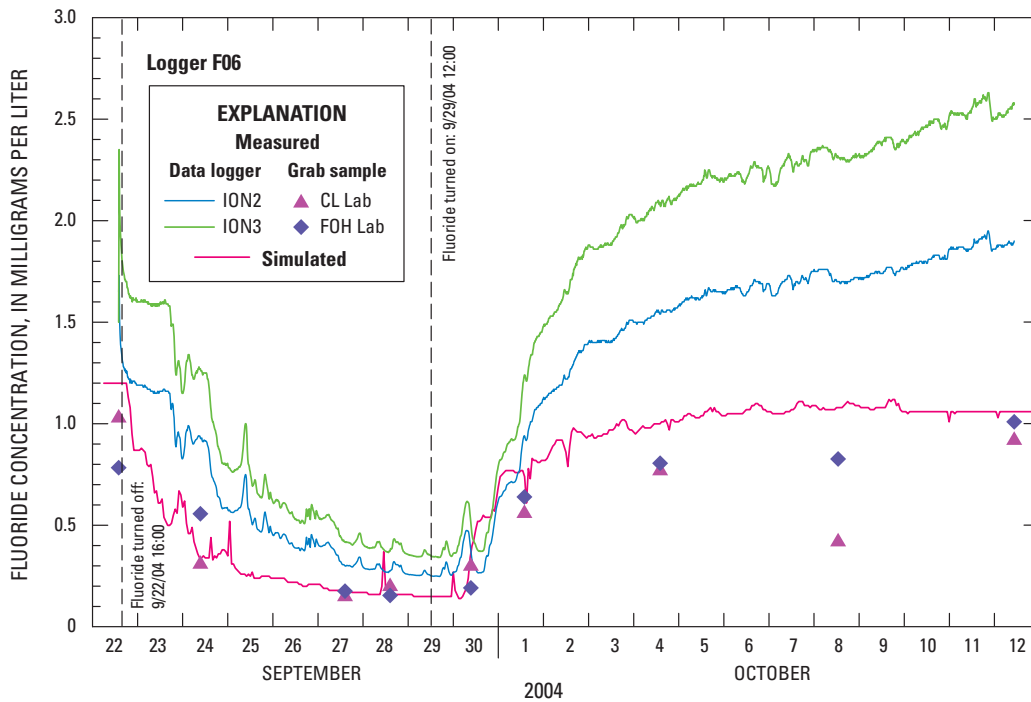

Figure S8.29. Measured (ION2, ION3, CL Lab, and FOH Lab) and simulated fluoride concentration data at logger F06, Holcomb Boulevard water-distribution system model, Hadnot Point–Holcomb Boulevard study area, U.S. Marine Corps Base Camp Lejeune, North Carolina, September 22–October 12, 2004. [ION2 and ION3, data logger; CL Lab, Holcomb Boulevard water treatment plant water-quality laboratory; FOH Lab, Federal Occupational Health laboratory, Chicago, Illinois]

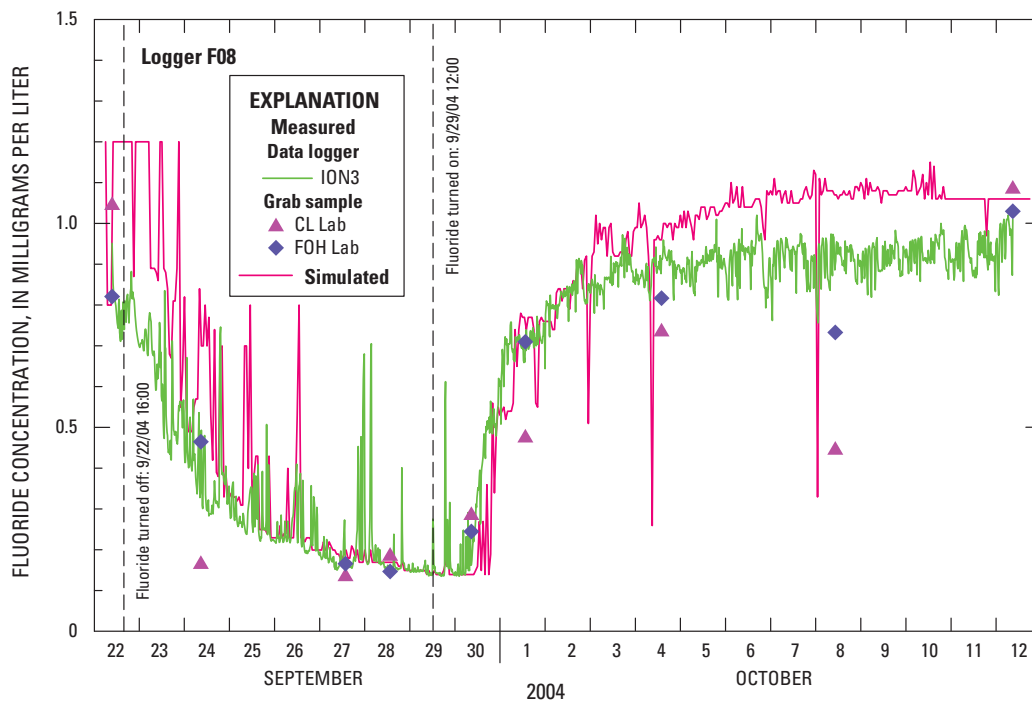

Figure S8.30. Measured (ION3, CL Lab, and FOH Lab) and simulated fluoride concentration data at logger F08 (Tank S2323), Holcomb Boulevard water-distribution system model, Hadnot Point–Holcomb Boulevard study area, U.S. Marine Corps Base Camp Lejeune, North Carolina, September 22–October 12, 2004. [ION3, data logger; CL Lab, Holcomb Boulevard water treatment plant water-quality laboratory; FOH Lab, Federal Occupational Health laboratory, Chicago, Illinois]

Reconstruction of Historical Water-Distribution System Conditions—Holcomb Boulevard

Based on reviews of historical WTP operations and housing information, including discussions with USMCB Camp Lejeune water utility staff, it was determined that the historical water-distribution system serving Holcomb Boulevard was nearly identical to the 2004 water-distribution system. Also, Camp Lejeune water utility staff suggested that water use for 2004 was nearly identical to historical water use. Thus, information and data collected to characterize water-distribution system conditions for 2004 could be used to characterize the historical water-distribution systems. The “all-pipes” model formulation of the water-distribution system network contains all pipe links and storage tanks—typically down to 1-in. or 2-in. residential pipelines. The water-distribution system network represents the 2004 water-distribution system serving the HBWTP service area and is nearly identical to the historical water-distribution system serving this area with the following exceptions.

1. The HBWTP came online during June 1972; prior to that date, the Holcomb Boulevard service area received finished water from the HPWTP (Figure S8.1).
2. The Watkins Village housing area located just south of the Berkeley Manor housing area was constructed during late 1977 and early 1978 (Figure S8.3). Approximately 227 housing units were added in the Watkins Village area, which increased the total housing units served by the HBWTP to about 2,100—a 12% increase in housing units (F.J. Bove, ATSDR, electronic communication, November 21, 2008).
3. A 16-in. pipeline, constructed during 1984, follows SR24 northwest from the HBWTP to ground storage tank STT39 and currently (2013) supplies finished water to STT39, which serves the Tarawa Terrace water-distribution system (Figure S8.3).
4. A 24-in. pipeline, constructed during 1985, trends east-west for about 0.5 mi from Hadnot Point elevated storage tank S5 to the water-distribution system near Holcomb Boulevard (Figure S8.2).
5. A 12-in. pipeline, constructed during 1986, trends east-west from the Tarawa Terrace II housing area to storage tank SM623 and currently (2013) supplies finished water to the storage tank (Figure S8.3).
6. The Tarawa Terrace and Montford Point WTPs were closed during 1987 (Figure S8.3), and currently (2013), the HBWTP provides finished water to these areas.

The “all-pipes” model of the Holcomb Boulevard water-distribution system represents hydraulic and water-quality conditions during the September 22–October 12, 2004, field test. To successfully achieve historical monthly EPSs, the following model parameters were modified in the “all-pipes” network model: (1) high-lift service pumps (#1, #2, #3, #4) were used to fill Holcomb Boulevard controlling elevated storage tank S2323 (Figure S8.3) and (2) one 24-hour average demand pattern was determined from the 498 hourly demand patterns (September 22–October 12 field test). To model individual dry spring and summer months (April–August) for 1972–1985 when contaminated Hadnot Point water was more likely to be transferred from the Hadnot Point water-distribution system to the Holcomb Boulevard water-distribution system, monthly delivered finished-water volumes had to be estimated when data were not available (1972–1979).²⁵ Discussion about these water-distribution system model inputs is presented below.

High-Lift Service Pumps

High-lift pump curves for Holcomb Boulevard pumps are shown in Figures S8.31 and S8.32. The high-lift pumps are operated in conjunction with controlling elevated storage tanks, and the operational procedure is described as follows. Treated water is supplied to the Holcomb Boulevard water-distribution system from the elevated controlling tank S2323 in response to system demand. When the pressure at the controlling tank falls below a pre-set low pressure mark, high-lift pumps located at the HBWTP turn on and fill the tank with finished water from a ground storage tank.²⁶ When the pressure at the controlling tank reaches a pre-set high pressure mark, the high-lift pumps are turned off. The water level in the controlling tank then begins to drop based on water-distribution system demands, until once again, the pressure reaches the pre-set low mark. The aforementioned process is then repeated. Holcomb Boulevard high-lift pumps #1 and #2 are identical (see Figure S8.31 for pump curves), and Holcomb Boulevard high-lift pumps #3 and #4 are identical (see Figure S8.32 for pump curves) (C.N. Rychak, USMCB Camp Lejeune, written communication, August 25, 2010). According to Camp Lejeune water utility staff, if high-lift pumps #1 and #2 were running and more water was needed, booster pump 742 would be used to transfer water from the Hadnot Point water-distribution system to the Holcomb Boulevard water-distribution system instead of using high-lift pumps #3 or #4 (J.R. Hartsoe, USMCB Camp Lejeune, electronic communication, October 31, 2011).

²⁵ A detailed discussion of the transfer of contaminated water from the Hadnot Point water-distribution system to the Holcomb Boulevard water-distribution system during the period 1972–1985 can be found in the section Intermittent Transfers of Finished Water.

²⁶ Although previous discussion in the Water-Distribution Systems section indicated that high-lift pumps are turned on and off based on water-level set points, SCADA data provided to ATSDR by the Camp Lejeune water utility staff listed set points based on pressure recordings.

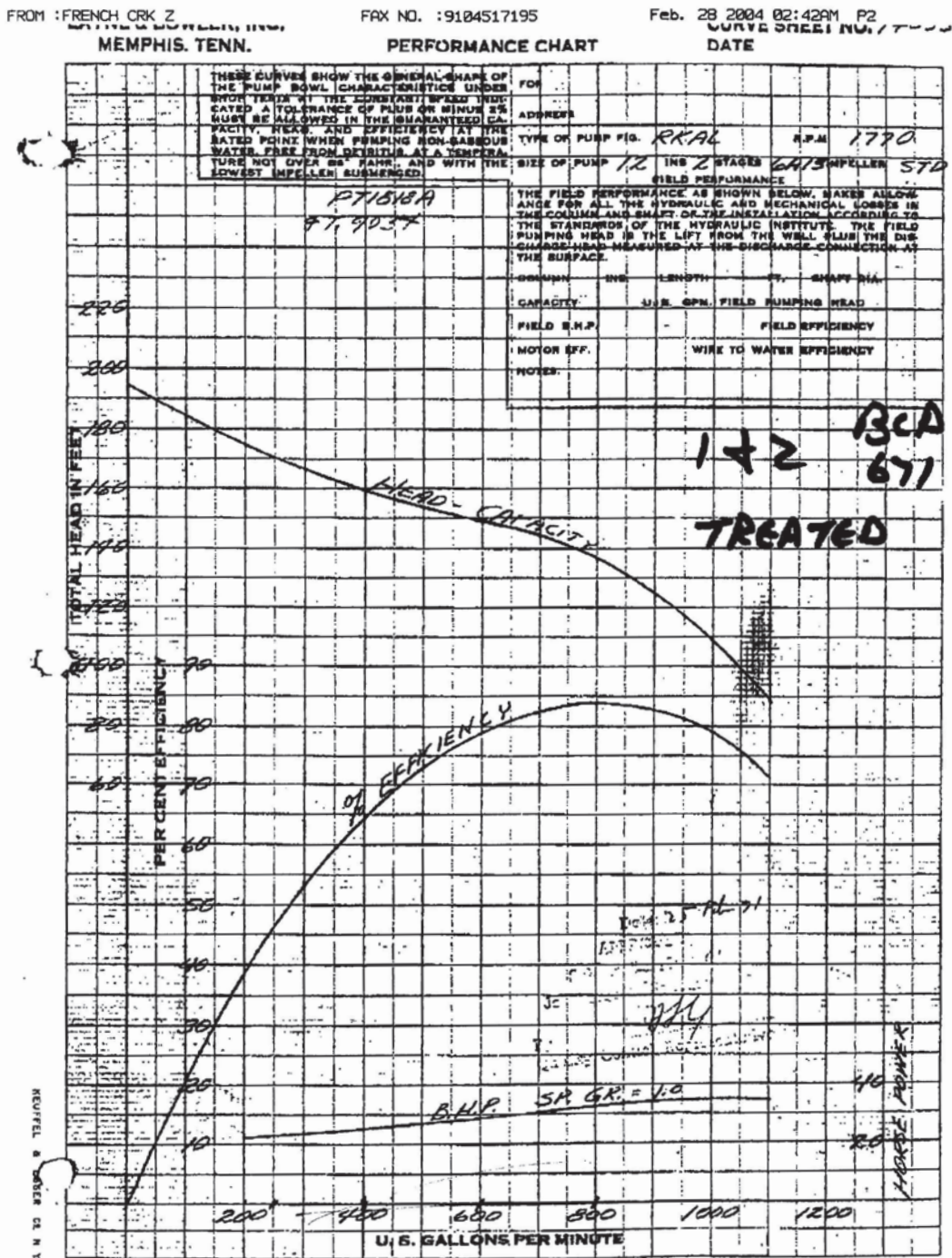

Figure S8.31. Copy of pump curves for Holcomb Boulevard water treatment plant high-lift service pumps #1 and #2, Hadnot Point–Holcomb Boulevard study area, U.S. Marine Corps Base Camp Lejeune, North Carolina, 2004 (from Camp Lejeune Public Works Department, Utility Section).

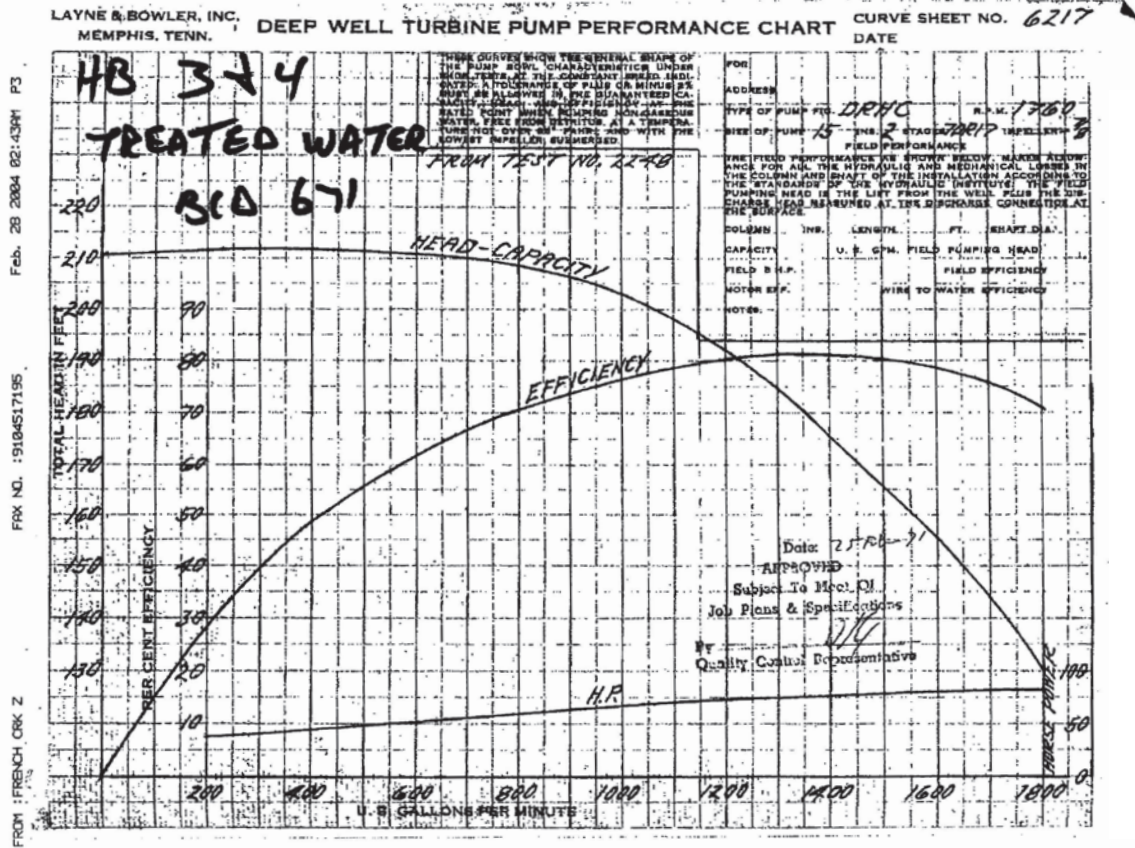

Figure S8.32. Copy of pump curves for Holcomb Boulevard water treatment plant high-lift service pumps #3 and #4, Hadnot Point–Holcomb Boulevard study area, U.S. Marine Corps Base Camp Lejeune, North Carolina, 2004 (from Camp Lejeune Public Works Department, Utility Section).

Estimating Demand Patterns

Demand patterns assigned to the Holcomb Boulevard water-distribution system model were estimated by using the PEST code as part of the model calibration effort, which relied on conditions occurring during the field-test period of September 22–October 12, 2004 (498 hours). To use these demand patterns to reconstruct historical conditions for an EPS, hourly demand pattern values (i.e., EPANET 2 demand factors) were averaged to obtain a 24-hour average

demand pattern. For example, all of the 0100-hr demand factors for the field-test conditions were averaged to derive a single 0100-hr average demand factor; all of the 0200-hr demand factors for the field-test conditions were averaged to derive a single 0200-hr average demand factor, and so forth. Figure S8.33 shows the PEST-calibrated and 24-hour average demand factors applied to all Holcomb Boulevard areas except the Midway Park housing area; the Midway Park PEST-calibrated and 24-hour average demand factors are shown in Figure S8.34.

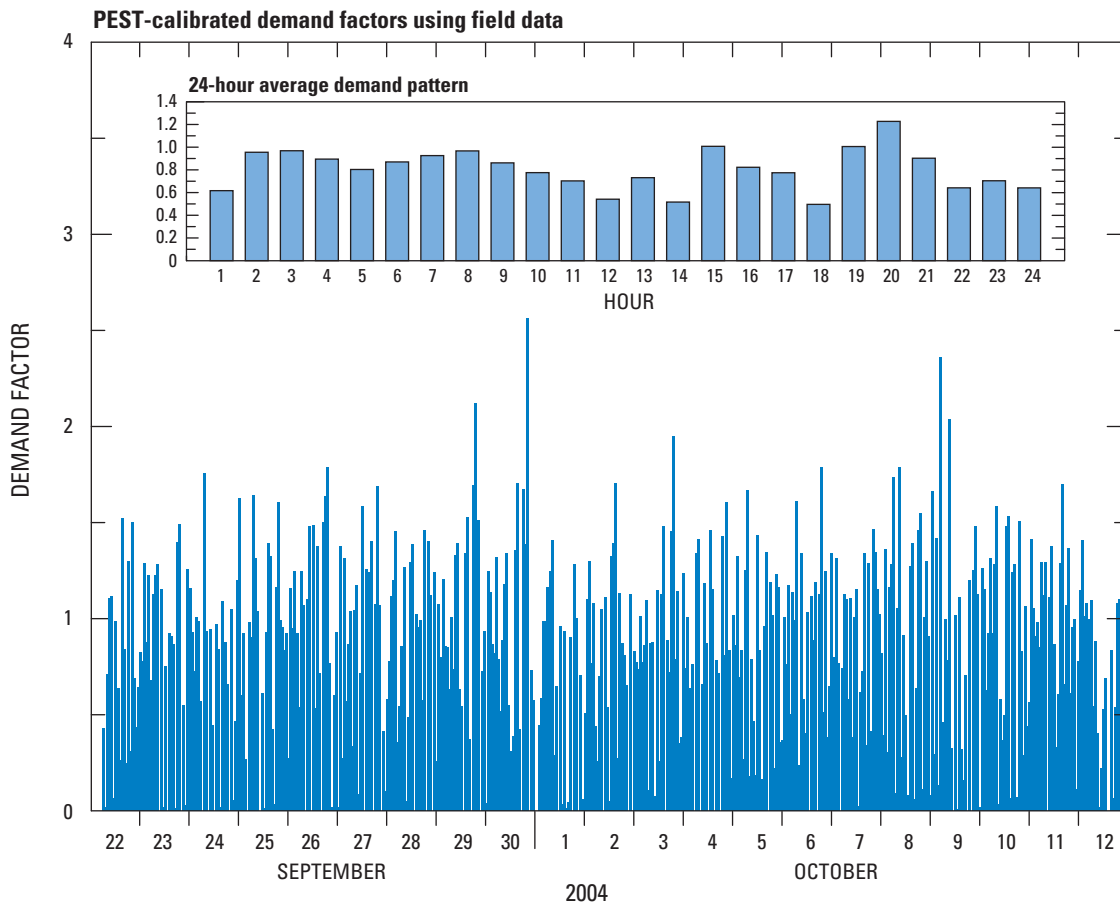

Figure S8.33. PEST-calibrated and 24-hour average demand factors for the Holcomb Boulevard system-wide pattern (GENERALHB) in the EPANET 2 historical water-distribution system model, Hadnot Point–Holcomb Boulevard study area, U.S. Marine Corps Base Camp Lejeune, North Carolina. [PEST, parameter estimation]

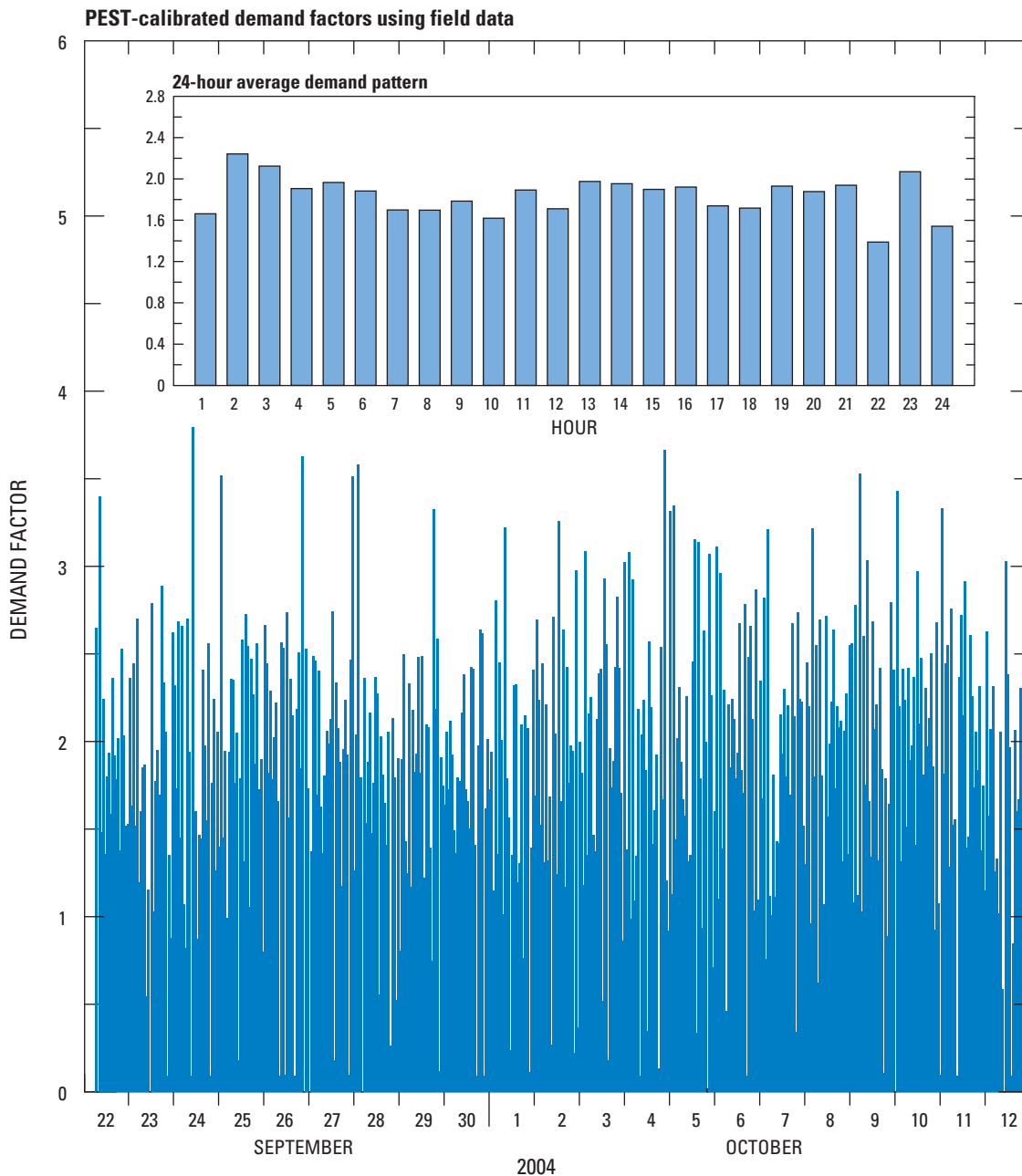

Figure S8.34. PEST-calibrated and 24-hour average demand factors for the Midway Park housing area pattern (MIDWAY) in the EPANET 2 historical water-distribution system model, Hadnot Point–Holcomb Boulevard study area, U.S. Marine Corps Base Camp Lejeune, North Carolina. [PEST, parameter estimation]

Estimating Delivered Finished Water, 1972–1979

Prior to about June 1972, the HPWTP supplied all of the finished water for the Holcomb Boulevard water-distribution system. During June 1972, the HBWTP began delivering finished water to Holcomb Boulevard housing areas and other facilities (S.A. Brewer, USMCB Camp Lejeune, written communication, September 29, 2005). With the exception

of a few months, finished water provided by the HBWTP was recorded by the USMCB Camp Lejeune water utility SCADA system on a monthly basis from January 1980 to December 2008 (Figure S8.35). Table S8.14 lists the data sources and ranges in years of recorded monthly raw and finished-water flows from the HBWTP. Table S8.15 lists the historical record of total monthly finished water delivered to the Holcomb Boulevard water-distribution system.

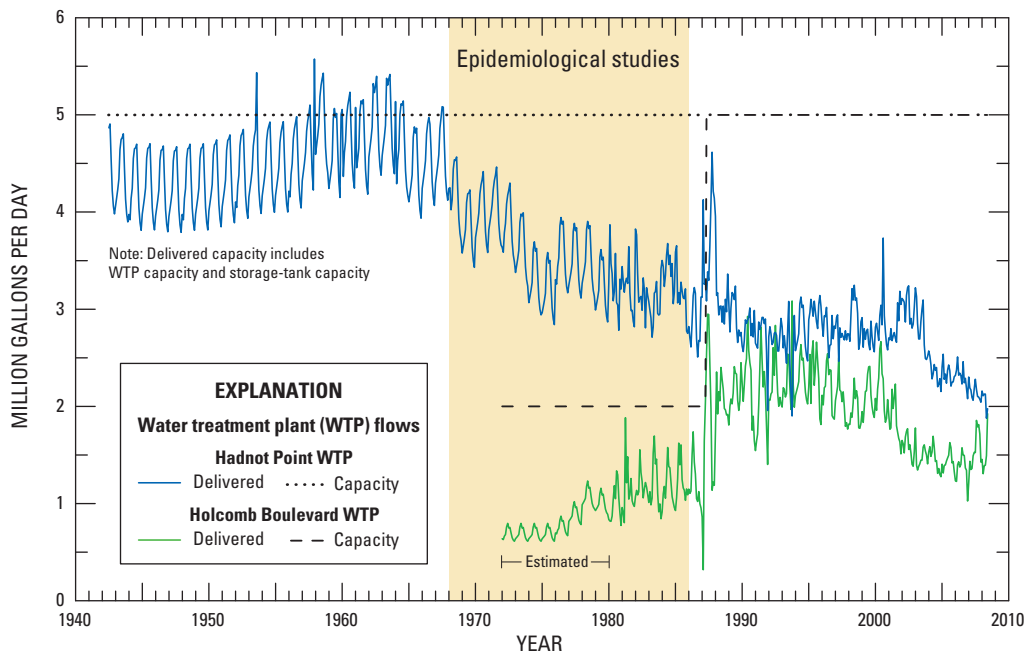

Figure S8.35. Water treatment plant capacity and monthly delivered finished water, in million gallons per day, Hadnot Point–Holcomb Boulevard study area, U.S. Marine Corps Base Camp Lejeune, North Carolina, 1942–2008.

Table S8.14. Holcomb Boulevard raw-water and delivered finished-water data sources, Hadnot Point–Holcomb Boulevard study area, U.S. Marine Corps Base Camp Lejeune, North Carolina, 1980–2008.

[N/A, not available; SCADA, supervisory and data acquisition; NCDENR, North Carolina Department of Environment and Natural Resources]

| Year(s) | Holcomb Boulevard raw-water data sources | Holcomb Boulevard delivered finished-water data sources |
|-----------|--|---|
| 1980–1984 | Camp Lejeune water treatment plant tables ¹ | Camp Lejeune water treatment plant tables ¹ |
| 1985–1986 | N/A | Camp Lejeune Water Document CLW #5005 |
| 1987–1988 | Camp Lejeune water treatment plant tables ¹ | Camp Lejeune water treatment plant tables ¹ |
| 1989–1993 | N/A | Camp Lejeune Water Document CLW #5005 |
| 1994 | N/A | N/A |
| 1995–1999 | NCDENR Report of Operation ¹ | NCDENR Report of Operation ¹ |
| 2000–2008 | Camp Lejeune SCADA ² | Camp Lejeune SCADA ² |

¹ Written communication, Camp Lejeune water utility, 2004–2005

² Electronic communication, Camp Lejeune water utility, 2004–2008

Table S8.15. Historical record of total monthly finished water delivered to the Holcomb Boulevard water-distribution system, Hadnot Point–Holcomb Boulevard study area, U.S. Marine Corps Base Camp Lejeune, North Carolina, 1980–2008.

[MG, million gallons; —, data not available]

| Year | Monthly delivered finished water, in MG ¹ | | | | | | | | | | | | Annual total |
|------|--|-------------------|-------------------|-------------------|-------------------|-------------------|-------------------|-------------------|-------------------|-------------------|-------------------|-------------------|--------------|
| | Jan. | Feb. | Mar. | Apr. | May | June | July | Aug. | Sept. | Oct. | Nov. | Dec. | |
| 1980 | 25.9 | 23.8 | 25.3 | 26.1 | 32.3 | 35.5 | 32.6 | 41.4 | 38.9 | 32.8 | 27.1 | 24.0 | 365.7 |
| 1981 | 29.7 | 25.1 | 24.9 | 56.5 | 37.6 | 44.4 | 32.4 | 33.8 | 37.7 | 31.9 ² | 29.7 ² | 30.1 ² | 414.0 |
| 1982 | 33.2 | 31.8 | 33.8 | 33.6 | 48.2 | 39.6 | 38.1 | 32.8 | 34.5 | 37.7 | 35.1 | 34.0 | 432.4 |
| 1983 | 31.4 | 31.4 | 30.6 | 31.7 | 47.1 | 50.9 | 43.6 | 45.2 | 33.2 | 28.4 | 29.9 | 26.2 | 429.3 |
| 1984 | 28.3 | 31.9 | 36.5 | 31.7 | 39.4 | 47.3 | 42.8 | 42.4 | 36.4 | 33.2 | 30.3 | 29.7 | 429.9 |
| 1985 | 28.8 | 29.7 | 38.9 | 48.7 | 43.4 | 48.1 | 38.7 | 36.0 | 34.1 | 32.0 | 34.5 | 33.8 | 446.6 |
| 1986 | 35.6 | 30.9 | 35.0 | 45.0 | 53.9 | 42.8 | 40.4 | 32.6 | 30.6 | 34.8 | 29.9 | 29.6 | 441.2 |
| 1987 | 26.7 | 8.9 | 51.0 | 61.2 | 78.3 | 88.5 | 91.3 | 75.5 | 59.1 | 35.2 | 36.6 | 36.8 | 649.2 |
| 1988 | 53.7 | 68.3 | 59.6 | 64.6 | 63.8 | 72.0 | 70.8 | 67.5 | 59.4 | 60.9 | 57.3 | 59.4 | 757.2 |
| 1989 | 56.0 | 56.0 | 64.4 | 60.8 | 66.2 | 72.3 | 72.6 | 72.3 | 61.9 | 60.7 | 61.7 | 75.9 | 780.9 |
| 1990 | 69.5 | 57.5 | 68.7 | 72.4 | 77.3 | 87.8 | 79.9 | 75.9 | 71.2 | 54.4 | 57.0 | 51.0 | 822.5 |
| 1991 | 47.9 | 46.0 | 53.1 | 60.3 | 74.0 | 84.5 | 77.1 | 68.2 | 70.8 | 66.7 | 53.6 | 43.5 | 745.6 |
| 1992 | 64.3 | 59.8 | 65.9 | 64.4 | 80.7 | 69.6 | 87.8 | 75.0 | 64.1 | 62.0 | 62.8 | 62.8 | 819.4 |
| 1993 | 61.8 | 61.4 | 67.5 | 62.9 | 66.0 | 76.2 | 78.1 | 68.3 | 59.1 | 95.6 | 66.7 | 61.7 | 825.3 |
| 1994 | 65.5 ² | 60.4 ² | 68.2 ² | 67.6 ² | 77.9 ² | 79.1 ² | 76.8 ² | 77.4 ² | 69.3 ² | 66.6 ² | 62.0 ² | 62.8 ² | 833.4 |
| 1995 | 68.2 | 71.0 | 63.0 | 76.8 | 82.9 | 66.5 | 74.1 | 82.5 | 74.1 | 70.8 | 56.1 | 56.2 | 842.2 |
| 1996 | 65.6 | 58.4 ² | 67.9 | 66.2 | 76.6 | 76.3 | 72.1 | 73.7 | 71.1 | 59.0 | 56.5 | 57.9 | 801.4 |
| 1997 | 63.8 | 59.7 | 68.4 | 75.0 | 67.2 | 64.6 | 63.5 | 66.6 | 59.9 | 55.6 | 55.0 ² | 54.7 | 754.1 |
| 1998 | 56.4 | 50.8 | 59.9 | 56.7 | 63.1 | 68.7 | 64.5 | 67.0 | 62.6 | 55.2 | 53.2 | 56.6 | 714.6 |
| 1999 | 60.3 | 51.4 | 61.5 | 64.6 | 67.0 | 70.0 | 74.6 | 74.8 | 63.5 | 62.0 ² | 57.7 ² | 58.5 ² | 765.8 |
| 2000 | 64.5 | 56.8 | 67.5 | 68.8 | 80.4 | 80.0 | 72.4 | 70.9 | 58.7 | 56.9 | 56.3 | 64.2 | 797.4 |
| 2001 | 59.4 | 49.4 | 55.1 | 65.3 | 61.3 | 62.9 | 69.1 | 55.8 | 52.0 | 51.8 | 49.1 | 46.9 | 678.1 |
| 2002 | 51.1 | 45.2 | 47.2 | 50.5 | 54.0 | 53.1 | 48.3 | 49.8 | 45.6 | 43.5 | 41.5 | 47.5 | 577.3 |
| 2003 | 55.1 | 39.0 | 41.7 | 41.5 | 43.6 | 43.4 | 44.8 | 49.0 | 48.1 | 47.8 | 45.0 | 43.7 | 542.8 |
| 2004 | 47.4 | 46.0 | 46.1 | 45.9 | 52.5 | 47.3 | 44.4 | 44.7 | 39.3 | 42.2 | 39.0 | 39.6 | 534.4 |
| 2005 | 43.6 | 36.8 | 43.2 | 41.9 | 44.6 | 44.1 | 46.4 | 50.4 | 47.3 | 44.0 | 43.0 | 41.1 | 526.3 |
| 2006 | 38.2 | 34.4 | 43.4 | 42.9 | 42.7 | 42.1 | 48.8 | 46.5 | 44.9 | 42.4 | 40.3 | 31.8 | 498.3 |
| 2007 | 37.6 | 40.2 | 41.9 | 40.8 | 46.2 | 45.8 | 47.3 | 57.5 | 53.7 | 56.2 | 51.5 | 44.2 | 562.9 |
| 2008 | 45.1 | 37.9 | 43.1 | 41.8 | 46.3 | 57.7 | 48.5 | 52.8 | 46.4 | 45.9 | 38.4 | 34.7 | 538.7 |

¹Data sources listed in Table S8.14

²Monthly delivered finished-water values estimated from known monthly percentages (1980–2008)

The process used for estimating **annual** finished water delivered by the HBWTP during 1972–1979, when data are not available, is described as follows.

- Annual delivered finished-water rates (in million gallons) first were estimated for 1975–1979 by applying an ordinary least squares (OLS) regression analysis to annual raw and delivered finished water for 1980–2008 using the R software package (R Development Core Team 2010). Equation (S8.3) defines the resulting regression equation derived using the OLS approach:

$$W_F = 0.9216 \times W_R + 12.97394, \quad (\text{S8.3})$$

where

- W_F = finished water delivered by the WTP, in million gallons, and
 W_R = raw water provided to the WTP by water supply wells, in million gallons.²⁷

- Annual delivered finished-water rates for 1972–1974 were assumed to be the same as the annual delivered finished-water rates estimated for 1975 because (a) the Holcomb Boulevard water-distribution system was nearly identical during 1972–1975 and (b) the number of occupied housing units in the Holcomb Boulevard area remained nearly the same during this period. Table S8.16 lists the number of occupied housing units in the HBWTP service area from 1972 to 1984 (F.J. Bove, ATSDR, electronic communication, June 14, 2011). Table S8.17 lists the annual estimated (1972–1979) and recorded (1980–2008) rates of delivered finished water by the HBWTP.

²⁷ Equation S8.3 provides an estimate of total finished water delivered over the period of one year (W_p). Dividing Equation S8.3 by 365 (days per year) results in an annual finished-water rate, in million gallons per day.

Table S8.16. Annual number of occupied family housing units in the Holcomb Boulevard housing area, Hadnot Point–Holcomb Boulevard study area, U.S. Marine Corps Base Camp Lejeune, North Carolina, 1972–1984.¹

| Year | Number of occupied family housing units |
|------|---|
| 1972 | 1,886 |
| 1973 | 1,886 |
| 1974 | 1,891 |
| 1975 | 1,885 |
| 1976 | 1,884 |
| 1977 | 2,007 |
| 1978 | 2,126 |
| 1979 | 2,130 |
| 1980 | 2,128 |
| 1981 | 2,119 |
| 1982 | 2,114 |
| 1983 | 2,114 |
| 1984 | 2,120 |

¹Data source: F.J. Bove, ATSDR, electronic communication, June 14, 2011

Table S8.17. Average annual rate of finished water delivered by the Holcomb Boulevard water treatment plant, Hadnot Point–Holcomb Boulevard study area, U.S. Marine Corps Base Camp Lejeune, North Carolina, 1972–2008.

[MGD, million gallons per day; E, estimated; R, recorded electronically by Camp Lejeune water utility supervisory and data acquisition (SCADA) system]

| Year | Average annual rate of delivered water, in MGD |
|------|--|
| 1972 | 0.69 (E) ¹ |
| 1973 | 0.69 (E) ¹ |
| 1974 | 0.69 (E) ¹ |
| 1975 | 0.69 (E) ² |
| 1976 | 0.75 (E) ² |
| 1977 | 0.88 (E) ² |
| 1978 | 1.07 (E) ² |
| 1979 | 1.00 (E) ² |
| 1980 | 1.00 (R) |
| 1981 | 1.09 (R) |
| 1982 | 1.18 (R) |
| 1983 | 1.18 (R) |
| 1984 | 1.18 (R) |
| 1985 | 1.22 (R) |
| 1986 | 1.21 (R) |
| 1987 | 1.78 (R) |
| 1988 | 2.07 (R) |
| 1989 | 2.14 (R) |
| 1990 | 2.25 (R) |
| 1991 | 2.04 (R) |
| 1992 | 2.24 (R) |
| 1993 | 2.26 (R) |
| 1994 | 2.28 (R) |
| 1995 | 2.31 (R) |
| 1996 | 2.21 (R) |
| 1997 | 2.03 (R) |
| 1998 | 1.96 (R) |
| 1999 | 2.13 (R) |
| 2000 | 2.18 (R) |
| 2001 | 1.86 (R) |
| 2002 | 1.58 (R) |
| 2003 | 1.49 (R) |
| 2004 | 1.46 (R) |
| 2005 | 1.44 (R) |
| 2006 | 1.36 (R) |
| 2007 | 1.54 (R) |
| 2008 | 1.48 (R) |

¹Estimated from 1975 delivered water value

²Estimated using ordinary least squares (OLS) regression and recorded annual raw-water values for corresponding years

The process used for estimating **monthly** finished water delivered by the HBWTP during 1972–1979 is described as follows.

1. Monthly delivered finished-water percentages from 1980–2008 were calculated by dividing known monthly delivered finished-water rates by known annual delivered finished-water rates. Table S8.18 lists the median percentage for each of the 12 months (i.e., January, February, etc.) for 1980–2008.

Table S8.18. Monthly median delivered water percentages used to calculate monthly delivered water volume for 1972–1979, Hadnot Point–Holcomb Boulevard study area, U.S. Marine Corps Base Camp Lejeune, North Carolina, 1980–2008.

| Month | Monthly median percentage (1980–2008) |
|-----------|---------------------------------------|
| January | 7.9 |
| February | 7.2 |
| March | 8.2 |
| April | 8.1 |
| May | 9.4 |
| June | 9.5 |
| July | 9.2 |
| August | 9.3 |
| September | 8.3 |
| October | 8.0 |
| November | 7.4 |
| December | 7.5 |

2. Monthly delivered finished-water rates for 1972–1979 were calculated by multiplying the median percentage for each month (described in step 1) by the annual delivered finished-water rate. Figure S8.35 shows the estimated and recorded monthly delivered finished water in million gallons per day for the HBWTP for 1972–2008.

Table 8.19 lists the HBWTP estimated and recorded delivered finished-water flows (in million gallons) for the months July 1972 to February 1985, inclusive, when Hadnot Point finished water was transferred to the Holcomb Boulevard water-distribution system.²⁸ For each month during 1972–1985 when contaminated finished water was transferred from the Hadnot Point water-distribution system to the Holcomb Boulevard water-distribution system, individual water-distribution system network models having specific delivered finished-water volumes were developed. The demand multiplier for each month was adjusted so that resulting EPANET 2 EPS monthly models were representative of the estimated or recorded delivered finished-water volume. The demand multiplier is a parameter within the hydraulics section of the EPANET 2 program that is used to adjust the values of baseline demands for all junctions and is applied to all demands to make the total system demand vary by a fixed amount (Rossman 2000). Table S8.19 lists the demand multipliers and the monthly EPANET 2 simulated finished-water flows for months when water transfers occurred. All monthly simulated finished-water flows are within 1% of the estimated or recorded finished-water flows.

²⁸ A detailed discussion of the transfer of contaminated water from the Hadnot Point water-distribution system to the Holcomb Boulevard water-distribution system during the period 1972–1985 is provided in a subsequent report section.

Table S8.19. Holcomb Boulevard water treatment plant estimated and recorded flows, EPANET 2 simulated delivered flows, and EPANET 2 demand multipliers for the months when Hadnot Point finished water was transferred to the Holcomb Boulevard water-distribution system, Hadnot Point–Holcomb Boulevard study area, U.S. Marine Corps Base Camp Lejeune, North Carolina, 1972–1985.

[E, estimated by multiplying the median percentage for each month by the annual delivered finished-water flows for a specific year; R, recorded electronically by Camp Lejeune water utility supervisory and data acquisition (SCADA) system]

| Month and year | Holcomb Boulevard water treatment plant | | | EPANET 2 ¹ demand multiplier |
|----------------|---|---|-----------------------------|---|
| | Estimated and recorded flow, in million gallons | EPANET 2 simulated flow, in million gallons | Absolute percent difference | |
| July 1972 | 23.19 (E) | 23.13 | 0.3 | 0.98 |
| June 1973 | 23.89 (E) | 23.82 | 0.3 | 1.04 |
| June 1976 | 26.12 (E) | 26.03 | 0.3 | 1.17 |
| April 1977 | 26.17 (E) | 26.12 | 0.2 | 1.03 |
| May 1977 | 30.16 (E) | 30.14 | 0.0 | 1.32 |
| June 1977 | 30.59 (E) | 30.40 | 0.6 | 1.37 |
| July 1977 | 29.70 (E) | 29.69 | 0.0 | 1.30 |
| August 1977 | 29.94 (E) | 29.85 | 0.3 | 1.31 |
| May 1978 | 36.45 (E) | 36.40 | 0.1 | 1.42 |
| June 1978 | 36.97 (E) | 37.01 | 0.1 | 1.61 |
| July 1978 | 35.89 (E) | 35.89 | 0.0 | 1.39 |
| April 1979 | 29.72 (E) | 29.83 | 0.4 | 1.18 |
| May 1979 | 34.25 (E) | 34.40 | 0.4 | 1.35 |
| June 1979 | 34.73 (E) | 34.78 | 0.1 | 1.40 |
| July 1979 | 33.72 (E) | 33.80 | 0.2 | 1.33 |
| August 1979 | 34.00 (E) | 34.05 | 0.2 | 1.33 |
| June 1980 | 35.52 (R) | 35.47 | 0.1 | 1.33 |
| April 1981 | 56.50 (R) | 56.59 | 0.2 | 2.47 |
| May 1981 | 37.65 (R) | 37.91 | 0.7 | 1.48 |
| June 1981 | 44.44 (R) | 44.39 | 0.1 | 1.81 |
| July 1981 | 32.41 (R) | 32.36 | 0.2 | 1.24 |
| August 1981 | 33.81 (R) | 33.80 | 0.0 | 1.33 |
| April 1982 | 33.65 (R) | 33.76 | 0.3 | 1.35 |
| May 1982 | 48.15 (R) | 48.08 | 0.2 | 1.92 |
| June 1982 | 39.57 (R) | 39.61 | 0.1 | 1.58 |
| July 1982 | 38.14 (R) | 38.27 | 0.4 | 1.49 |
| August 1982 | 32.82 (R) | 32.91 | 0.3 | 1.25 |
| May 1983 | 47.05 (R) | 46.97 | 0.2 | 1.71 |
| June 1983 | 50.86 (R) | 50.98 | 0.2 | 1.90 |
| July 1983 | 43.64 (R) | 43.78 | 0.3 | 1.56 |
| August 1983 | 45.18 (R) | 45.14 | 0.1 | 1.62 |
| April 1984 | 31.65 (R) | 31.69 | 0.1 | 1.14 |
| January 1985 | 28.78 (R) | 28.69 | 0.3 | 1.14 |
| February 1985 | 29.72 (R) | 29.65 | 0.2 | 1.36 |

¹Data source: Rossman (2000)

Analyses of Interconnection Events and Water Transfers Between the Hadnot Point and Holcomb Boulevard Water-Distribution Systems, 1972–1985

The HBWTP began operations during June 1972 with a capacity of about 2 MGD (S.A. Brewer, USMCB Camp Lejeune, written communication, September 29, 2005). The treatment capacity of the plant was increased to 5 MGD probably during 1986 and 1987 (Naval Facilities Engineering Command, Atlantic Division, 1986, CLW #4938). Because of the discovery of several contaminated water-supply wells at Tarawa Terrace during 1985, deliveries of finished water from the HBWTP to Tarawa Terrace began during the summer of 1985. After the removal from service of all Tarawa Terrace water-supply wells during February and March 1987, the HBWTP service area was increased to include all of Tarawa Terrace family housing and the Camp Knox trailer park (Figure S8.3). The HBWTP service area was further increased later in 1987 to include the Camp Johnson area, formerly served by the Montford Point WTP and related water-supply wells (Maslia et al. 2007). The increases in the HBWTP capacity and monthly delivered finished-water flows during 1987 are shown in Figure S8.35 by the spike in the graph. On intermittent occasions, most often during spring and summer months for 1972–1986, finished (and contaminated) Hadnot Point water was transferred to the Holcomb Boulevard water-distribution system to augment increased water use. The following discussion provides data, analyses, and historical reconstruction results for estimating contaminant concentrations in finished water within the Holcomb Boulevard water-distribution system during these intermittent interconnection events.

Connection of Hadnot Point and Holcomb Boulevard Water-Distribution Systems

The Holcomb Boulevard water-distribution system is linked to the Hadnot Point water-distribution system at the Marston Pavilion bypass valve (near McHugh Boulevard and Wallace Creek) and at booster pump 742 (near Holcomb Boulevard and Wallace Creek) (Figure S8.36). For operational reasons, the two water-distribution systems are rarely connected—exceptions being some documented intermittent connections that occurred by using booster pump 742, which was capable of delivering about 700 gpm, during the dry spring and summer months (April–August) for 1978–1986 (USMCB Camp Lejeune water documents CLW #6774–#8761). Typically booster pump 742 was used to transfer finished water from the Hadnot Point water-distribution system to the Holcomb Boulevard water-distribution system to account for water shortages caused by irrigating the Scarlet and Gold Golf Courses located in the Paradise Point area of the HBWTP service area (Figure S8.36).

Water Use for Golf Course Irrigation

Prior to 1988 when a pond water irrigation system was installed, Holcomb Boulevard finished water was used to irrigate the Scarlet and Gold Golf Courses (C.A. Fletcher, ATSDR, electronic communication, September 22, 2010). The Scarlet and Gold golf courses used around 16 million gallons (Mgal) of water during a 12-month irrigation period, which equals about 44,000 gallons per day (gal/d) (C.M. Rychak, USMCB Camp Lejeune, electronic communication, July 27, 2010). Similar water-use rates of about 50,000 gal/d were also reported by USMCB Camp Lejeune Public Works Department, Utility section staff who worked at the WTPs between 1968 and 1985 (Michael Partain, Camp Lejeune Community Assistance Panel, electronic communication, September 22, 2010). After several discussions and email correspondence with past and present golf course and utility section staff, the following golf course characteristics were determined.

Gold Golf Course

- The Gold course is 18 holes long, and each hole has one tee and one green, which is where the sprinkler heads are located.
- The 36 greens and tees are watered for 10 minutes, which equals 360 minutes or 6 hours of total watering time.
- The Gold course used four sprinkler heads at one time for each tee and green, each supplying 25 gpm of water, which equals a total of 100 gpm.
- Supplying 100 gpm of water for 6 hours equals a total of 36,000 gal/d.

Scarlet Golf Course

- The Scarlet course is 18 holes long, and each hole has one tee and one green, which is where the sprinkler heads are located.
- The 36 greens and tees are watered for slightly less than 7 minutes, which equals 240 minutes or 4 hours of total watering time.
- The Scarlet course used two sprinkler heads at one time for each tee and green, each supplying 25 gpm of water, which equals a total of 50 gpm.
- Supplying 50 gpm of water for 4 hours equals a total of 12,000 gal/d.

During every dry spring and summer day in the historical monthly (April–August) water-distribution system models for 1972–1985, a demand of 100 gpm was placed at a model location (junction or node) used to represent the Gold Golf Course irrigation (Figure S8.36). Demand was simulated as occurring from 2200 hours to 0400 hours. Another demand of 50 gpm was placed at a model junction to represent the Scarlet Golf Course irrigation. The Scarlet Golf Course demand was simulated

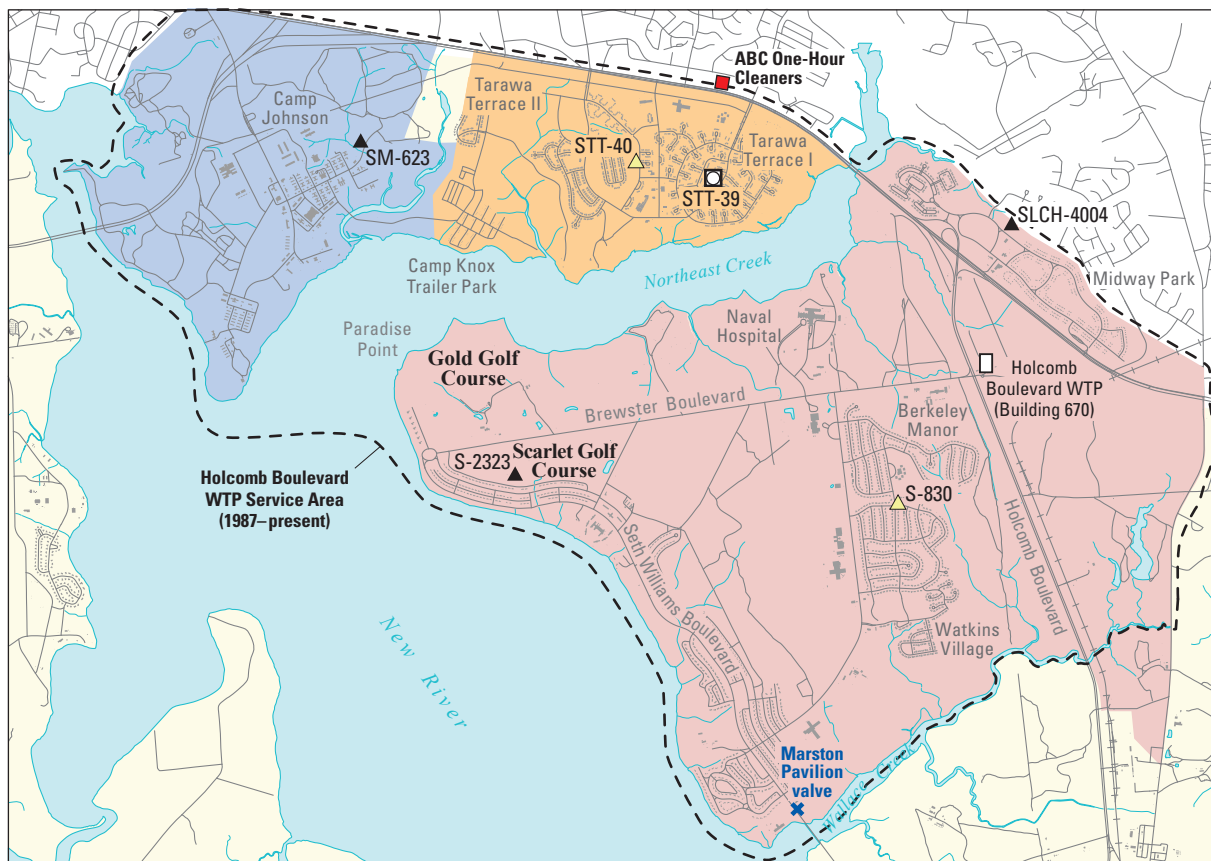

Base from U.S. Marine Corps digital data files

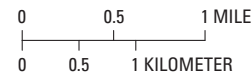

EXPLANATION

- | | | | |
|--|--|---|--|
| Historical water-supply areas of Camp Lejeune Military Reservation | | Storage tank and identifier | |
| Montford Point | | S2323 Elevated—Controlling | |
| Tarawa Terrace | | S830 Elevated | |
| Holcomb Boulevard | | STT39 Ground—Finished water | |
| Hadnot Point | | | |
| Other areas of Camp Lejeune Military Reservation | | Water treatment plant— | |
| | | Name and length of operation | |
| | | Holcomb Boulevard: June 1972–present | |
| | | Tarawa Terrace: 1952–1987 | |

Figure S8.36. Location of Gold and Scarlet Golf Courses in the Holcomb Boulevard water treatment plant service area, Hadnot Point–Holcomb Boulevard study area, U.S. Marine Corps Base Camp Lejeune, North Carolina.

as occurring from 0400 hours to 0800 hours. The combined reconstructed demand assigned to model nodes representing both Scarlet and Gold Golf Courses equals 48,000 gal/d, which is consistent with estimated water use reported by past and current golf course and water utility section staff.

The water-distribution system interconnection locations previously described (Marston Pavilion valve and booster pump 742) are represented in the EPANET 2 network model as Hadnot Point finished-water infinite reservoirs (Figure S8.36). A pump with a rated capacity of about 700 gpm (representing booster pump 742) was added to the

water-distribution system model on the downstream side of the infinite reservoir located near the intersection of Holcomb Boulevard with Wallace Creek. Representing the Hadnot Point water-distribution system as infinite reservoirs at the Marston Pavilion valve and booster pump 742 locations within the Holcomb Boulevard water-distribution system network model substantially simplified the network model and the amount of computational time required to generate and run each of the individual monthly models. In essence, this simplified approach eliminated the need to develop and calibrate a model to represent the Hadnot Point water-distribution system.

Intermittent Transfers of Finished Water

During the period June 1972–December 1985, the Hadnot Point and Holcomb Boulevard water-distribution systems were intermittently interconnected during dry spring and summer months (April–August). During these periods, contaminated finished water from the Hadnot Point water-distribution system was transferred to and distributed within the uncontaminated Holcomb Boulevard water-distribution system. Operational records indicating booster pump 742 operations and Marston Pavilion valve openings are scantily documented. Interconnection information and data that are available were obtained from the USMCB Camp Lejeune water utility log books (Camp Lejeune Water Documents CLW #7023–CLW #8735).

Between June 1972 and December 1985, the interconnection of the Hadnot Point and Holcomb Boulevard water-distribution systems was most often accomplished by operating booster pump 742. These data, representing the number of interconnection events, are shown graphically in Figure S8.37. Note, all contaminated Hadnot Point water-supply wells were taken out of service after February 1985

(Sautner et al. 2013). On one occasion, the bypass valve at Marston Pavilion (Figure S8.36) was documented to have been open during the 8-day period of January 28–February 4, 1985 (Camp Lejeune Water Documents CLW #8109 and CLW #8117) when the HBWTP was shut down due to a gasoline odor complaint from two customers (Camp Lejeune Water Document CLW #4514). When the Marston Pavilion bypass valve is open, finished water is allowed to flow freely from the Hadnot Point water-distribution system to the Holcomb Boulevard water-distribution system.

Because of the interconnection of the Hadnot Point and Holcomb Boulevard water-distribution systems, a more complex analysis was necessary (compared to the simple mixing-model approach described by Maslia et al. 2013, Equations A1 and A2) to determine the concentration of finished water from the Hadnot Point water-distribution system in the Holcomb Boulevard water-distribution system during periods of interconnection.²⁹ This required the application of the EPANET 2 water-distribution system model (Rossman 2000) and EPS. The EPANET 2 water-distribution system model

²⁹ See the Historical Reconstruction Results for Intermittent Transfers of Finished Water section.

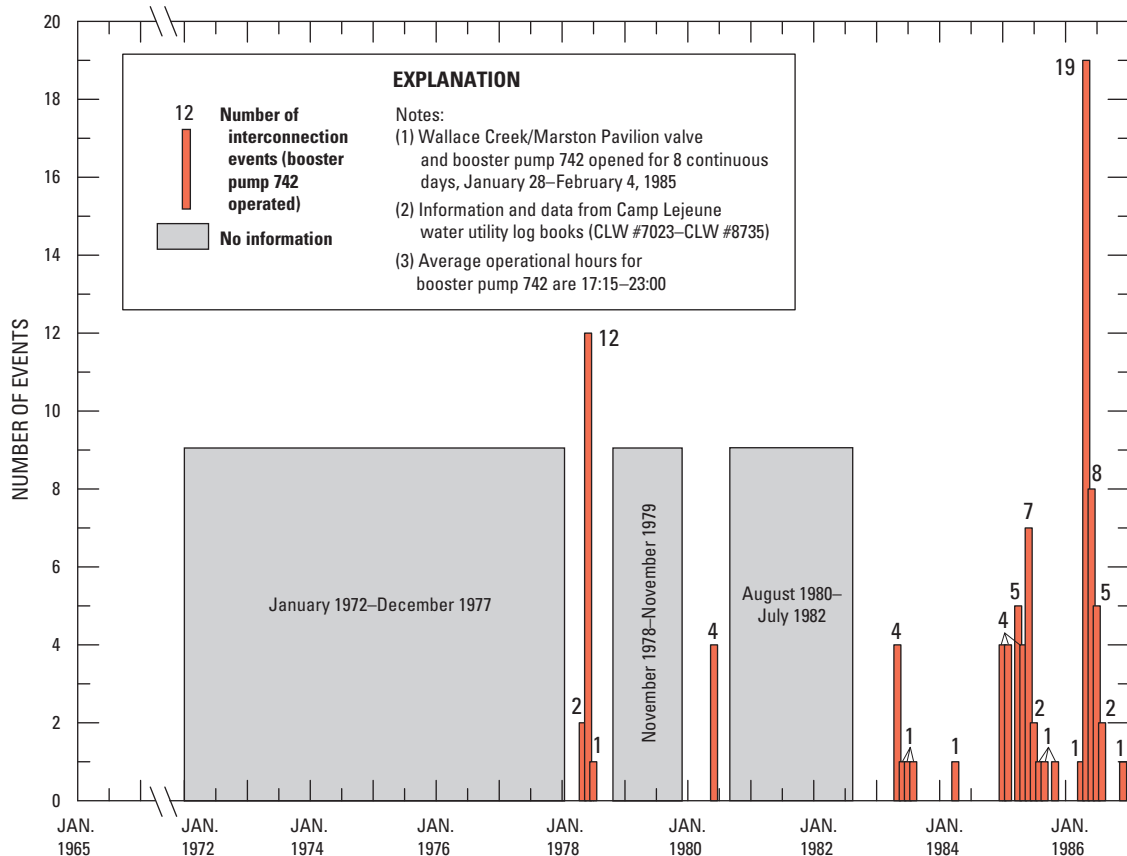

Figure S8.37. Number of interconnection events when Hadnot Point finished water was transferred to the Holcomb Boulevard water-distribution system, Hadnot Point–Holcomb Boulevard study area, U.S. Marine Corps Base Camp Lejeune, North Carolina, 1972–1986.

was calibrated for the Holcomb Boulevard water-distribution system by using field data collected by the ATSDR water-modeling team; field data represented operational conditions during 2004 (Sautner et al. 2005, 2007). EPSs were used to reconstruct water-distribution system flow and mass transport patterns during discrete interconnection events (Figure S8.37) when booster pump 742 (Figure S8.36) was intermittently operated, resulting in the transfer of contaminated finished water from the Hadnot Point water-distribution system to the “uncontaminated” Holcomb Boulevard water-distribution system. Pipelines represented in the water-distribution system network model are coincident with locations of streets within the HPHB study area (Figure S8.1) (e.g., see Maslia et al. [2009, Figure I3]). As previously discussed, the network representation of the “real world” Hadnot Point and Holcomb Boulevard water-distribution systems was simplified by representing the Hadnot Point water-distribution system as an infinite reservoir. To simulate the estimated percentage of Hadnot Point contaminated water at locations throughout Holcomb Boulevard, 100 units of a conservative tracer (e.g., 100 micrograms per liter [$\mu\text{g/L}$]) were placed in the model’s reservoir locations, which represented finished (contaminated) Hadnot Point water that would have been transferred to the Holcomb Boulevard water-distribution system through the Marston Pavilion valve and booster pump 742.

Determining Interconnection Events by Using Markov Analysis

Because information pertaining to times when interconnection events occurred is limited and for some years unknown (e.g., 1972–1977, Figure S8.37), a Markov process (Ross 1997) was applied by using available information to estimate the probability and number of monthly interconnection events that occurred during the months of April–August for 1972–1985.³⁰ The Markov analysis first estimates the number of historical booster pump opening events on a yearly basis. Next, the numbers of events are distributed among the dry months (April–August) during each year. Graphical techniques and data analyses (of daily recordings of temperature, precipitation, and raw-water volume in the HBWTP) were then used to estimate the occurrence of daily finished-water transfers during individual months. Table S8.20 lists the number of recorded interconnection events and the number of monthly events predicted by using a Markov Chain analysis for the period 1972–1985. The results show that predictions using the Markov methodology analysis are reasonable and the outcomes are useful for water-distribution model simulations. Appendix S8.4 describes the Markov analysis methodology.

³⁰ A Markov process analyzes the tendency of one event to be followed by another event based on the sequence of events. By using this analysis, one can generate a new sequence of random but related events, which will look similar to the original. A stream of events is called a Markov Chain.

Table S8.20. Number of recorded and predicted interconnection events when Hadnot Point finished drinking water was transferred to the Holcomb Boulevard water-distribution system, Hadnot Point–Holcomb Boulevard study area, U.S. Marine Corps Base Camp Lejeune, North Carolina, 1972–1985.

[Rec., recorded; Pred., predicted; N/A, not applicable; —, data not available]

| Year | April | | May | | June | | July | | August | |
|-------------------|-------------------|--------------------|------|-------|------|-------|------|-------|--------|-------|
| | ¹ Rec. | ² Pred. | Rec. | Pred. | Rec. | Pred. | Rec. | Pred. | Rec. | Pred. |
| 1972 ³ | N/A | N/A | N/A | N/A | — | 0 | — | 0 | — | 0 |
| 1973 | — | 0 | — | 0 | — | 1 | — | 0 | — | 0 |
| 1974 | — | 0 | — | 0 | — | 0 | — | 0 | — | 0 |
| 1975 | — | 0 | — | 0 | — | 0 | — | 0 | — | 0 |
| 1976 | — | 0 | — | 0 | — | 1 | — | 0 | — | 0 |
| 1977 | — | 1 | — | 1 | — | 1 | — | 1 | — | 1 |
| 1978 | 0 | 0 | 3 | 2 | 12 | 3 | 1 | 1 | 0 | 2 |
| 1979 | — | 1 | — | 1 | — | 2 | — | 1 | — | 1 |
| 1980 | 0 | 0 | 0 | 1 | 4 | 2 | 0 | 1 | — | 2 |
| 1981 | — | 16 | — | 3 | — | 3 | — | 1 | — | 1 |
| 1982 | — | 2 | — | 5 | — | 2 | — | 2 | 0 | 1 |
| 1983 | 0 | 1 | 4 | 4 | 1 | 7 | 1 | 2 | 1 | 2 |
| 1984 | 1 | 1 | 0 | 3 | 0 | 3 | 0 | 2 | 0 | 2 |
| 1985 ⁴ | 5 | 5 | 4 | 3 | 7 | 5 | 2 | 2 | 1 | 1 |

¹ Recorded values obtained from Camp Lejeune water utility log books (U.S. Marine Corps Base Camp Lejeune Water Documents CLW #7025–CLW #8735)

² Predicted interconnection events derived from application of Markov Chain analysis

³ Prior to June 1972, the Hadnot Point water treatment plant supplied all of the finished water to Holcomb Boulevard family housing areas

⁴ For period of January 27–February 4, 1985, booster pump 742 operated continuously due to shut down of Holcomb Boulevard water treatment plant; this continuous event is not included in the Markov Chain analysis

When applying the Markov Chain monthly predicted events to the individual EPS monthly water-distribution system models, it is important to determine on which days of the month the events occurred and duration of each event. Based on documented interconnection events, it was determined that typically booster pump 742 was turned on around 1715 hours and turned off around 2300 hours (Camp Lejeune Water Documents CLW #7023–CLW #8735). For each predicted booster pump 742 operational event, the typical on-off operating times identified above were used. In addition to booster pump 742 operations, determining dry periods during each month was required. This was accomplished by analyzing graphs of daily rainfall and temperature data for each individual month and identifying the most likely days during which predicted interconnection events would have occurred.

Historical Reconstruction Results for Intermittent Transfers of Finished Water

By using the Markov Chain analysis when data were unavailable or unknown, EPANET 2 EPSs were conducted for each month when water transfers occurred by operating booster pump 742 (interconnection event). Note, for the 8-day period of January 28–February 4, 1985, the HBWTP was shut down (Camp Lejeune Water Documents CLW #8109 and #8117). During this period, all Holcomb Boulevard family housing areas were continuously supplied with contaminated Hadnot Point finished water. Results for each Holcomb Boulevard housing area for 1972–1985 are listed in Table S8.21.³¹ Results should be interpreted as monthly mean concentrations for a specific housing area assuming a source (Hadnot Point finished water) concentration of 100 units (100 mg/L). Knowing a specific reconstructed finished-water concentration at the HPWTP (Appendix A7), the resulting finished-water concentration at a specific Holcomb Boulevard housing area was calculated for the period July 1972–December 1985. These finished-water concentrations at specific housing areas were determined by multiplying the reconstructed finished-water concentration at the HPWTP with the percentage of Hadnot Point finished water at each Holcomb Boulevard housing area (Table S8.21). For example, the reconstructed (simulated) finished-water TCE concentration at the HPWTP for May 1982 was 438 mg/L (Appendix A7). Based on the percentage of Hadnot Point water distributed to the Paradise Point, Midway Park, Berkeley Manor, and Watkins Village housing areas of 0%, 1%, 4%, and 3%, respectively (Table S8.21, May 1982), the resulting concentrations of TCE (rounded) would be 1 mg/L for Paradise Point, 6 mg/L for Midway Park, 20 mg/L for Berkeley Manor, and 13 mg/L for Watkins Village. By using this process, specific values for PCE, TCE, 1,2-tDCE, VC, and benzene concentrations in finished water distributed to the Holcomb Boulevard housing areas were computed and are

listed in Appendix S8.5 (Tables S8.5.1–S8.5.5, respectively) for each month, January 1972–December 1985. For selected months when concentrations are non-zero for any of the Holcomb Boulevard housing areas, a summary listing of Appendix S8.5 results is provided as Table S8.22. Note, of the five contaminants of concern to the ATSDR health studies (PCE, TCE, 1,2-tDCE, VC, and benzene), only TCE and VC exceed their current maximum contaminant levels (MCLs) (5 mg/L and 2 mg/L, respectively) in finished water distributed to Holcomb Boulevard family housing areas. This is due to low concentrations of PCE, 1,2-tDCE, and benzene in Hadnot Point finished water (Appendix A7) when it mixes with uncontaminated finished water in the Holcomb Boulevard water-distribution system. TCE is the predominant contaminant of concern for the Holcomb Boulevard housing area and exceeds the current MCL by factors of about 2–12 during intermittent water transfers occurring during the period July 1972–February 1985 (Table S8.22).

Spatial distributions of TCE within Holcomb Boulevard housing areas for three time periods—June 1978, May 1982, and February 1985—are shown in Figure S8.38. These historical reconstruction results were obtained using the EPANET 2 water-distribution system model previously discussed for interconnection events. The Holcomb Boulevard reconstructed finished-water mean TCE concentrations for the Berkeley Manor and Watkins Village housing areas during June 1978 are 51 mg/L and 38 mg/L, respectively.³² For May 1982, the Berkeley Manor and Watkins Village housing areas have reconstructed mean TCE concentrations of 20 mg/L and 13 mg/L, respectively. During the 8-day period of January 28–February 4, 1985 (represented by the February 1985 map in Figure S8.38), when the HBWTP was shut down, the reconstructed mean TCE concentrations in all housing areas exceeded 50 mg/L, with the exception of the northernmost extent of Paradise Point and a small area to the north of the Marston Pavilion valve. Overall, during intermittent transfers of contaminated Hadnot Point finished water, the Paradise Point family housing area has the lowest reconstructed mean TCE concentrations, whereas Berkeley Manor followed by Watkins Village have the greatest reconstructed mean TCE concentrations (except for the pipeline that directly connects booster pump 742 to the Holcomb Boulevard water-distribution system along Holcomb Boulevard). Spatial distribution maps (similar to Figure S8.38) for PCE, 1,2-tDCE, VC, and benzene are shown in Figures S8.39, S8.40, S8.41, and S8.42, respectively. Reconstructed mean concentrations for contaminants PCE, 1,2-tDCE, VC, and benzene rarely equaled or exceeded their current MCLs during interconnection periods of interest to the ATSDR health studies (Table S8.22).³³ Selected calibrated model input files for use with the EPANET 2 (Rossman 2000) model code representing the distribution of contaminants within the Holcomb Boulevard water-distribution system are provided on the CD-ROM that accompanies Chapter A.

³¹ Holcomb Boulevard housing areas and their designations for which results are provided are Paradise Point (PP), Midway Park (MP), Berkeley Manor (BM), and Watkins Village (WV); see Figure S8.3 for locations.

³² Refer also to Table S8.22 or Appendix Table S8.5.2.

³³ Current MCLs for PCE, TCE, and benzene are 5 µg/L; current MCL for 1,2-tDCE is 100 µg/L; current MCL for VC is 2 µg/L.

Table S8.21. Reconstructed (simulated) monthly mean percentage of finished Hadnot Point water treatment plant water transferred through booster pump 742 and distributed to Holcomb Boulevard family housing areas for occurrence of interconnection events, Hadnot Point–Holcomb Boulevard study area, U.S. Marine Corps Base Camp Lejeune, North Carolina, 1972–1985.^{1,2}

[PP, Paradise Point; MP, Midway Park; BM, Berkeley Manor; WV, Watkins Village; —, not applicable; HBWTP, Holcomb Boulevard water treatment plant]

| Month | 1972 | | | | 1973 | | | | 1974 | | | | 1975 | | | | 1976 | | | |
|-------|------|-----|-----|-----|------|----|----|-----|------|----|----|-----|-------|----|----|-----|------|----|----|-----|
| | PP | MP | BM | 4WV | PP | MP | BM | 4WV | PP | MP | BM | 4WV | PP | MP | BM | 4WV | PP | MP | BM | 4WV |
| Jan. | 100 | 100 | 100 | — | 0 | 0 | 0 | — | 0 | 0 | 0 | — | 0 | 0 | 0 | — | 0 | 0 | 0 | — |
| Feb. | 100 | 100 | 100 | — | 0 | 0 | 0 | — | 0 | 0 | 0 | — | 0 | 0 | 0 | — | 0 | 0 | 0 | — |
| Mar. | 100 | 100 | 100 | — | 0 | 0 | 0 | — | 0 | 0 | 0 | — | 0 | 0 | 0 | — | 0 | 0 | 0 | — |
| Apr. | 100 | 100 | 100 | — | 0 | 0 | 0 | — | 0 | 0 | 0 | — | 0 | 0 | 0 | — | 0 | 0 | 0 | — |
| May | 100 | 100 | 100 | — | 0 | 0 | 0 | — | 0 | 0 | 0 | — | 0 | 0 | 0 | — | 0 | 0 | 0 | — |
| June | 100 | 100 | 100 | — | 0 | 1 | 1 | — | 0 | 0 | 0 | — | 0 | 0 | 0 | — | 0 | 1 | 1 | — |
| July | 6 | 1 | 2 | — | 0 | 0 | 0 | — | 0 | 0 | 0 | — | 0 | 0 | 0 | — | 0 | 0 | 0 | — |
| Aug. | 0 | 0 | 0 | — | 0 | 0 | 0 | — | 0 | 0 | 0 | — | 0 | 0 | 0 | — | 0 | 0 | 0 | — |
| Sept. | 0 | 0 | 0 | — | 0 | 0 | 0 | — | 0 | 0 | 0 | — | 0 | 0 | 0 | — | 0 | 0 | 0 | — |
| Oct. | 0 | 0 | 0 | — | 0 | 0 | 0 | — | 0 | 0 | 0 | — | 0 | 0 | 0 | — | 0 | 0 | 0 | — |
| Nov. | 0 | 0 | 0 | — | 0 | 0 | 0 | — | 0 | 0 | 0 | — | 0 | 0 | 0 | — | 0 | 0 | 0 | — |
| Dec. | 0 | 0 | 0 | — | 0 | 0 | 0 | — | 0 | 0 | 0 | — | 0 | 0 | 0 | — | 0 | 0 | 0 | — |
| Month | 1977 | | | | 1978 | | | | 1979 | | | | 1980 | | | | 1981 | | | |
| | PP | MP | BM | 4WV | PP | MP | BM | 4WV | PP | MP | BM | WV | PP | MP | BM | WV | PP | MP | BM | WV |
| Jan. | 0 | 0 | 0 | — | 0 | 0 | 0 | 0 | 0 | 0 | 0 | 0 | 0 | 0 | 0 | 0 | 0 | 0 | 0 | 0 |
| Feb. | 0 | 0 | 0 | — | 0 | 0 | 0 | 0 | 0 | 0 | 0 | 0 | 0 | 0 | 0 | 0 | 0 | 0 | 0 | 0 |
| Mar. | 0 | 0 | 0 | — | 0 | 0 | 0 | 0 | 0 | 0 | 0 | 0 | 0 | 0 | 0 | 0 | 0 | 0 | 0 | 0 |
| Apr. | 0 | 1 | 1 | — | 0 | 0 | 0 | 0 | 0 | 1 | 1 | 1 | 0 | 0 | 0 | 0 | 0 | 1 | 15 | 11 |
| May | 0 | 0 | 1 | — | 0 | 1 | 2 | 1 | 0 | 0 | 1 | 1 | 0 | 0 | 0 | 0 | 0 | 1 | 4 | 3 |
| June | 0 | 0 | 1 | — | 1 | 7 | 15 | 11 | 0 | 1 | 2 | 1 | 0 | 2 | 4 | 3 | 0 | 1 | 3 | 2 |
| July | 0 | 1 | 1 | — | 0 | 0 | 0 | 0 | 0 | 0 | 1 | 1 | 0 | 0 | 0 | 0 | 0 | 0 | 1 | 1 |
| Aug. | 0 | 1 | 1 | — | 0 | 0 | 0 | 0 | 0 | 0 | 1 | 1 | 0 | 0 | 0 | 0 | 0 | 0 | 1 | 1 |
| Sept. | 0 | 0 | 0 | — | 0 | 0 | 0 | 0 | 0 | 0 | 0 | 0 | 0 | 0 | 0 | 0 | 0 | 0 | 0 | 0 |
| Oct. | 0 | 0 | 0 | — | 0 | 0 | 0 | 0 | 0 | 0 | 0 | 0 | 0 | 0 | 0 | 0 | 0 | 0 | 0 | 0 |
| Nov. | 0 | 0 | 0 | — | 0 | 0 | 0 | 0 | 0 | 0 | 0 | 0 | 0 | 0 | 0 | 0 | 0 | 0 | 0 | 0 |
| Dec. | 0 | 0 | 0 | — | 0 | 0 | 0 | 0 | 0 | 0 | 0 | 0 | 0 | 0 | 0 | 0 | 0 | 0 | 0 | 0 |
| Month | 1982 | | | | 1983 | | | | 1984 | | | | 51985 | | | | 1986 | | | |
| | PP | MP | BM | WV | PP | MP | BM | WV | PP | MP | BM | WV | PP | MP | BM | WV | PP | MP | BM | WV |
| Jan. | 0 | 0 | 0 | 0 | 0 | 0 | 0 | 0 | 0 | 0 | 0 | 0 | 10 | 10 | 10 | 10 | | | | |
| Feb. | 0 | 0 | 0 | 0 | 0 | 0 | 0 | 0 | 0 | 0 | 0 | 0 | 20 | 16 | 17 | 17 | | | | |
| Mar. | 0 | 0 | 0 | 0 | 0 | 0 | 0 | 0 | 0 | 0 | 0 | 0 | 0 | 0 | 0 | 0 | | | | |
| Apr. | 0 | 1 | 2 | 2 | 0 | 0 | 0 | 0 | 0 | 0 | 1 | 1 | 0 | 1 | 5 | 4 | | | | |
| May | 0 | 1 | 4 | 3 | 0 | 1 | 3 | 2 | 0 | 0 | 0 | 0 | 0 | 2 | 4 | 3 | | | | |
| June | 0 | 1 | 2 | 1 | 0 | 0 | 0 | 0 | 0 | 0 | 0 | 0 | 1 | 3 | 7 | 6 | | | | |
| July | 0 | 1 | 2 | 1 | 0 | 0 | 0 | 0 | 0 | 0 | 0 | 0 | 0 | 0 | 1 | 1 | | | | |
| Aug. | 0 | 0 | 1 | 1 | 0 | 0 | 1 | 1 | 0 | 0 | 0 | 0 | 3 | 1 | 1 | 1 | | | | |
| Sept. | 0 | 0 | 0 | 0 | 0 | 0 | 0 | 0 | 0 | 0 | 0 | 0 | 0 | 0 | 0 | 0 | | | | |
| Oct. | 0 | 0 | 0 | 0 | 0 | 0 | 0 | 0 | 0 | 0 | 0 | 0 | 0 | 0 | 0 | 0 | | | | |
| Nov. | 0 | 0 | 0 | 0 | 0 | 0 | 0 | 0 | 0 | 0 | 0 | 0 | 0 | 0 | 1 | 1 | | | | |
| Dec. | 0 | 0 | 0 | 0 | 0 | 0 | 0 | 0 | 0 | 0 | 0 | 0 | 0 | 0 | 0 | 0 | | | | |

¹Based on a concentration of 100 micrograms per liter of a dissolved conservative contaminant in Hadnot Point finished water being transferred through booster pump 742. To obtain a specific concentration for a Holcomb Boulevard family housing area, multiply the concentration of Hadnot Point finished water by percent (in decimal form) for month of interest

²Monthly percentages rounded to nearest whole number

³Values for January–June 1972 represent Hadnot Point finished water without any mixing (dilution) with HBWTP finished water because the HBWTP did not come online until after June 1972 (Scott A. Brewer, U.S. Marine Corps Base Camp Lejeune, written communication, September 29, 2005)

⁴Watkins Village housing was not built and occupied until about 1978 (Faye et al. 2010), and the first documented interconnection occurs during May 1978 (U.S. Marine Corps Base Camp Lejeune Water Documents CLW #7023, #7031, and #7033)

⁵For period of January 28–February 4, 1985, booster pump 742 operated continuously, and Marston Pavilion valve was open due to shutdown of HBWTP; this continuous event is not included in the Markov Chain analysis

Table S8.22. Reconstructed (simulated) mean concentrations of tetrachloroethylene (PCE), trichloroethylene (TCE), *trans*-1,2-dichloroethylene (1,2-tDCE), vinyl chloride (VC), and benzene in finished water distributed to Holcomb Boulevard family housing areas for selected months, Hadnot Point–Holcomb Boulevard study area, U.S. Marine Corps Base Camp Lejeune, North Carolina, 1972–1985.^{1,2}

[µg/L, microgram per liter; PP, Paradise Point; MP, Midway Park; BM, Berkeley Manor; WV, Watkins Village; —, not applicable; HBWTP, Holcomb Boulevard water treatment plant]

| Month Year | Concentration, in µg/L | | | | Month Year | Concentration, in µg/L | | | | Month Year | Concentration, in µg/L | | | |
|---|------------------------|----|----|-----------------|---------------|------------------------|----|----|-----------------|------------------------|------------------------|----|----|-----------------|
| | PP | MP | BM | ³ WV | | PP | MP | BM | ³ WV | | PP | MP | BM | ³ WV |
| Tetrachloroethylene (PCE)⁴ | | | | | | | | | | | | | | |
| June 1978 | 0 | 1 | 2 | 2 | May 1982 | 0 | 0 | 1 | 1 | Jan. 1985 ⁵ | 2 | 2 | 2 | 2 |
| June 1980 | 0 | 0 | 1 | 1 | June 1982 | 0 | 0 | 1 | 0 | Feb. 1985 ⁵ | 3 | 3 | 3 | 3 |
| Apr. 1981 | 0 | 0 | 2 | 1 | July 1982 | 0 | 0 | 1 | 0 | | | | | |
| May 1981 | 0 | 0 | 1 | 0 | May 1983 | 0 | 0 | 1 | 0 | | | | | |
| Trichloroethylene (TCE)⁴ | | | | | | | | | | | | | | |
| Jan. 1972 | 22 | 22 | 22 | — | May 1978 | 0 | 2 | 6 | 4 | Apr. 1982 | 0 | 3 | 9 | 7 |
| Feb. 1972 | 21 | 21 | 21 | — | June 1978 | 3 | 23 | 51 | 38 | May 1982 | 1 | 6 | 20 | 13 |
| Mar. 1972 | 17 | 17 | 17 | — | July 1978 | 0 | 0 | 1 | 1 | June 1982 | 0 | 4 | 10 | 7 |
| Apr. 1972 | 24 | 24 | 24 | — | Apr. 1979 | 0 | 1 | 2 | 1 | July 1982 | 0 | 4 | 12 | 8 |
| May 1972 | 19 | 19 | 19 | — | May 1979 | 0 | 1 | 3 | 2 | Aug. 1982 | 1 | 3 | 6 | 4 |
| June 1972 | 19 | 19 | 19 | — | June 1979 | 0 | 2 | 6 | 4 | May 1983 | 1 | 5 | 14 | 10 |
| July 1972 | 1 | 0 | 0 | — | July 1979 | 0 | 1 | 4 | 2 | June 1983 | 0 | 0 | 2 | 2 |
| June 1973 | 0 | 0 | 1 | — | Aug. 1979 | 0 | 2 | 5 | 3 | July 1983 | 0 | 0 | 3 | 2 |
| June 1976 | 1 | 2 | 3 | — | June 1980 | 2 | 8 | 17 | 13 | Aug. 1983 | 0 | 2 | 5 | 3 |
| Apr. 1977 | 0 | 1 | 2 | — | Apr. 1981 | 0 | 4 | 39 | 28 | Apr. 1984 | 0 | 2 | 5 | 3 |
| May 1977 | 1 | 1 | 3 | — | May 1981 | 0 | 4 | 13 | 10 | Jan. 1985 ⁵ | 34 | 31 | 32 | 34 |
| June 1977 | 1 | 2 | 3 | — | June 1981 | 0 | 4 | 10 | 7 | Feb. 1985 ⁵ | 66 | 53 | 54 | 56 |
| July 1977 | 1 | 2 | 3 | — | July 1981 | 0 | 2 | 4 | 3 | | | | | |
| Aug. 1977 | 1 | 2 | 4 | — | Aug. 1981 | 0 | 2 | 6 | 4 | | | | | |
| <i>Trans</i>-1,2-dichloroethylene (1,2-tDCE)⁴ | | | | | | | | | | | | | | |
| June 1973 | 0 | 1 | 1 | — | June 1979 | 0 | 1 | 3 | 2 | June 1982 | 0 | 2 | 6 | 4 |
| June 1976 | 0 | 1 | 2 | — | July 1979 | 0 | 0 | 1 | 1 | July 1982 | 0 | 2 | 6 | 4 |
| Apr. 1977 | 0 | 1 | 1 | — | Aug. 1979 | 0 | 1 | 2 | 1 | Aug. 1982 | 0 | 2 | 3 | 2 |
| May 1977 | 0 | 1 | 1 | — | June 1980 | 1 | 3 | 7 | 5 | May 1983 | 0 | 3 | 8 | 5 |
| June 1977 | 0 | 1 | 1 | — | Apr. 1981 | 0 | 2 | 16 | 12 | June 1983 | 0 | 0 | 1 | 1 |
| July 1977 | 0 | 1 | 2 | — | May 1981 | 0 | 2 | 6 | 4 | July 1983 | 0 | 0 | 2 | 1 |
| Aug. 1977 | 0 | 1 | 2 | — | June 1981 | 0 | 2 | 4 | 3 | Aug. 1983 | 0 | 1 | 3 | 2 |
| May 1978 | 0 | 1 | 3 | 2 | July 1981 | 0 | 1 | 2 | 1 | Apr. 1984 | 0 | 1 | 2 | 2 |
| June 1978 | 2 | 10 | 22 | 17 | Aug. 1981 | 0 | 1 | 3 | 2 | Jan. 1985 ⁵ | 17 | 16 | 16 | 17 |
| Apr. 1979 | 0 | 1 | 1 | 1 | Apr. 1982 | 0 | 2 | 4 | 3 | Feb. 1985 ⁵ | 33 | 27 | 27 | 27 |
| May 1979 | 0 | 0 | 1 | 1 | May 1982 | 0 | 3 | 10 | 7 | | | | | |
| Vinyl chloride (VC)⁴ | | | | | | | | | | | | | | |
| June 1978 | 0 | 1 | 3 | 2 | June 1981 | 0 | 0 | 1 | 0 | July 1982 | 0 | 0 | 1 | 1 |
| June 1980 | 0 | 1 | 1 | 1 | Apr. 1982 | 0 | 0 | 1 | 0 | May 1983 | 0 | 0 | 1 | 1 |
| Apr. 1981 | 0 | 0 | 3 | 2 | May 1982 | 0 | 0 | 1 | 1 | Jan. 1985 ⁵ | 3 | 3 | 3 | 3 |
| May 1981 | 0 | 0 | 1 | 1 | June 1982 | 0 | 0 | 1 | 1 | Feb. 1985 ⁵ | 6 | 5 | 5 | 5 |
| Benzene⁴ | | | | | | | | | | | | | | |
| Jan. 1972 | 3 | 3 | 3 | — | Apr. 1972 | 3 | 3 | 3 | — | June 1978 | 0 | 0 | 1 | 0 |
| Feb. 1972 | 3 | 3 | 3 | — | May 1972 | 3 | 3 | 3 | — | Apr. 1981 | 0 | 0 | 1 | 1 |
| Mar. 1972 | 2 | 2 | 2 | — | June 1972 | 3 | 3 | 3 | — | Feb. 1985 ⁵ | 1 | 1 | 1 | 1 |

¹ See Appendix S8.5 (Tables S8.5.1–S8.5.5) for complete monthly listing, January 1972–December 1985

² Values for January–June 1972 represent Hadnot Point finished water without any mixing (dilution) with HBWTP finished water because the HBWTP did not come online until after June 1972 (Scott A. Brewer, U.S. Marine Corps Base Camp Lejeune, written communication, September 29, 2005)

³ Watkins Village housing was not built and occupied until about 1978 (Faye et al. 2010), and the first documented interconnection occurs during May 1978 (U.S. Marine Corps Base Camp Lejeune Water Documents CLW #7023, #7031, and #7033)

⁴ Current maximum contaminant level (MCL) for PCE, TCE, and benzene is 5 µg/L; current MCL for 1,2-tDCE is 100 µg/L; current MCL for VC is 2 µg/L

⁵ For the 8-day period January 27–February 4, 1985, the HBWTP was shut down, and contaminated Hadnot Point finished water was continuously provided to Holcomb Boulevard family housing areas

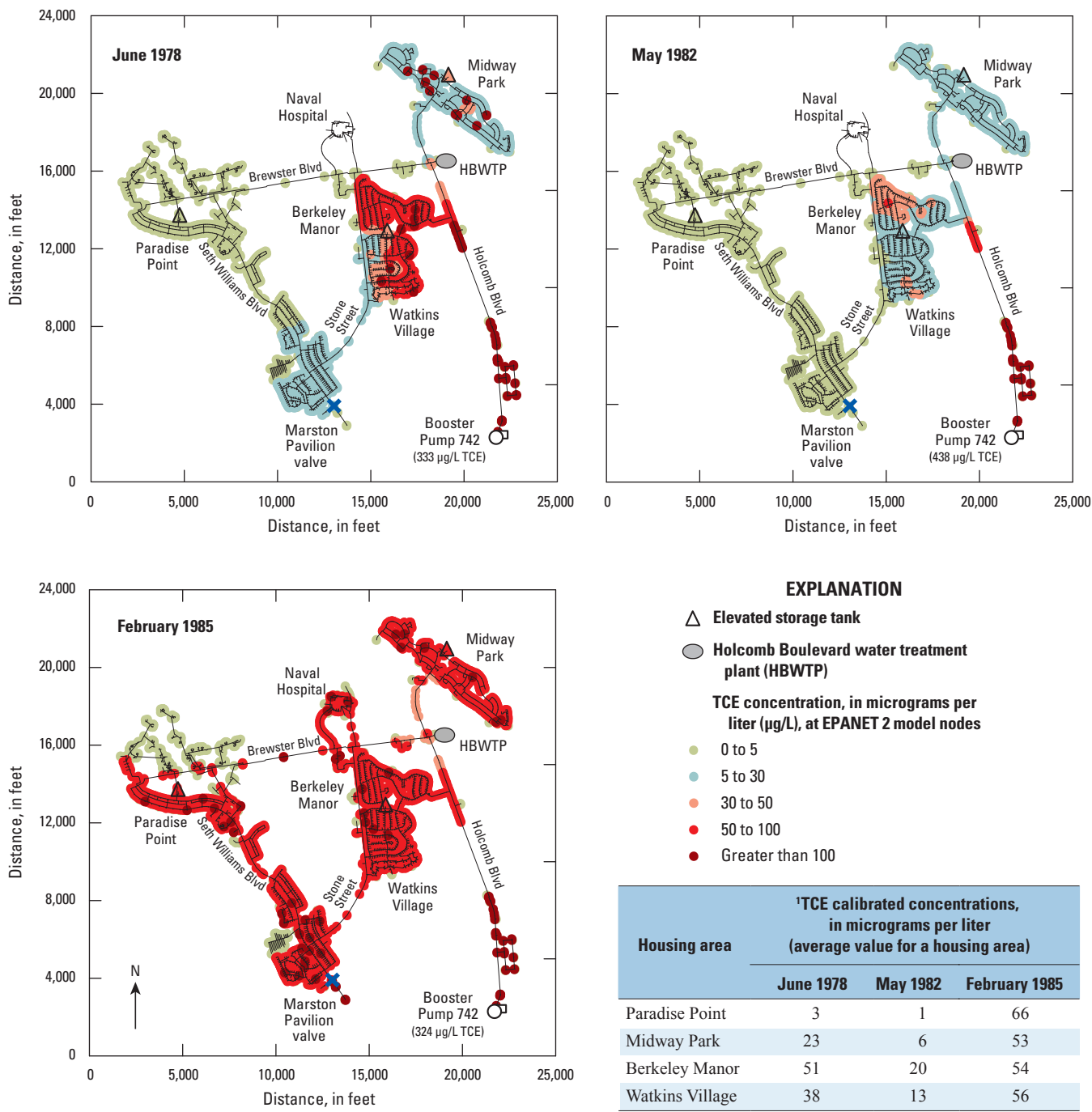

Figure S8.38. Reconstructed (simulated) distribution of trichloroethylene (TCE) contamination within the Holcomb Boulevard water treatment plant service area resulting from supply of contaminated Hadnot Point finished water, Hadnot Point–Holcomb Boulevard study area, U.S. Marine Corps Base Camp Lejeune, North Carolina, June 1978, May 1982, and February 1985. See Figure S8.1 for location.

¹Calibrated values derived from a single deterministic simulation; maximum contaminant level for TCE is 5 micrograms per liter

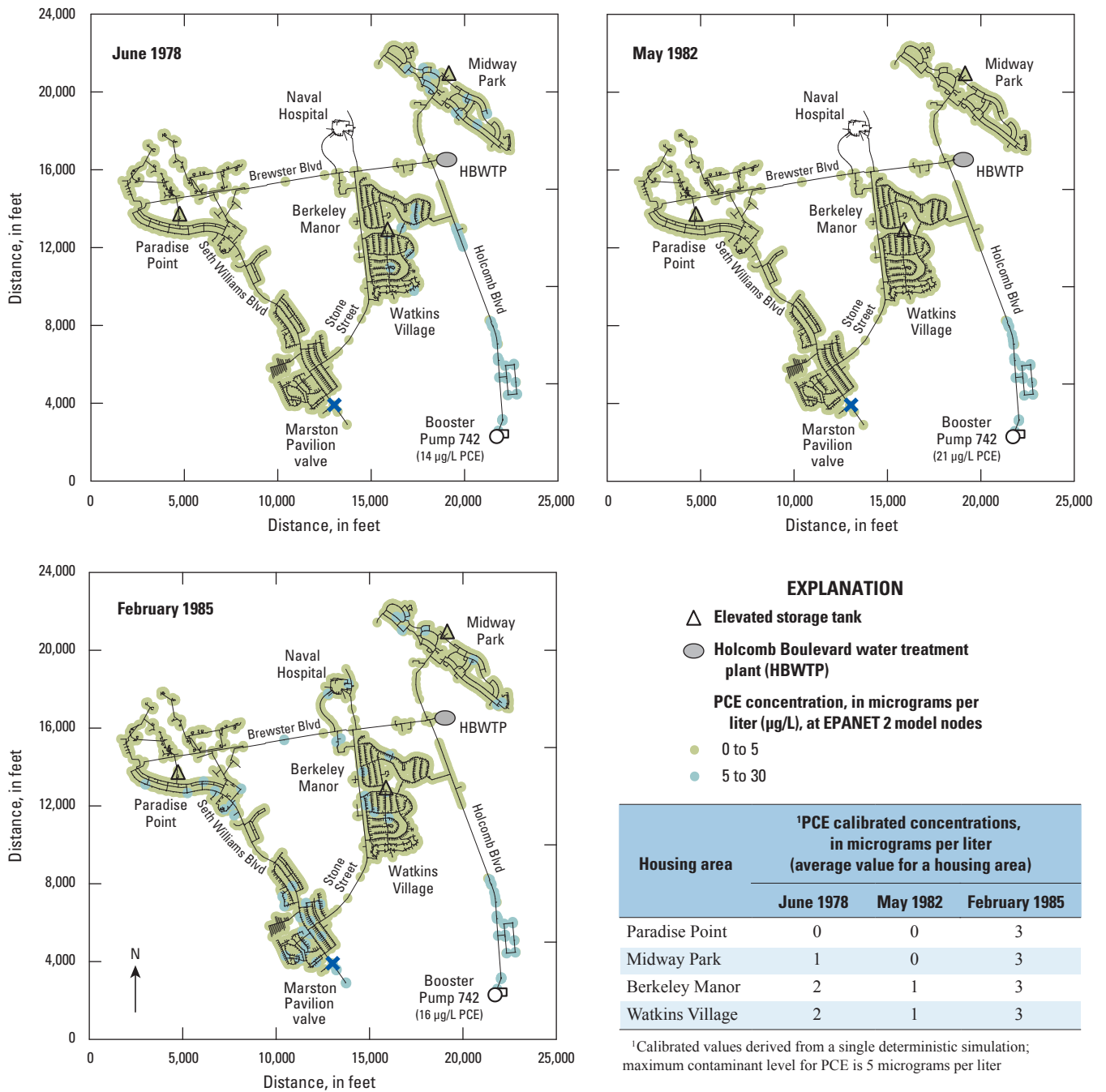

Figure S8.39. Reconstructed (simulated) distribution of tetrachloroethylene (PCE) contamination within the Holcomb Boulevard water treatment plant service area resulting from supply of contaminated Hadnot Point finished water, Hadnot Point–Holcomb Boulevard study area, U.S. Marine Corps Base Camp Lejeune, North Carolina, June 1978, May 1982, and February 1985. See Figure S8.1 for location.

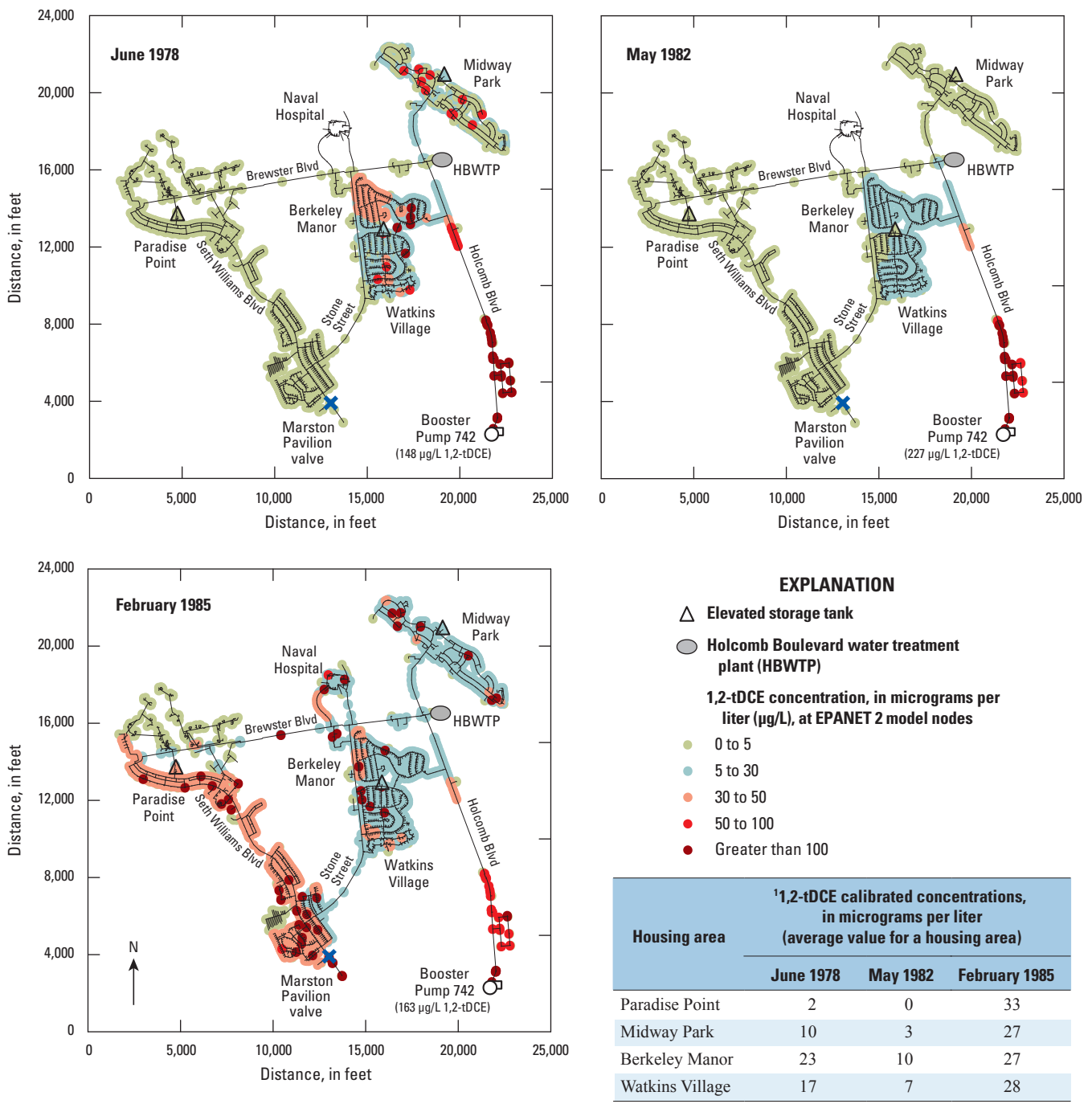

Figure S8.40. Reconstructed (simulated) distribution of *trans*-1,2-dichloroethylene (1,2-tDCE) contamination within the Holcomb Boulevard water treatment plant service area resulting from supply of contaminated Hadnot Point finished water, Hadnot Point–Holcomb Boulevard study area, U.S. Marine Corps Base Camp Lejeune, North Carolina, June 1978, May 1982, and February 1985. See Figure S8.1 for location.

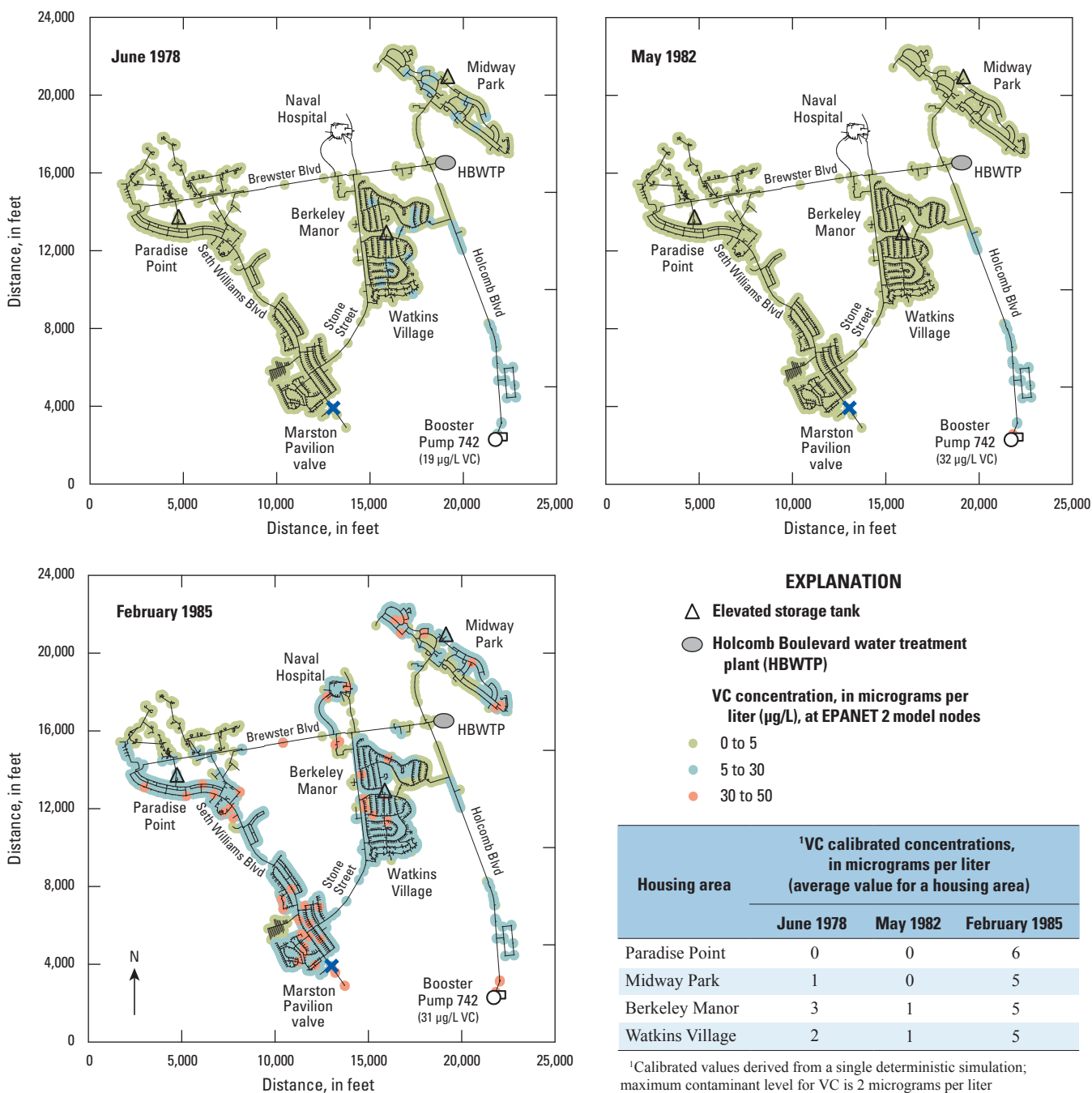

Figure S8.41. Reconstructed (simulated) distribution of vinyl chloride (VC) contamination within the Holcomb Boulevard water treatment plant service area resulting from supply of contaminated Hadnot Point finished water, Hadnot Point–Holcomb Boulevard study area, U.S. Marine Corps Base Camp Lejeune, North Carolina, June 1978, May 1982, and February 1985. See Figure S8.1 for location.

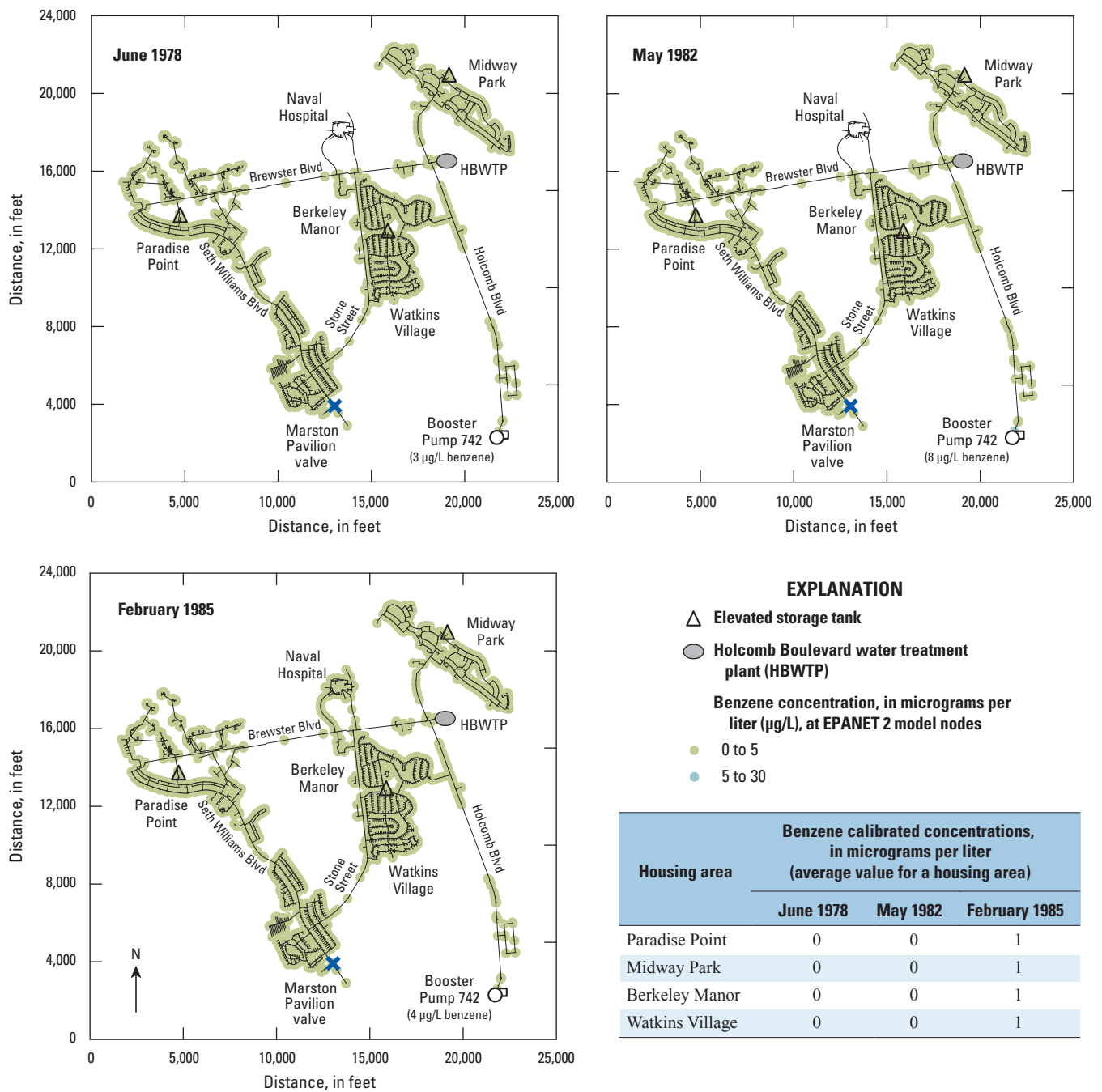

Figure S8.42. Reconstructed (simulated) distribution of benzene contamination within the Holcomb Boulevard water treatment plant service area resulting from supply of contaminated Hadnot Point finished water, Hadnot Point–Holcomb Boulevard study area, U.S. Marine Corps Base Camp Lejeune, North Carolina, June 1978, May 1982, and February 1985. See Figure S8.1 for location.

Model Sensitivity and Uncertainty

Best modeling practice requires that evaluations be conducted to ascertain confidence in models and model results by assessing parameter sensitivity, variance, and uncertainty associated with the modeling process and with the outcomes attributed to models (ASTM 1994; Saltelli et al. 2000). There are numerous methods for characterizing a model's sensitivity and uncertainty based on variations of calibrated parameter values (ASTM 1994; Cullen and Frey 1999; Saltelli et al. 2000; Tung and Yen 2005; Hill and Tiedeman 2007). These methods are generally classified into two groups: (1) sensitivity analysis, wherein calibrated model parameter values are varied one at a time (either manually or through some automated and objective parameter estimation method) and (2) probabilistic uncertainty analysis, wherein probabilistic methods are used to characterize and quantify the input and output parameter variation and uncertainty.³⁴

Sensitivity Analysis

For the water-distribution system models described herein, three types of sensitivity analyses were conducted: (1) storage tank mixing models, (2) Hazen-Williams roughness coefficient (C-factor), and (3) demand-pattern factor. All of these sensitivity analyses are described in substantial detail in Maslia et al. (2009) and are summarized below.

A series of sensitivity analyses were conducted to assess the effect of using different storage tank simple mixing models available with EPANET 2 (CSTR, 2-COMP, FIFO, and LIFO). As previously discussed in the report section on Hydraulic and Water-Quality Model Calibrations—Holcomb Boulevard, the default uniform mixing or CSTR tank model was determined not to be the best fit for calibration, and the LIFO plug-flow tank mixing model was determined to be the best fit for calibration of simulated concentration results (Figures S8.27–S8.30).

The PEST code (Doherty 2003, 2010) was used to conduct automated and objective sensitivity analyses for C-factor and demand patterns. The objective function minimized by PEST was the sum of squared differences between measured and simulated storage tank hydraulic head. For these sensitivity analyses, both the Holcomb Boulevard and Tarawa Terrace water-distribution system network models were used because for 2004 conditions, the HBWTP provided finished water for both of the aforementioned water-distribution systems. Results of the PEST sensitivity analysis for C-factor indicated that the water-distribution system models are relatively insensitive to C-factor variation and that C-factor variation for PVC pipe material is about an order of magnitude more sensitive than for variation of cast iron pipe material (Maslia et al. 2009).

³⁴ Probabilistic uncertainty analysis is described and discussed in the Uncertainty Analysis section of this report.

Sensitivity analysis on demand-pattern factors compared model results (storage tank hydraulic heads) using water-balance analysis and PEST-derived demand factors. Overall, results showed that the PEST-derived demand factors provided closer agreement (minimized sum of squares for hydraulic head difference) between measured and simulated hydraulic head than demand-factor patterns derived using the water-balance analysis (Maslia et al. 2009). Additional discussion is also provided in this supplement report section on Hydraulic and Water-Quality Model Calibrations—Holcomb Boulevard.

Uncertainty Analysis

Variability and uncertainty are inherent features of the data, analyses, models, and calibrated model parameters described in detail in other HPHB supplemental information reports and in the Chapter A report. The purpose of this report section is to summarize the characterization of uncertainty of model output (e.g., simulated concentrations) due to model input parameter uncertainty and variability. Numerous methods are described in the literature for conducting uncertainty analyses (Cullen and Frey 1999; Saltelli et al. 2000; Tung and Yen 2005; Hill and Tiedeman 2007). Within the generalized classification of uncertainty analysis, Monte Carlo (MC) simulation is a particularly well-known numerical method (USEPA 1997; Tung and Yen 2005). To evaluate uncertainty associated with modeling analyses of the transfer of finished water from Hadnot Point to Holcomb Boulevard, selected probabilistic analyses using MC simulation were conducted. These analyses and evaluations of MC simulation results are described below.

For the periods of finished-water transfers from Hadnot Point to the Holcomb Boulevard water-distribution system, MC simulation realizations were generated by using the parameter estimation code PEST (Doherty 2003, 2010). MC simulations consisted of 1,000 realizations and assumed a normal distribution for parameter variants. As demonstrated in Maslia et al. (2009), the Holcomb Boulevard water-distribution system is insensitive to variation in pipe roughness coefficient (C-factor), which is a parameter that affects pressures (and resulting hydraulic heads) in water-distribution system pipelines. Therefore, the parameter that was varied for calibration purposes was nodal demand. Uncertainty of this parameter was assessed by using a probabilistic analysis for simulating water-transfer events. PEST allowed for the 24-hour demand patterns within each of the 34 EPANET 2 models to vary, assuming a normal distribution. By allowing the demand patterns to vary within each model, the overall amount of monthly finished water delivered by the HBWTP (Table S8.19) was varied by as much as $\pm 25\%$ within each realization of the MC simulations. Results for variation in TCE concentrations at five demand locations within Holcomb Boulevard family housing areas are shown in Figure S8.43. Results are provided for two Paradise Point locations (a northern and southern location on Seth Williams Boulevard),

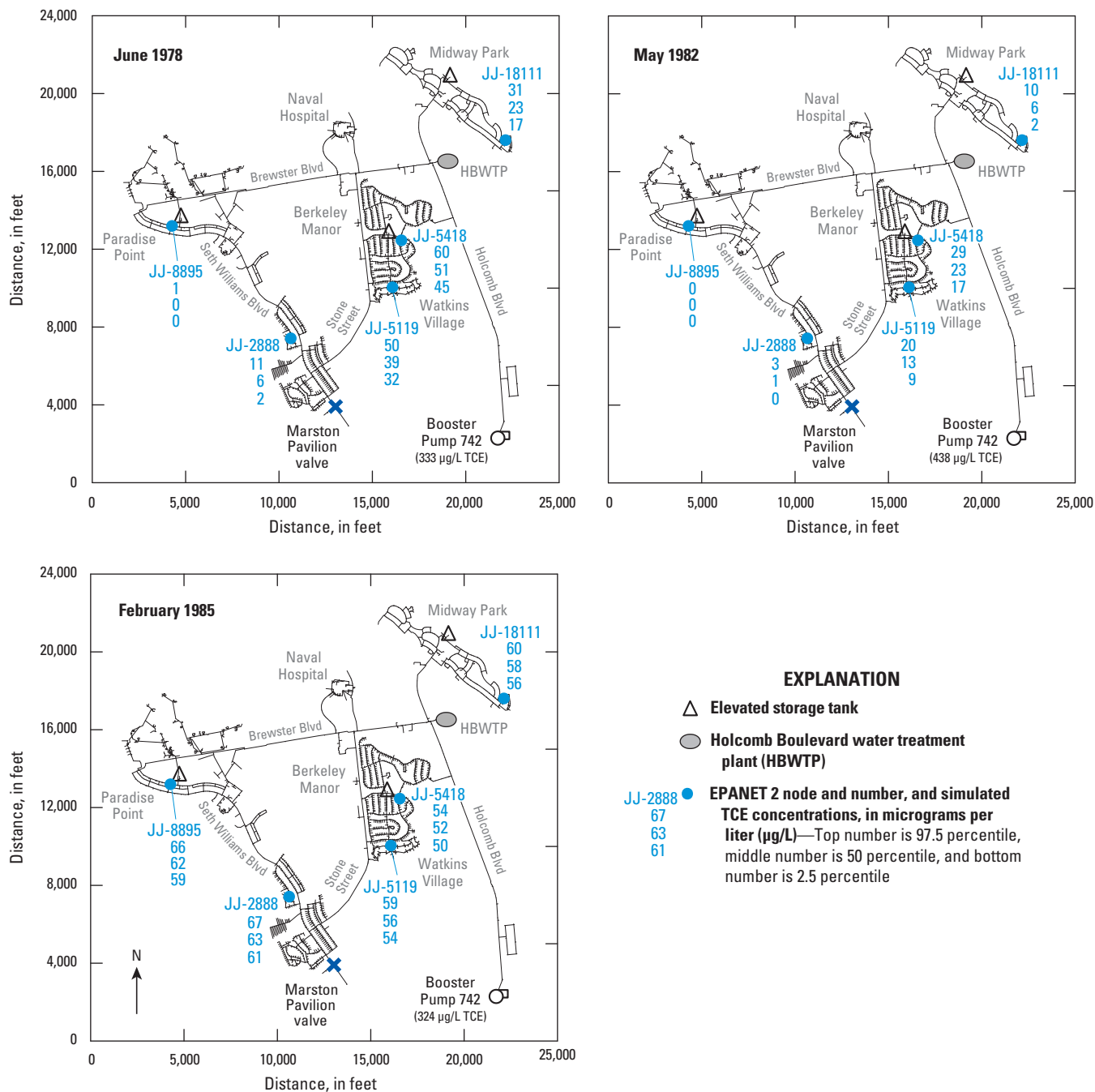

Figure S8.43. Variations in reconstructed (simulated) concentrations of trichloroethylene (TCE) contamination at selected locations within the Holcomb Boulevard water treatment plant service area resulting from supply of contaminated Hadnot Point finished water, Hadnot Point–Holcomb Boulevard study area, U.S. Marine Corps Base Camp Lejeune, North Carolina, June 1978, May 1982, and February 1985.

and one location each for Berkeley Manor, Watkins Village, and Midway Park. For the locations shown, the top number is the maximum (97.5 percentile) concentration, the middle number is the median (50 percentile) concentration, and the lower number is the minimum (2.5 percentile) concentration that resulted from applying an MC simulation to the water-transfer events shown in Figure S8.37.

Probabilistic analysis results for reconstructed TCE finished-water concentrations are also listed in Tables S8.23 and S8.24. Table S8.23 provides results that were averaged over an entire housing area (e.g., Watkins Village), whereas Table S8.24 lists MC simulation results for the specific locations in housing areas shown in Figure S8.43. MC simulation results listed in Tables S8.23 and S8.24 are provided for the 2.5 percentile ($P_{2.5}$), 50 percentile (P_{50}), and 97.5 percentile ($P_{97.5}$) values. Because a normal distribution was assumed, the P_{50} values should be nearly the same as the calibrated monthly mean

finished-water concentrations (deterministic values); results listed in Tables S8.23 and S8.24 confirm this observation.

Results listed in Table S8.23 can be interpreted as follows. For a Holcomb Boulevard housing area (e.g., Watkins Village), 95 percent of the MC simulated TCE finished-water concentrations will be between the $P_{97.5}$ percentile and the $P_{2.5}$ percentile values. For example, for June 1978 for the Watkins Village housing area, 95 percent of MC simulated TCE finished-water concentrations will be in the range of 32 $\mu\text{g/L}$ to 48 $\mu\text{g/L}$. For February 1985 for the Paradise Point housing area, 95 percent of MC simulated TCE finished-water concentrations will be in the range of 62 $\mu\text{g/L}$ to 70 $\mu\text{g/L}$. The probabilistic results listed in Table S8.23 indicate small variations (factors of 1 or less) in finished-water concentrations for TCE and that the probabilistically determined monthly mean concentrations (P_{50} values) are nearly identical to the calibrated monthly mean concentrations (deterministically determined).

Table S8.23. Reconstructed (simulated) trichloroethylene (TCE) concentrations in finished water distributed to Holcomb Boulevard family housing areas derived from probabilistic analysis using Monte Carlo simulation, Hadnot Point–Holcomb Boulevard study area, U.S. Marine Corps Base Camp Lejeune, North Carolina, June 1978, May 1982, and February 1985.

| Housing area | Reconstructed TCE concentration, in micrograms per liter | | | |
|-----------------|--|------------------------------------|----------|------------|
| | Calibrated ¹ | Monte Carlo simulated ² | | |
| | Mean | $P_{2.5}$ | P_{50} | $P_{97.5}$ |
| June 1978 | | | | |
| Paradise Point | 3 | 2 | 4 | 8 |
| Midway Park | 23 | 18 | 23 | 30 |
| Berkeley Manor | 51 | 44 | 49 | 59 |
| Watkins Village | 38 | 32 | 38 | 48 |
| May 1982 | | | | |
| Paradise Point | 1 | 0 | 1 | 2 |
| Midway Park | 6 | 2 | 6 | 9 |
| Berkeley Manor | 20 | 17 | 20 | 25 |
| Watkins Village | 13 | 11 | 14 | 19 |
| February 1985 | | | | |
| Paradise Point | 66 | 62 | 65 | 70 |
| Midway Park | 53 | 52 | 53 | 55 |
| Berkeley Manor | 54 | 53 | 55 | 57 |
| Watkins Village | 56 | 54 | 56 | 59 |

¹ Calibrated values derived from a single deterministic simulation

² Monte Carlo simulated values generated using PEST (Doherty 2003, 2010) consist of 1,000 realizations using normal distribution; $P_{2.5}$, 2.5 percentile; P_{50} , 50 percentile; $P_{97.5}$, 97.5 percentile

Table S8.24. Reconstructed (simulated) trichloroethylene (TCE) concentrations in finished water at selected locations within Holcomb Boulevard family housing areas derived from probabilistic analysis using Monte Carlo simulation, Hadnot Point–Holcomb Boulevard study area, U.S. Marine Corps Base Camp Lejeune, North Carolina, June 1978, May 1982, and February 1985.

| Housing area | Selected node number ¹ | Reconstructed TCE concentration, in micrograms per liter | | | |
|-----------------|-----------------------------------|--|------------------------------------|----------|------------|
| | | Calibrated ² | Monte Carlo simulated ³ | | |
| | | Mean | $P_{2.5}$ | P_{50} | $P_{97.5}$ |
| June 1978 | | | | | |
| Paradise Point | JJ-2888 | 6 | 2 | 6 | 11 |
| Paradise Point | JJ-8895 | 0 | 0 | 0 | 1 |
| Midway Park | JJ-18111 | 23 | 17 | 23 | 31 |
| Berkeley Manor | JJ-5418 | 49 | 45 | 51 | 60 |
| Watkins Village | JJ-5119 | 36 | 32 | 39 | 50 |
| May 1982 | | | | | |
| Paradise Point | JJ-2888 | 1 | 0 | 1 | 3 |
| Paradise Point | JJ-8895 | 0 | 0 | 0 | 0 |
| Midway Park | JJ-18111 | 6 | 2 | 6 | 10 |
| Berkeley Manor | JJ-5418 | 24 | 17 | 23 | 29 |
| Watkins Village | JJ-5119 | 12 | 9 | 13 | 20 |
| February 1985 | | | | | |
| Paradise Point | JJ-2888 | 63 | 61 | 63 | 67 |
| Paradise Point | JJ-8895 | 61 | 59 | 62 | 66 |
| Midway Park | JJ-18111 | 57 | 56 | 58 | 60 |
| Berkeley Manor | JJ-5418 | 52 | 50 | 52 | 54 |
| Watkins Village | JJ-5119 | 55 | 54 | 56 | 59 |

¹ See Figure A42; node references EPANET 2 model input file

² Calibrated values derived from a single deterministic simulation

³ Monte Carlo simulated values generated using PEST (Doherty 2003, 2010) consist of 1,000 realizations using normal distribution; $P_{2.5}$, 2.5 percentile; P_{50} , 50 percentile; $P_{97.5}$, 97.5 percentile

Probabilistic concentration distributions at selected model nodes and housing areas (Figure S8.43 and Table S8.24) indicate ranges of factors of about 2 to 3 for a 95-percentile range (97.5 percentile–2.5 percentile) for most locations (e.g., Midway Park for June 1978, Paradise Point for May 1982, and Watkins Village for February 1985). For example, referring to Table S8.24, for Midway Park for June 1978, the 97.5-percentile ($P_{97.5}$) TCE concentration value is 31 $\mu\text{g/L}$, and the 2.5-percentile ($P_{2.5}$) TCE concentration value is 17 $\mu\text{g/L}$, which is a range of about a factor of 2. For the 8-day period of January 28–February 4, 1985, when the HBWTP was shut down and all finished water was supplied by the HPWTP (represented by February 1985 in Figure S8.43 and Table S8.24), TCE concentrations at the selected Holcomb Boulevard housing locations derived from the MC simulations vary from 50 $\mu\text{g/L}$ (Berkeley Manor, node JJ-5418) to 67 $\mu\text{g/L}$ (Paradise Point, node JJ-2888). For the 8-day period of January 28–February 4, 1985, represented by February 1985 results listed in Tables S8.23 and S8.24, variations in concentrations are relatively small. This may be indicative that finished water within the Holcomb Boulevard water-distribution system during the period January 28–February 4, 1985, was uniformly mixed with contaminated Hadnot Point finished water. MC simulation results for selected months of water transfer for PCE, TCE, 1,2-tDCE, VC, and benzene during the period January 1972–December 1985 when concentrations are non-zero are listed in Appendix S8.6 (Tables S8.6.1–S8.6.5, respectively).

Discussion

To estimate historical concentrations in finished water within the Holcomb Boulevard housing area, water-distribution system analyses were undertaken, including the calibration and application of a numerical water-distribution system model. An assumption was made that 2004 characteristics and conditions were sufficiently similar to historical characteristics and conditions so as to be able to use 2004 water-distribution system conditions for historical reconstruction purposes. Similar assumptions have been successfully used in other historical reconstructions of water-distribution systems by Maslia et al. (2000, 2001, 2005). To assist with calibrating the Holcomb Boulevard water-distribution system model, field tests were conducted during 2004. Field data collected during the tests included pressures, water levels in storage tanks, Hazen-Williams C-factors, and water-quality samples of fluoride. Fluoride monitoring was accomplished by shutting off the NaF feed at the HBWTP and monitoring the dilution and reinjection of NaF during a September 22–October 12, 2004, field test. Fluoride data were collected using continuous recording water-quality data logging equipment and grab samples, which were split and analyzed at two different water-quality laboratories (HBWTP and the FOH water-quality laboratories).

Calibrating the model of the 2004 Holcomb Boulevard water-distribution system and conducting sensitivity analyses indicated that the most sensitive model parameter was nodal demand. Because individual household and other facility water usage is not metered at USMCB, this model parameter is most likely the parameter of greatest uncertainty and variability. In conjunction with nodal demand uncertainty are missing data and information on interconnection events—occurring when contaminated Hadnot Point finished water was transferred to the Holcomb Boulevard water-distribution system during 1972–1985 (Figure S8.37). To overcome this issue, a Markov analysis was applied to probabilistically estimate the occurrence of interconnection events.

To assess uncertainty and variability associated with nodal demand, a probabilistic uncertainty analysis using MC simulation was conducted by varying nodal demand by as much as $\pm 25\%$ within each of the 1,000 MC realizations. For TCE contamination, results of the probabilistic uncertainty analyses indicated a variation in concentration range of a factor of about 2 to 3. Considering other system uncertainties and the lack of household-specific water-usage metering, this variation is well within acceptable limits required by the ATSDR epidemiological studies.

Summary and Conclusions

The Agency for Toxic Substances and Disease Registry (ATSDR) is conducting epidemiological studies to evaluate exposures to volatile organic compounds (VOCs) such as tetrachloroethylene (PCE), trichloroethylene (TCE), *trans*-1,2-dichloroethylene (1,2-tDCE), vinyl chloride (VC), and benzene in finished water at U.S. Marine Corps Base (USMCB) Camp Lejeune, North Carolina. To obtain estimates of historical exposure, the ATSDR is using water-modeling techniques and the process of historical reconstruction to quantify concentrations of particular contaminants in finished water and to compute the level and duration of human exposure to contaminated finished water.

Using information and data gathered during the field tests, along with data provided by Camp Lejeune utility staff, an extended period simulation (EPS) model for water-distribution system hydraulics and water-quality dynamics was developed and calibrated using EPANET 2 (Rossman 2000). The calibrated EPANET 2 model of the Holcomb Boulevard water-distribution system was used in conjunction with Markov Chain analysis to estimate the concentrations of VOCs during 1972–1985. During this time, contaminated finished water was intermittently provided to the Holcomb Boulevard housing areas from the Hadnot Point water-distribution system. Based on information sources, field data, modeling analyses and results, and the historical reconstruction process, subsequent to June 1972 when the HBWTP came online to service this housing area, the interconnection analysis indicates that the maximum reconstructed (simulated) TCE concentration in finished water for the Holcomb Boulevard housing area water was 66 µg/L during February 1985. The maximum reconstructed (simulated) monthly concentrations for PCE, 1,2-tDCE, and VC in finished water for the Holcomb Boulevard housing area occurred during February 1985 and were 3 µg/L, 33 µg/L, and 6 µg/L, respectively. The maximum reconstructed (simulated) monthly concentration for benzene was 3 µg/L, which occurred during January, February, April, May, and June 1972 (Table S8.22). Thus, TCE is the predominant contaminant of concern for the Holcomb Boulevard housing area and exceeds the current MCL by a factor of about 5–10. This exceedance occurs during the period when the HBWTP was shut down—January 28–February 4, 1985. Reconstructed concentrations for contaminants PCE, 1,2-tDCE, VC, and benzene rarely equaled or exceeded their current MCLs during interconnection periods of interest to the ATSDR health studies.

References

- AH Environmental Consultants. Long Term Water System Master Plan—Draft Plan, Marine Corps Base, Camp Lejeune. Norfolk, VA: Naval Facilities Engineering Command, Atlantic Division; 2001. Contract No.: N62470-00-D-3300, Delivery Order 0011.
- ASTM. Standard Guide for Conducting a Sensitivity Analysis for a Ground-Water Flow Model Application. ASTM Guide D5611-94 (Reapproved 2002). West Conshohocken, PA: ASTM; 1994.
- AWWA Engineering Computer Applications Committee. Calibration Guidelines for Water Distribution System Modeling. Proceedings: AWWA Information Management and Technology Conference (IMTech); 1999 April; New Orleans, LA. New York: American Water Works Association; 1999.
- Cesario L. Modeling, Analysis, and Design of Water Distribution Systems. Denver, CO: American Water Works Association; 1995.
- Clark RM, and Grayman WM. Modeling Water Quality in Drinking Water Distribution Systems. Denver, CO: American Water Works Association; 1998.
- CLHDW CDR, Camp Lejeune Historic Drinking Water Consolidated Document Repository, 1199–10257 (not consecutively numbered), provided on electronic media to ATSDR, For Official Use Only (FOUO) documents. U.S. Marine Corps Base Camp Lejeune, Environmental Management Division; March 2011.
- CLW, Camp Lejeune Water Documents, 0001–8761 (not consecutively available), provided on CD-ROM format. In: Maslia ML, Sautner JB, Faye RE, Suárez-Soto RJ, Aral MM, Grayman WM, Jang W, Wang J, Bove FJ, Ruckart PZ, Valenzuela C, Green JW Jr, and Krueger AL. Analyses of Groundwater Flow, Contaminant Fate and Transport, and Distribution of Drinking Water at Tarawa Terrace and Vicinity, U.S. Marine Corps Base Camp Lejeune, North Carolina: Historical Reconstruction and Present-Day Conditions—Chapter A: Summary of Findings. Atlanta, GA: Agency for Toxic Substances and Disease Registry; 2007.

References

- Cullen AC, and Frey HC. Probabilistic Techniques in Exposure Assessment: A Handbook for Dealing with Variability and Uncertainty in Models and Inputs. New York: Plenum Press; 1999.
- Doherty J. Ground Water Model Calibration Using Pilot Points and Regularization. *Ground Water*. 2003;41(2):107–177.
- Doherty J. PEST: Model Independent Parameter Estimation; 2010. [cited 2012 July 24]; Available from <http://www.pesthomepage.org/Downloads.php>
- Ductile Iron Pipe Research Association (DIPRA). Hydraulic Analysis of Ductile Iron Pipe; 2002.
- ECG, Inc. Marine Corps Base Camp Lejeune and Marine Corps Air Station, New River, Water Conservation Analysis. Vienna, VA: ECG, Inc.; 1999.
- Faye RE, Anderson BA, Suárez-Soto RJ, and Sautner JB. Analyses and Historical Reconstruction of Groundwater Flow, Contaminant Fate and Transport, and Distribution of Drinking Water Within the Service Areas of the Hadnot Point and Holcomb Boulevard Water Treatment Plants and Vicinities, U.S. Marine Corps Base Camp Lejeune, North Carolina—Chapter C: Occurrence of Selected Contaminants in Groundwater at Installation Restoration Program Sites. Atlanta, GA: Agency for Toxic Substances and Disease Registry; 2010.
- Grayman WM, Maslia ML, and Sautner JB. Calibrating Distribution Systems Models with Fire-Flow Tests. *American Water Works Association, Optflow*. 2006;32(4)10–12.
- Hill MC, and Tiedeman CR. Effective Groundwater Model Calibration. Hoboken: John Wiley & Sons, Inc.; 2007.
- Maslia ML, Sautner JB, and Aral MM. Analysis of the 1998 Water-Distribution System Serving the Dover Township Area, New Jersey: Field-Data Collection Activities and Water-Distribution System Modeling. Atlanta, GA: Agency for Toxic Substances and Disease Registry; 2000.
- Maslia ML, Sautner JB, Aral MM, Gillig RE, Reyes JJ, and Williams RC. Historical Reconstruction of the Water-Distribution System Serving the Dover Township Area, New Jersey: January 1962–December 1996. Atlanta, GA: Agency for Toxic Substances and Disease Registry; 2001 October.
- Maslia ML, Sautner JB, Valenzuela C, Bove FJ, and Aral MM. Field Data Collection Activities for Water-Distribution Systems Serving Marine Corps Base Camp Lejeune, North Carolina. Preliminary Test and Tracer Study of the Hadnot Point Water-Distribution System: Draft Work Plan. Atlanta, GA: Agency for Toxic Substances and Disease Registry; 2004.
- Maslia ML, Sautner JB, Valenzuela C, Grayman WM, Aral MM, and Green JW Jr. Use of Continuous Recording Water-Quality Monitoring Equipment for Conducting Water-Distribution System Tracer Tests: The Good, the Bad, and the Ugly. Proceedings: World Environmental and Water Resources Congress; 2005 May 15–19; Anchorage, AK; 2005.
- Maslia ML, Sautner JB, Faye RE, Suárez-Soto RJ, Aral MM, Grayman WM, Jang W, Wang J, Bove FJ, Ruckart PZ, Valenzuela C, Green JW Jr, and Krueger AL. Analyses of Groundwater Flow, Contaminant Fate and Transport, and Distribution of Drinking Water at Tarawa Terrace and Vicinity, U.S. Marine Corps Base Camp Lejeune, North Carolina: Historical Reconstruction and Present-Day Conditions—Chapter A: Summary of Findings. Atlanta, GA: Agency for Toxic Substances and Disease Registry; 2007.
- Maslia ML, Suárez-Soto RJ, Wang J, Aral MM, Faye RE, Sautner JB, Valenzuela C, and Grayman WM. Analyses of Groundwater Flow, Contaminant Fate and Transport, and Distribution of Drinking Water at Tarawa Terrace and Vicinity, U.S. Marine Corps Base Camp Lejeune, North Carolina: Historical Reconstruction and Present-Day Conditions—Chapter I: Parameter Sensitivity, Uncertainty, and Variability Associated with Model Simulations of Groundwater Flow, Contaminant Fate and Transport, and Distribution of Drinking Water. Atlanta, GA: Agency for Toxic Substances and Disease Registry; 2009.
- Maslia ML, Suárez-Soto RJ, Sautner JB, Anderson BA, Jones LE, Faye RE, Aral MM, Guan J, Jang W, Telci IT, Grayman WM, Bove FJ, Ruckart PZ, and Moore SM. Analyses and Historical Reconstruction of Groundwater Flow, Contaminant Fate and Transport, and Distribution of Drinking Water Within the Service Areas of the Hadnot Point and Holcomb Boulevard Water Treatment Plants and Vicinities, U.S. Marine Corps Base Camp Lejeune, North Carolina—Chapter A: Summary and Findings. Atlanta, GA: Agency for Toxic Substances and Disease Registry; 2013.
- R Development Core Team. R: A Language and Environment for Statistical Computing. R Foundation for Statistical Computing. Vienna, Austria. ISBN 3-900051-07-0; 2010. Available from <http://www.R-project.org>
- Ross SM. Introduction to Probability Models. London, UK: Academic Press; 1997.
- Rossman LA. EPANET 2 Users Manual. Cincinnati: U.S. Environmental Protection Agency, National Risk Management Research Laboratory; 2000 September. Report No.: EPA/600–R–00/057.
- Saltelli A, Chan K, and Scott EM, editors. Sensitivity Analysis. Chichester, England: John Wiley & Sons, Ltd.; 2000.

- Sautner JB, Maslia ML, Valenzuela C, Grayman WM, Aral MM, and Green JW Jr. Field Testing of Water-Distribution Systems at the U.S. Marine Corps Base Camp Lejeune, North Carolina, in Support of an Epidemiologic Study. Proceedings: World Environmental and Water Resources Congress; 2005 May 15–19, Anchorage, AK.
- Sautner JB, Maslia ML, and Grayman WM. Storage Tank Mixing Models: Comparison of Tracer Data with Model Simulation. Proceedings: World Environmental and Water Resources Congress; 2007 May 15–19, Tampa, FL.
- Sautner JB, Anderson BA, Suárez-Soto RJ, and Maslia ML. Descriptions and Characterizations of Data Pertinent to Water-Supply Well Capacities, Histories, and Operations—Supplement 1. In: Maslia ML, Suárez-Soto RJ, Sautner JB, Anderson BA, Jones LE, Faye RE, Aral MM, Guan J, Jang W, Telci IT, Grayman WM, Bove FJ, Ruckart PZ, and Moore SM. Analyses and Historical Reconstruction of Groundwater Flow, Contaminant Fate and Transport, and Distribution of Drinking Water Within the Service Areas of the Hadnot Point and Holcomb Boulevard Water Treatment Plants and Vicinities, U.S. Marine Corps Base Camp Lejeune, North Carolina—Chapter A: Summary and Findings. Atlanta, GA: Agency for Toxic Substances and Disease Registry; 2013.
- Telci IT, Sautner JB, Suárez-Soto RJ, Anderson BA, Maslia ML, and Aral MM. Development and Application of a Methodology to Characterize Present-Day and Historical Water-Supply Well Operations—Supplement 2. In: Maslia ML, Suárez-Soto RJ, Sautner JB, Anderson BA, Jones LE, Faye RE, Aral MM, Guan J, Jang W, Telci IT, Grayman WM, Bove FJ, Ruckart PZ, and Moore SM. Analyses and Historical Reconstruction of Groundwater Flow, Contaminant Fate and Transport, and Distribution of Drinking Water Within the Service Areas of the Hadnot Point and Holcomb Boulevard Water Treatment Plants and Vicinities, U.S. Marine Corps Base Camp Lejeune, North Carolina—Chapter A: Summary and Findings. Atlanta, GA: Agency for Toxic Substances and Disease Registry; 2013.
- Tung Y-K and Yen B-C. *Hydrosystems Engineering Uncertainty Analysis*. McGraw-Hill; 2005.
- U.S. Environmental Protection Agency. *Guiding Principles for Monte Carlo Analysis*. Washington, DC: United States Environmental Protection Agency; 1997 March. Report No.: EPA 630-R-97-001.
- Walski TM. *Analysis of Water Distribution Systems*. Malabar, FL: Krieger Publishing Company; 1992.
- Walski TM, Chase DV, Savic DA, Grayman WM, Beckwith S, and Koelle E. *Advanced Water Distribution Modeling and Management*. Waterbury, CT: Haestad Press; 2003.

Appendix S8.1. Draft Work Plan Describing Procedures Developed and Methods Used to Collect Hydraulic and Water-Quality Data During Extensive Field Tests

By M.L. Maslia, J.B. Sautner, C. Valenzuela, F.J. Bove, and M.M. Aral

May 2004

**This draft work plan is presented as issued during May 2004.
Please see the Chapter A report for current (2013)
abbreviations and terminology.**

**FIELD DATA COLLECTION ACTIVITIES FOR WATER-DISTRIBUTION SYSTEMS
SERVING MARINE CORPS BASE, CAMP LEJEUNE, NORTH CAROLINA**

Preliminary Test and Tracer Study of the Hadnot Point Water-Distribution System

DRAFT WORK PLAN

Developed in cooperation with:

Department of the Navy
United States Marine Corps
Marine Corps Base, Camp Lejeune, North Carolina

Agency for Toxic Substances and Disease Registry
Atlanta, Georgia

May 1, 2004



AUTHORS

MORRIS L. MASLIA, MSCE, P.E., DEE
Research Environmental Engineer and Project Officer
Exposure-Dose Reconstruction Project
Division of Health Assessment and Consultation
Agency for Toxic Substances and Disease Registry

JASON B. SAUTNER, MSCE, E.I.T.
Environmental Health Scientist
Division of Health Assessment and Consultation
Agency for Toxic Substances and Disease Registry

CLAUDIA VALENZUELA, B.S.E.
Oak Ridge Fellow and Graduate Research Assistant
Oak Ridge Institute for Science and Education
School of Civil and Environmental Engineering
Georgia Institute of Technology

FRANK J. BOVE, SC.D.
Senior Epidemiologist
Division of Health Studies
Agency for Toxic Substances and Disease Registry

MUSTAFA M. ARAL, PH.D., P.E., PHY
Director, Multimedia Environmental Simulations Laboratory
School of Civil and Environmental Engineering
Georgia Institute of Technology

Disclaimer

Use of trade names and commercial sources is for identification only and does not imply endorsement by the Agency for Toxic Substances and Disease Registry or the U.S. Department of Health and Human Services.

FOREWORD

The Agency for Toxic Substances and Disease Registry (ATSDR) is conducting an epidemiologic study to determine if there is an association or potential link between exposure to contaminated drinking water and birth defects for women who were pregnant during the period 1968–1985. More than 12,000 women of childbearing age may have been exposed to well water contaminated with volatile organic compounds (VOCs) that was used for the potable water source and distributed through the water-distribution systems at Marine Corps Base, Camp Lejeune, North Carolina.

To quantify historical exposures needed by the epidemiologic study, ATSDR is using water-distribution system modeling to estimate the spatial and temporal distributions of contaminants in the historical water-distribution systems. To understand the historical water-distribution system characteristics, information based on the operation of the present-day water-distribution systems will be used in the process of historical reconstruction. The purpose of this work plan is to describe the general procedures that will be used to obtain hydraulic and water-quality data during an approximately three-day test of the Hadnot Point water-distribution system. These data will be used to assist in calibrating a present-day water-distribution model of the Hadnot Point water-distribution system.

CONTENTS

| | |
|---|-----|
| Authors | ii |
| Foreword | iii |
| List of Illustrations | v |
| List of Tables | vi |
| List of Appendices | vi |
| Background | 1 |
| Epidemiologic Study | 1 |
| Water-Distribution System Modeling | 1 |
| Rational for Conducting Preliminary Test | 2 |
| Conducting a Tracer Study | 3 |
| Test Procedures | 4 |
| Data Collection | 4 |
| Tracer Injection | 4 |
| Calcium chloride concentration | 4 |
| Fluoride concentration | 4 |
| Sampling Locations | 5 |
| Time Scheduling for Preliminary Test Activities | 6 |
| Test Equipment | 7 |
| Pressure Loggers | 7 |
| Dual Probe Fluoride and Chloride Ion and Conductivity Loggers | 7 |
| Single Probe Conductivity Loggers | 7 |
| Calcium Chloride Injection System | 8 |
| Sodium Fluoride Injection System | 8 |
| Training | 9 |
| Communications and Contingencies | 9 |
| Health and Safety Issues | 11 |
| Summary | 12 |
| References | 13 |

LIST OF ILLUSTRATIONS

Plate (located on page S8.157)

1. Map showing locations of pressure, fluoride-chloride, and conductivity loggers for conducting preliminary test of the Hadnot Point water-distribution system

Figure

1. Map showing location of study area
2. Map showing location of Hadnot Point and Holcomb Boulevard water-distribution systems.
3. Diagram showing location of fluoride and calcium chloride injection at the Hadnot Point water treatment plant for preliminary test.
4. Photographs showing location of tracer injection and generalized schematic of injection apparatus for tracer study of Hadnot Point water-distribution system.
5. Photographs showing calcium chloride solution to be used for tracer study of the Hadnot Point water-distribution system: (A) 55-gal drums, and (B) label showing 35% by weight.
6. Photograph showing sampling hydrant F03 marker flag mounted on 5-foot fiberglass pole (refer to Plate 1 and Appendix F for hydrant location).
7. Photograph showing: (A) Dixon PR300 continuous recording pressure data logger, (B) Dixon R022 filter kit (1/4 NPT x 1/4 NPTF), (C) Dixon brass lever handle shut-off valve (1/4 NPTF x 1/4 NPTF) in off position, (D) Hofmann brass nipple (1/4 NPT x 1/4 NPT), and (E) Dixon A7983 hydrant adapter kit.
8. Photograph showing: (A) nine-pin standard computer cable, and (B) Dixon PR300 continuous recording pressure gauge.
9. Photograph showing: (A) Class 1 hand-held pressure gauge, (B) Dixon R022 filter kit (1/4 NPT x 1/4 NPTF), (C) Dixon brass lever handle shut-off valve (1/4 NPTF x 1/4 NPTF) in off position, (D) Hofmann brass nipple (1/4 NPT x 1/4 NPT), and (E) Dixon A7983 hydrant adapter kit.
10. Photograph showing HORIBA W-23XD dual probe ion detector with: (A) fluoride and chloride sensors, and (B) pH, temperature, and conductivity sensors (located inside metal housing).
11. Photograph showing: (A) HORIBA W-23XD dual probe ion detector, (B) flow cell with (C) Rectus 21KANNMPX, 1/4 NPT brass connectors.
12. Photograph showing: (A) HORIBA W-23XD dual probe ion detector and flow cell housed in (B) protective 5-gallon plastic water jug.
13. Photograph showing: (A) Dixon A7893 hydrant adapter kit, (B) 1/4 NPT brass “T”, and (C) 1/4 NPTF ball valves.
14. Photograph showing: (A) hydrant adapter kit, bass “T”, and ball valve configuration, (B) Rectus PSCH0605-16, 5-foot orange hose for collecting grab sample, (C) Rectus PSCH0610-3, 10-foot blue hose for supplying flow cell with hydrant water, (D) Rectus PSCH0605-5, 5-foot yellow hose for discharging water from flow cell, (E) 5-gallon protective plastic water jug housing the HORIBA W-23XD dual-probe ion detector and flow cell, and (F) chain and lock securing equipment to hydrant.
15. Photograph showing HORIBA W-23XD water-quality control unit and cable attached to dual probe ion detector housed in a protective plastic 5-gallon water jug.

16. Photograph showing: (A) HORIBA W-21XD single probe water-quality measurement logger, (B) control unit for downloading data from logger, and (C) cable to connect control unit to probe.
17. Picture and schematic of 525-gallon storage tank used to store calcium chloride (CaCl_2) solution for tracer test.
18. Diagram showing Schematic of Tuthill TX-series pump for calcium chloride (CaCl_2) solution tracer injection.
19. Photographs showing : (A) Tuthill TX-series pump, (B) Baldor $\frac{1}{2}$ -horsepower inverter motor, and (C) controls for picking up 4-20 miliamp signal.
20. Diagrams showing Fluoride injection system for Hadnot Point tracer study: (A) LMI 50-gallon saturator kit, and (B) LMI chemical feed pump and flow controller for picking up 4-20 miliamp signal.
21. Photographs showing training session at ATSDR facilities on installation, calibration, and use of HORIBA W-23XD water-quality monitoring system, April 21, 2004.
22. Photograph showing 25-unit first aid kit.
23. Photograph showing outdoor skin protection kit.
24. Photograph showing orange fluorescent safety vest to be worn by tracer study tem members.

LIST OF TABLES

Table

1. Pressure measurements for selected test hydrants, Hadnot Point water-distribution system, April 19, 2004
2. Water-distribution system data collection methods, Hadnot Point water-distribution system, Marine Corps Base, Camp Lejeune, North Carolina.
3. Schedule of preliminary test activities, Hadnot Point water-distribution system, Marine Corps Base, Camp Lejeune, North Carolina, May 17–27, 2004.
4. Duties and responsibilities of ATSDR staff during tracer study test, Hadnot Point water-distribution system, Marine Corps Base, Camp Lejeune, North Carolina, May 17–27, 2004.

LIST OF APPENDICES

Appendix

- A. Chemical Mass Balance Computations for Calcium Chloride (CaCl_2) Solution
- B. Material Safety Data Sheet (MSDS) for Calcium Chloride (CaCl_2) Solution
- C. Chemical Mass Balance Computations for Sodium Fluoride (NaF) Solution
- D. Material Safety Data Sheet (MSDS) for Sodium Fluoride (NaF)
- E. Chemical Mass Balance Computations for Fluoride Solution Using the LMI Fluoride Saturator Kit Number 28850
- F. Descriptions of Test Hydrant and Sampling Locations
- G. Data-Entry Log Sheets
- H. Training Agenda for HORIBA Data Loggers
- I. Signage for Sampling Hydrant Locations

**FIELD DATA COLLECTION ACTIVITIES FOR WATER-DISTRIBUTION SYSTEMS
SERVING MARINE CORPS BASE, CAMP LEJEUNE, NORTH CAROLINA**

Preliminary Test and Tracer Study of the Hadnot Point Water-Distribution System

DRAFT WORK PLAN

By M.L. Maslia, J.B. Sautner, C. Valenzuela, F.J. Bove, and M.M. Aral

BACKGROUND

Camp Lejeune is a military base adjacent to and southeast of Jacksonville, Onslow County, North Carolina (Figure 1). It covers approximately 164 square miles and consists of six Marine Corps commands and two Navy commands. The population of the base includes active military personnel and their dependents (43,000 and 52,000, respectively). Base housing for enlisted personnel, officers, and their families are located in 15 different areas on the base (ATSDR 1998). More than 100 groundwater wells have been drilled to supply water for base activities. Almost all of the wells withdraw water from the permeable Castle Hayne aquifer which is composed of 60 to 90 percent sand and limestone (Harned et al. 1989, Cardinell et al. 1993).

Volatile organic compound (VOC) contamination of drinking water was first detected at Camp Lejeune in 1982. The start of contamination, however, is unknown. It is believed that the source of the contamination may have originated from a dry cleaning business located off base. The contaminated wells were not capped until 1985.

EPIDEMIOLOGIC STUDY

The Agency for Toxic Substances and Disease Registry (ATSDR) is conducting an epidemiologic study to determine if there is an association or potential link between exposure to contaminated water and birth defects for women who were pregnant during the period 1968–1985. More than 12,000 women of childbearing age who may have been exposed to the contaminated well water have been interviewed to date. As part of the epidemiologic study, the frequency, duration, and spatial distribution of human exposure to contaminated potable water need to be assessed and quantified. Water-distribution system modeling is being used by engineers and environmental health scientists at ATSDR as part of the process of quantifying historical exposures.

WATER-DISTRIBUTION SYSTEM MODELING

Owing to the paucity of historical, contaminant-specific, water-quality data at points of exposure, water-distribution system modeling is being used by ATSDR to synthesize temporal and spatial distributions of contaminants throughout the water-distribution systems serving populations that resided at Camp Lejeune from 1968–1985. To understand the historical water-distribution system characteristics, information based on the operation of the present-day water-

distribution systems will be used in the process of historical reconstruction (Maslia et al. 2001). To model present-day and historical water-distribution systems, an extended period simulation water-quality model (EPANET 2 [Rossman 2000]) must be calibrated against present-day field data. The purpose of this work plan is to describe the general procedures that will be used to obtain hydraulic (pressure and hydraulic head) and water-quality data (fluoride and chloride concentrations and conductivity) during an approximately three-day preliminary test of the water-distribution system serving Camp Lejeune.

Rational for Conducting Preliminary Test

For purposes of the epidemiologic study, the two water-distribution systems of interest at Camp Lejeune are Hadnot Point (HP) and Holcomb Boulevard (HB). Each is presently serviced by a water treatment plant known by the same name (Figure 2). Spatial and temporal distributions of parameter data (such as pressure, hydraulic head, pipe roughness coefficients, flows, and fluoride concentration) do not exist for the HP and HB water-distribution systems. Additionally, water-distribution system models have not been developed for the present-day or the historical systems. Thus, a preliminary test can be used to gather data solely from the Hadnot Point water-distribution system and will last for a limited duration of time (2–3 days). This approach is best suited for establishing initial water-distribution system parameters needed for more comprehensive field tests and model calibration. For purposes of conducting a preliminary field test, ATSDR staff, in cooperation with Camp Lejeune civilian staff and military personnel, decided that testing a single system rather than the combined HP and HB water-distribution system would be more manageable in terms of data gathering, personnel, and analyses. The HP water-distribution system was chosen to conduct the preliminary field test for the following reasons:

- The HP water-distribution system serviced the area that is now serviced by the HB water-distribution system prior to 1972, a period of interest for the epidemiologic study;
- The HP water-distribution system is operated manually, and therefore, can be more readily controlled during a field test; and
- At present (and for much of the historical period) the HP water-distribution system is (was) operated separately from the HB water-distribution system (by use of shut-off valves), thereby allowing investigators an opportunity to observe and measure water-quality parameters by conducting a tracer test without interference from the operation of the HB water-distribution system.

A detailed description of procedures developed to collect hydraulic data (pressure and hydraulic head) during extensive field tests is provided in Maslia et al. (2000a, b). Similar techniques will be used to obtain hydraulic data for the HP water-distribution system. However, based on preliminary field measurements at 9 selected hydrants, pressures ranged between 58 and 65 pounds per square inch (psi) with a mean value of 60 psi (Table 1). Considering the nearly flat terrain at Camp Lejeune, the resulting hydraulic gradient is extremely small. Attempting to calibrate a water-distribution system model solely based on pressure or hydraulic head data may prove infeasible, yield non-unique results, and result in a poorly calibrated water-quality network model. To address this situation, water-quality parameter data (fluoride and chloride concentrations and conductivity) will also be collected by conducting a tracer study of

the HP water-distribution system. In this manner, results from the tracer study can be used as a calibration tool (Grayman 2001).

Conducting a Tracer Study

A tracer study is a method for observing and measuring the movement of water within a water-distribution system. In this type of study a conservative substance, such as calcium chloride, can be injected into the water supply and the resulting concentration can be measured in terms of its spatial and temporal distribution as it moves through the distribution system. Alternatively, if a water-distribution system contains a compound at a known concentration, such as fluoride, the source of the compound can be abruptly shut off, and the decay of the compound (in this case, fluoride) can also be measured in terms of its spatial and temporal distribution as it decays throughout the distribution system. Details pertaining to the background and procedures of conducting a tracer study are described in Clark et al. (2004) and will not be repeated here.

The choice of the type of tracer that should be used to conduct a tracer study should be predicated on the following criteria: (1) regulatory requirements, (2) analytical methods for measuring tracer concentration, (3) injection and operational requirements, (4) chemical composition of the finished or treated water, (5) cost of the tracer, and (6) public perception. Four commonly used tracers in distribution systems are fluoride, calcium chloride, sodium chloride, and lithium chloride. The advantages and disadvantages of using each compound as a tracer for analysis of water-distribution systems are discussed in Clark et al. (2004). For testing the HP water-distribution system, fluoride and calcium chloride will be used. The reasons are:

- The HP water-distribution system currently uses fluoride (sodium fluoride crystals) to fluoridate the treated water so that a delivered water concentration of approximately 1 milligram per liter (mg/L) is achieved (TH Burton, MCB Camp Lejeune, written communication, October 15, 2003). Thus, delivered water contains fluoride that can be shutoff and re-injected for a tracer study;
- Calcium chloride requires only one secondary maximum contaminant level (MCL) standard to be met—chloride at 250 mg/L. HP water contains low chloride concentrations—raw water at 0.14 mg/L (BT Ashton, MCB Camp Lejeune, written communication, April 6, 2004) and treated water at 20 mg/L (BT Ashton, MCB Camp Lejeune, written communication, March 31, 2004). Therefore, the injection concentration for calcium chloride can be kept low so that the chloride concentration is well below the 250 mg/L MCL while still producing a measurable effect for the tracer study; and
- The cost of food grade liquid calcium chloride (35% by weight) is inexpensive at approximately \$4.00 per gallon (gal) and can be delivered in convenient 55-gal drums (J. Weyenth, Benbow Chemical Packaging, Inc., written communication, April 1, 2004).

A tracer study is conceptually very simple, although successfully executing the study requires careful planning, coordination with water-utility personnel, regulatory agencies, and fire and safety officials, and judicious implementation to achieve useful results. The discussion in the section below on “Test Procedures” addresses these issues.

TEST PROCEDURES

Data Collection

Data to be collected during the preliminary field test are: distribution system pressures, hydraulic heads in elevated storage tanks, pumpage from groundwater supply wells, flows from raw-water pumps and treated water booster pumps, system operation procedures (on/off cycling of wells and pumps), fluoride¹ and chloride concentrations, and conductivity². A description of types of data and the means by which they will be collected are listed in Table 2.

Tracer Injection

Careful planning must be used to insure that tracers injected into the treated water do not exceed state or federal standards for protecting the environment and public health while conducting the tracer study. Therefore, a review of expected tracer concentrations is presented below (refer to the section on “Time Schedule” for occurrence of specific activities relative to tracer injections). All tracer injections will take place at an injection port that is located on the treated water side of the HP water-treatment plant. Figure 3 shows a schematic of the HP water treatment plant and the location of the tracer injection point referenced to the water treatment plant. Figure 4 shows photographs of the point of injection with a generalized schematic of the tracer injection apparatus. Both Figures 3 and 4 clearly show that injection will occur on the delivered water side of the HP water-treatment plant.

Calcium chloride concentration. The calcium chloride (CaCl_2) solution that will be used for the tracer study is delivered in 55-gal drums and is 35% CaCl_2 by weight (Figure 5). As previously discussed, the resulting chloride concentration from the mixture of treated (delivered) water and CaCl_2 must not exceed the secondary standard MCL of 250 mg/L. To assure the public’s health and safety, an upper limit concentration for the tracer study using CaCl_2 is set at 200 mg/L. To estimate the concentration that will be achieved by injecting the CaCl_2 solution, chemical mass balance computations were conducted using the average flow for May 2002 of 3 million gallons per day (MGD) or 125,000 gallons per hour (gph), 35% CaCl_2 solution by weight, a background chloride concentration of HP water of 20 mg/L (BT Ashton, MCB Camp Lejeune, written communication, March 31, 2004), and a 4- to 6-hour injection time using a 60 gph flow-paced injection pump³. Based on these data, and the assumption of complete mixing a very short distance away from the injection point, the maximum chloride concentration is computed to be 164 mg/L which is well below the allowable MCL of 250 mg/L (Appendix A). The material safety data sheet (MSDS) for calcium chloride is provided in Appendix B.

Fluoride concentration. To collect appropriate fluoride data that will be useful in understanding the fate and transport of constituents in the distribution system, the injection of fluoride at the water treatment plant will be shut off prior to the start of the test so that approximate equilibrium concentration conditions can be achieved at fluoride sampling locations (Plate 1). For the HP water-distribution system, this will occur when fluoride concentrations approach 0.2 mg/L

¹ At present, treated water at the HP water-treatment plant (WTP) is fluoridated so that a concentration of approximately 1 mg/L is maintained throughout the distribution system.

² Chloride concentration in mg/L and conductivity in microsiemens per centimeter ($\mu\text{S}/\text{cm}$) will be collected as a result of injecting a calcium chloride solution into treated water at the HP WTP.

³ A flow-paced pump will assure that as the flow rate of delivered water changes based on demand, CaCl_2 injection rate will also change to maintain a near-constant concentration of the mixed CaCl_2 and treated water.

because this is the concentration of fluoride in the raw (or untreated) water (BT Ashton, MCB Camp Lejeune, written communication, April 6, 2004). Fluoride will then be re-introduced into the distribution system to achieve a maximum distribution-system concentration of 2 mg/L. The location of the fluoride injection will be at the same location used for the calcium chloride injection (Figures 3 and 4).

The source of the fluoride for tracer injection will be sodium fluoride (NaF) crystals used at the HP water treatment plant. To assure the public's health and safety, an upper limit fluoride concentration for the tracer study using NaF is set at 2 mg/L. To estimate the concentration that will be achieved by injecting the NaF solution, chemical mass balance computations were conducted using the average flow for May 2002 of 3 million gallons per day (MGD) or 125,000 gallons per hour (gph), a maximum background fluoride concentration of HP water of 0.2 mg/L (BT Ashton, MCB Camp Lejeune, written communication, April 6, 2004), and a 4- to 6-hour injection time using a 60 gph flow-paced injection pump. Based on these data, and the assumption of complete mixing a very short distance away from the injection point, it is estimated that about 36 pounds of NaF crystals will be required (when mixed 500 gallons of water) to achieve a maximum fluoride concentration of 2 mg/L in the delivered water (Appendix C). The material safety data sheet (MSDS) for the sodium fluoride that is used at the HP water treatment plant is provided in Appendix D.

An alternative approach to injecting the fluoride solution (by mixing NaF crystals with 500 gallons of water in a storage tank) is to use a chemical feed pump and a saturator kit (e.g., LMI fluoride saturator kit, part number 28850). With this approach, a 50-pound bag of NaF crystals is placed in the bottom of the saturator and water is added so that the saturator maintains a solution of 4% fluoride. With a background concentration of 0.2 mg/L (BT Ashton, MCB Camp Lejeune, written communication, April 6, 2004), and a maximum allowable concentration (for the tracer test) after injecting the fluoride of 2 mg/L, an additional 1.8 mg/L of fluoride need to be injected from the saturator. The 4% fluoride solution that is maintained by the saturator is equivalent to 40,000 mg/L. Therefore, the required dilution of the 4% solution is 22,222:1 (40,000 mg/L divided by 1.8 mg/L). With an average flow rate of 3 MGD (125,000 gph), 5.6 gph of the 4% fluoride solution would be added at the injection port from the fluoride saturator kit. For a 4- to 6-hour tracer test, 22 to 34 gallons of 4% fluoride solution would be required to be injected. This is within the volumetric capacity of the saturator kit which holds 50 gallons of solution. A summary of these calculations is provided in Appendix E. Using the saturator kit approach avoids having to manually or mechanically mix the NaF crystals with water in the 500 gallon tank as previously discussed. Therefore, this approach and equipment (saturator kit) will be used to inject fluoride for the tracer test of the HP water-distribution system.

Sampling Locations

Twenty seven sampling locations will be used for the preliminary test to gather data on pressure, fluoride, chloride, and conductivity (Plate 1; Appendix F, Table F-1). Nine hydrant locations will be equipped with continuous-recording pressure loggers (Dixon PR300; Table 1), nine locations will be equipped with continuous-recording loggers that will monitor fluoride, chloride, and conductivity (HORIBA W-23XD, Table 1), and the remaining nine locations will be equipped with continuous-recording conductivity loggers (HORIBA W-21XD, Table 1). On Plate 1, the pressure monitoring hydrants are designated with the letter "P", the combined fluoride, chloride, and conductivity monitoring hydrants are designated with the letter "F", and

the conductivity monitoring hydrants are designated with the letter “C.” Appendix F (Table F-1) provides a comprehensive description of sampling locations. Test hydrants are marked with five-foot red and white fiberglass poles that have a red plastic flag at the top of the pole with the designated sampling hydrant identification (Figure 6).

Quality assurance and quality control (QA/QC) procedures for continuous-recording loggers will be instituted by having members of the ATSDR tracer study team make rounds at each of the loggers to check data that is being recorded at the monitoring locations. Team members will record pressures and water-quality parameters on data-entry log sheets as well as obtain grab samples of water for analysis of fluoride and chloride concentrations and conductivity. The analysis will be conducted at a temporary water-quality laboratory set up within the confines of the HP water-treatment plant. Examples of data-entry log sheets that will be used during the tracer study are provided in Appendix G.

Time Scheduling for Preliminary Test Activities

The scheduling of activities prior to and during the preliminary test is listed in Table 3. Installation of equipment is scheduled to begin on Monday, May 17, 2004. While tracer injection equipment (tank and flow-paced pump) are being installed, ATSDR staff will begin installing and calibrating continuous-recording data loggers. The loggers will be activated so that background data on pressure, fluoride and chloride concentrations, and conductivity can be gathered prior to the start of the test. After all loggers are installed, the HP water treatment plant fluoride system will be shut off and the decay of fluoride concentration throughout the distribution system will be closely monitored by use of the continuous-recording data loggers (Plate 1). Based on preliminary water-quality model simulation, it is estimated that within 48 hours the fluoride concentration throughout the HP water-distribution system will have attained a concentration of 0.2 mg/L⁴.

The test will begin on Monday, May 24, 2004, at 0800 hours when the CaCl₂ solution injection will begin. Specific duties and responsibilities of ATSDR test staff are listed in Table 4. The injection will last 4 to 6 hours, depending on the actual flow rate of delivered water at the time of the test and results of monitoring and grab-sample data analyses during the day. Fluoride injection will begin at 0800 hours on Tuesday, May 25, 2004 and will also last 4 to 6 hours, depending on the actual flow rate of delivered water at the time of the test and results of monitoring and grab-sample data analyses during the day. Based on monitoring and grab-sample data after the fluoride injection is discontinued, it is anticipated that on Wednesday, May 19, normal WTP operations at HP can resume by turning on the HP fluoride injection system. During the tracer study test (May 24–26), ATSDR staff will be assigned different tasks as listed in Table 4. There will always be test staff at the HP water treatment plant to continuously monitor injection pumps and resulting concentrations of both CaCl₂ and fluoride and discuss any operational changes required from this plan with water utility staff (Table 3). It should be noted, however, that activities and task times listed in Tables 3 and 4 are approximate and may be

⁴ Because of the manner in which the HP water-distribution system is operated, only the French Creek elevated storage tank water level is allowed to fluctuate. Therefore, the remaining elevated storage tanks will still contain water that has a fluoride concentration of approximately 1 mg/L. This water will not significantly affect the tracer study result should any of the water be released into the distribution system during the tracer study test.

modified during the progression of the test in response to test conditions and communications between Camp Lejeune water utility staff and ATSDR test staff.

TEST EQUIPMENT

Equipment utilized for the test will enable continuous gathering of data for system pressures, fluoride and chloride concentrations, and conductivity. Additionally, injection pump equipment and 525-gallon storage tanks will be used to conduct the tracer study. Descriptions of the monitoring equipment and methods by which they will be attached to the test hydrants (Plate 1) are described below.

Pressure Loggers

Pressure data will be gathered using the Dixon PR300 continuous pressure data logger (Figure 7) at sampling locations P01–P09 (Plate 1). It will be attached to a hydrant using a Dixon A7983 hydrant adapter kit and a Dixon R022 filter kit (1/4 NPT x 1/4 NPTF). During the test, real-time pressure can be viewed by connecting a nine-pin cable to a standard computer port (COM1 or COM2 port), as shown in Figure 8. This is also the means by which all recorded data is retrieved. For QA/QC purposes, pressures will be measured during installation and during removal of the continuous-recording pressure logger by using a Class 1 hand-held pressure gage that can be attached to the Dixon A7983 hydrant adapter kit as shown in Figure 9.

Dual Probe Fluoride and Chloride Ion and Conductivity Loggers

To record fluoride and chloride concentration and conductivity data simultaneously (sampling locations F01–F09, Plate 1, Table F-1), the HORIBA W-23XD dual probe, multi-parameter water-quality monitoring system will be used. This system consists of dual probe ion detector, (fluoride and chloride ion sensors and conductivity sensor, Figure 10), and a flow cell that fits the double probe W-23XD (Figure 11). The probe and flow cell will be housed in a plastic protective container which is a standard 5-gallon water jug (Figure 12). Water will pass through the flow cell by attaching a Dixon A7893 hydrant adapter kit to the sampling location hydrant. The adapter kit will be configured with a 1/4 NPT brass “T” and two 1/4-inch ball valves on each side of the brass “T” (Figure 13). One valve will be used to control flow into the flow cell and the other valve will be used to turn water on and off when obtaining grab samples from the hydrant (Figure 14). The complete configuration consisting of the HORIBA W-23XD probe, flow cell, and 5-gallon plastic protective water jug will be secured to the hydrant by means of a chain and lock as shown in Figure 14. There will be a continuous discharge of water coming from the flow cell and plastic protective container (approximately 1–2 gallons per minute). To monitor and download fluoride and chloride concentration and conductivity data, the HORIBA water-quality control unit is attached to the sensor probe using a cable (Figure 15). With the configuration described above, the data logger continues to record data while real-time data values can be viewed using the HORIBA water-quality control unit and grab samples can be obtained for QA/QC analyses.

Single Probe Conductivity Loggers

Because of the cost of the dual probe loggers described above, and the need to have additional sampling stations, a single probe continuous recording logger will be used to record conductivity at hydrant sampling stations C01–C09 (Plate 1, Table F-1). By measuring

conductivity, chloride concentration can be determined from a conductivity versus chloride calibration curve that is determined in the laboratory using HP water. The water-quality monitoring system that will be used at the conductivity sampling hydrants C01–C09 is the HORIBA 21XD single-probe water-quality measurement logger (Figure 16). The single-probe unit will be attached to the sampling hydrant in the same manner as discussed above for the dual-probe unit (Figure 14). To monitor and download conductivity data, the HORIBA water-quality control unit is attached to the sensor probe using a cable as previously described and shown in Figure 16.

Calcium Chloride Injection System

As describe in the section on “Calcium chloride concentration,” about 8 drums of 35% by weight CaCl_2 solution (55-gallons per drum) will be pumped into a holding tank and then injected into the delivered water (Figures 3 and 4). The holding tank has a volume of 525 gallons and a picture of the tank and a schematic are shown in Figure 17. To pump the CaCl_2 solution from the 525-gallon tank into the injection port (Figure 4) a Tuthill TX-series pump will be used. The pump is driven by a Baldor $\frac{1}{2}$ -horsepower, 1,725 revolutions per minute (RPM) inverter drive motor with controls that can pick up a 4-20 miliamp signal from a discharge venturi meter. The pump is capable of delivering approximately 120 gph (2 gallons per minute) at 100 psi. A schematic of the pump is shown in Figure 18 and photographs of the pump and motor controls are shown in Figure 19.

Sodium Fluoride Injection System

As discussed in the section on “Fluoride concentration,” there are two approaches that are considered for injecting fluoride into the distribution system. The first approach requires 36 pounds of NaF crystals to be mixed with about 500 gallons of water in the holding tank described above (Figure 17). Then the mixture is pumped into the delivered water through the injection port (Figure 4) using the pump and motor mechanism described above (Figures 18 and 19).

The second approach uses a fluoride saturator mechanism and a chemical feed pump. The saturator mixes the NaF crystals with inflowing water and assures a consistent fluoride saturation of 4% (40,000 mg/L). The advantage of this approach is that for the tracer test being planned, only one bag (50 pounds) of NaF crystals needs to be placed at the bottom of the saturator and no additional manual or mechanical mixing is required by the tracer study staff. Additionally, the chemical feed pump will assure that a consistent amount of fluoride solution is injected into the delivered water stream based on the delivered water flow rate⁵. For the fluoride injection, the saturator kit and chemical feed pump will be used. Therefore, the fluoride injection system will consist of a 525-gallon tank (Figure 17) to hold treated water where the fluoride concentration has decayed to 0.2 mg/L (refer to section on “Fluoride concentration” and Table 3). The LMI 50-gallon saturator kit and chemical feed pump with flow controller for picking up a 4-20 miliamp signal from the delivered water venturi meter are show in Figure 20.

⁵ It should be noted, however, that based on computations provided in Appendices C and E, both approaches will result in delivered fluoride concentration of 2 mg/L or less.

TRAINING

A day-long training session was held at ATSDR, in Atlanta, Georgia, on April 21, 2004. The purpose of the training session was to introduce tracer test team members to the installation, calibration, and use of the HORIBA W-23XD water-quality monitoring system. Representatives from the manufacturer and vendor of the water-quality monitoring system were present to provide instruction and guidance on calibrating and using the instruments as well as to answer any questions. Furthermore, instruction on laboratory techniques with respect to calibrating the instruments and conducting QA/QC on the instrument was also provided to team members. Figure 21 shows team members and instructional staff during the training session. A sample of the training agenda is presented in Appendix H.

During the week of May 17–19, when loggers and injection pump equipment will be installed (Table 3), training on the use of the chemical feed and injection pumps will also be conducted. The training will be attended by the three ATSDR tracer study team members on site during the week (Table 3) and Camp Lejeune water-utility operations staff that will be operating the HP water-distribution system during the tracer test study period. The purpose of this training will be to review the calibration procedures and operations of the chemical injection pump equipment to assure that during the tracer injection (May 24 and 25, Table 3) the required amount of CaCl_2 solution and fluoride will be injected into the distribution system.

COMMUNICATIONS AND CONTINGENCIES

All sampling hydrants will be marked with signage providing information to those on base as to the purpose of the tracer test and who they should contact with any questions. A copy of the signage that will be used is provided in Appendix I. Figure 14 shows how the signage will be displayed at all sampling hydrant locations.

The ATSDR project officer will be the “person-in-charge” for the ATSDR tracer study team. Any modifications of test procedures or activities as described herein—required as a result of actual field conditions—will involve decisions made in consultation with the ATSDR project officer. The ATSDR project officer will be the liaison between the tracer study team and the Camp Lejeune water utility staff and military personnel. The project officer will be the agency’s representative who communicates work plan changes to the tracer study team and to Camp Lejeune water-utility staff and military personnel.

The ATSDR tracer study team will have in their possession at all times during the tracer study a minimum four cellular telephones or two-way radio communication devices. The telephones or two-way radios will be located at the HP water-treatment plant and with tracer study staff conducting QA/QC at pressure sampling hydrants (P01–P09; Plate 1), fluoride and chloride sampling hydrants (F01–F09), and conductivity sampling hydrants (C01–C09). ATSDR tracer study team members (including the project officer) will have in their possession at all times a complete list of all cellular telephone numbers and radio frequencies.

Of paramount importance are the health and safety of the public (military and civilian) that will be using water from the HP water-distribution system during the tracer study. For the Camp

Lejeune water utility staff, the shift foreman shall be present during the 4-6 hour period of chemical injection (CaCl_2 and NaF). For ATSDR, two tracer study team members will always be present at the HP water treatment plant to closely monitor the injection of tracer solution and the resulting concentration in delivered water (at sampling hydrant F03 which is located next to the HP water treatment plant) during the tracer injection (Table 4).

The ATSDR tracer study team will frequently monitor the fluoride and chloride levels at the sampling hydrant locations (F01–F09 and C01–C09; Plate 1) to assure that chloride concentrations are below 200 mg/L and fluoride concentrations are below 2 mg/L. Should concentrations at the sampling hydrants exceed these levels—based on data obtained from either the continuous recording loggers (Figures 10 and 16) or the QA/QC grab samples—then: (1) The ATSDR project officer will immediately be notified as to the resulting concentration, the sampling hydrant identification, and whether the exceeding concentration was observed from a continuous recording logger or a grab sample, and (2) The ATSDR project officer will communicate these findings to the Camp Lejeune water-utility shift foreman. Based on the concentration of the specific tracer constituent (Cl or F), the following procedures will be followed:

- (1) Chloride concentration exceeding 200 mg/L and less than 250 mg/L,
 - a. More frequent monitoring of continuous recording loggers will begin and additional QA/QC grab samples will be obtained from sampling hydrants to more closely assess if there is a trend to the increasing chloride concentrations;
 - b. Verification grab samples shall be taken at the sampling hydrant that indicated the exceeding concentration and immediately brought back to the water-quality lab at the HP water-treatment plant for analysis; and
 - c. If the additional QA/QC grab samples indicate concentrations within acceptable limits (200 mg/L or less), the QA/QC sampling frequency may be reduced after consultation between the ATSDR project officer and the water utility shift foreman.
- (2) Chloride concentration exceeds 250 mg/L,
 - a. The CaCl_2 chemical feed equipment (Figure 20) will be shut off;
 - b. Verification grab samples shall be taken at the sampling hydrant that indicated the exceeding concentration and immediately brought back to the water-quality lab at the HP water treatment plant for analysis;
 - c. If the additional QA/QC grab samples indicate concentrations of less than 250 mg/L, the injection equipment may be turned back on and the tracer injection resumed after consultations between the ATSDR project officer and the Camp Lejeune water utility shift foreman; and
 - d. Should the additional QA/QC grab samples confirm a concentration exceeding 250 mg/L, then North Carolina Department of Environment and Natural Resources will be contacted by Camp Lejeune water utility staff.
- (3) Fluoride concentration exceeding 2 mg/L and less than 4 mg/L,
 - a. The NaF chemical feed equipment (Figure 19) will be shut off;
 - b. Verification grab samples shall be taken at the sampling hydrant that indicated the exceeding concentration and immediately brought back to the water-quality lab at the HP water treatment plant for analysis;

- c. If the additional QA/QC grab samples indicate concentrations of less than 2 mg/L, the injection equipment may be turned back on and the tracer injection resumed after consultations between the ATSDR project officer and the Camp Lejeune water utility shift foreman; and
 - d. Should the additional QA/QC grab samples confirm a concentration exceeding 2 mg/L, then North Carolina Department of Environment and Natural Resources will be contacted by Camp Lejeune water utility staff.
- (4) Fluoride concentration exceeds 4 mg/L,
- a. The NaF chemical feed equipment (Figures 19) will be shut off;
 - b. The entire HP water-distribution system will be flushed until fluoride residuals reach acceptable levels (less than 2 mg/L);
 - c. If flushing is initiated, the hydrants will essentially flush elevated storage tanks, S-5, S-29, S-1000, and SFC-314;
 - d. High lift pumps will be secured and water levels in storage tanks will be allowed to decline several feet while flushing the hydrants; and
 - e. Pumps will be turned back on and Camp Lejeune water utility personnel will continue to flush the distribution system with water from the reservoir.

HEALTH AND SAFETY ISSUES

All traffic regulations, procedures, and laws will be strictly observed by ATSDR tracer study team members when driving vehicles on site at Camp Lejeune. This includes, obeying all posted vehicle speed regulations. Each vehicle occupant must wear a seat belt and assure that it is securely buckled at all times when the vehicle is moving.

Each vehicle that will be used by the ATSDR tracer study team will be equipped with a 25-unit first aid kit. Additionally, tracer test members stationed at the HP water treatment plant will also have the first aid kit available to them. Figure 22 shows a photograph of a typical first aid kit that will be available on site. Because of the duration of time that ATSDR tracer study team members may be out in the sun conducting QA/QC on the sampling hydrant locations, team members will also be provided with sun block cream (SPF 30 or higher) to protect their skin from the possibility of long exposure to the sun. Additionally, fire ants, other stinging insects, and rash-causing vegetation such as poison ivy are found on-site as Camp Lejeune. Therefore, each tracer study team member will be supplied with an outdoor skin protection kit, shown in Figure 23.

Because of security issues at Camp Lejeune, all ATSDR tracer study team members must have on their possession at all times proper identification. This can be either a valid driver's license or a government employee identification card. Team members will wear T-shirts that contain the ATSDR agency name so that team members can be identified while on base at camp Lejeune by both military personnel and civilians.

ATSDR tracer study team members will be supplied with an orange fluorescent traffic safety vest. The vest will be worn at all times when team members are conducting activities at the

sampling hydrant locations. Figure 24 is a photograph of a typical traffic safety vest that will be worn by team members.

SUMMARY

ATSDR is conducting an epidemiologic study to determine if there is an association or potential link between exposure to contaminated drinking water at Camp Lejeune, North Carolina, and birth defects for women who were pregnant during the period 1968–1985. To understand the historical water-distribution system characteristics, information based on the operation of the present-day water-distribution system will be used in the process of historical reconstruction. To obtain present-day data and information, a tracer study test of the HP water-distribution system is planned for May 24-16, 2004. This work plan describes the general procedures, water-quality monitoring equipment, and tracer injection equipment that will be used to obtain hydraulic and water-quality data during an approximately three-day tracer study test of the HP water-distribution system.

REFERENCES

- ATSDR 1998. Volatile organic compounds in drinking water and adverse pregnancy outcomes, United States Marine Corps Base, Camp Lejeune, North Carolina. Atlanta: Agency for Toxic Substances and Disease Registry.
- Cardinell, AP, Berg SA, Lloyd Jr., OB. 1993. Hydrogeologic framework of U.S. Marine Corps Base at Camp Lejeune, North Carolina. Raleigh: U.S. Geological Survey, Water-Resources Investigations Report 93-4049.
- Clark, RM, Grayman, WM, Buchberger, SG, Lee, Y, Hartman, DJ. 2004. Drinking water distribution systems: an overview. In: Mays, LW, editor. Water supply systems security, New York: McGraw-Hill, p.4.1–4.49.
- Grayman, WM. 2001. Use of tracer studies and water quality models to calibrate a network hydraulic model. In: Straface, AM, et al., editors. Essential hydraulics and hydrology, Waterbury (CT): Haestad Press, p. 3–8.
- Harned, DA, Lloyd, Jr., OB, Treece, Jr., MW. 1989. Assessment of hydrologic and hydrogeologic data at Camp Lejeune Marine Corps Base, North Carolina. Raleigh: U.S. Geological Survey, Water-Resources Investigations Report 89-4096.
- Maslia, ML, Sautner, JB, and Aral, MM. 2000. Analysis of the 1998 water-distribution system serving the Dover Township area, New Jersey: Field-data collection activities and water-distribution system modeling. Atlanta: Agency for Toxic Substances and Disease Registry.
- Maslia, ML, Sautner, JB, Aral, MM, Reyes, JJ, Abraham, JE, and Williams, RC. 2000. Using water-distribution system modeling to assist epidemiologic investigations. American Society of Civil Engineers Journal of Water Resources Planning and Management, 126(4):180–98.
- Maslia, ML, Sautner, JB, Aral, MM, Gillig, RE, Reyes, JJ, and Williams, RC. 2001. Historical reconstruction of the water-distribution system serving the Dover Township area, New Jersey: January 1962–December 1996. Atlanta: Agency for Toxic Substances and Disease Registry.
- Rossman, LA. 2000. EPANET 2 users manual. Cincinnati (OH): US Environmental Protection Agency, National Risk Management Research Laboratory.

ILLUSTRATIONS

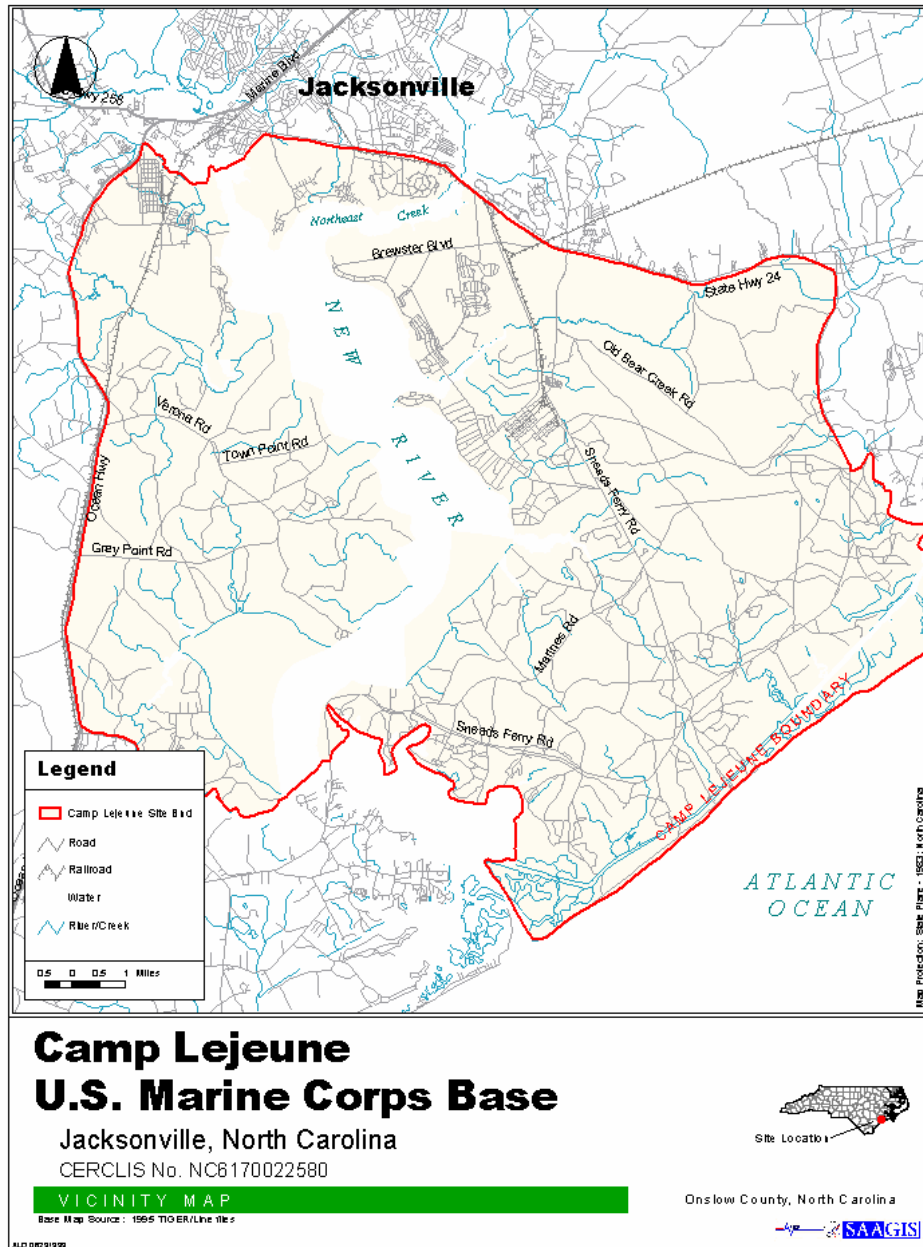

Figure 1. Location of study area

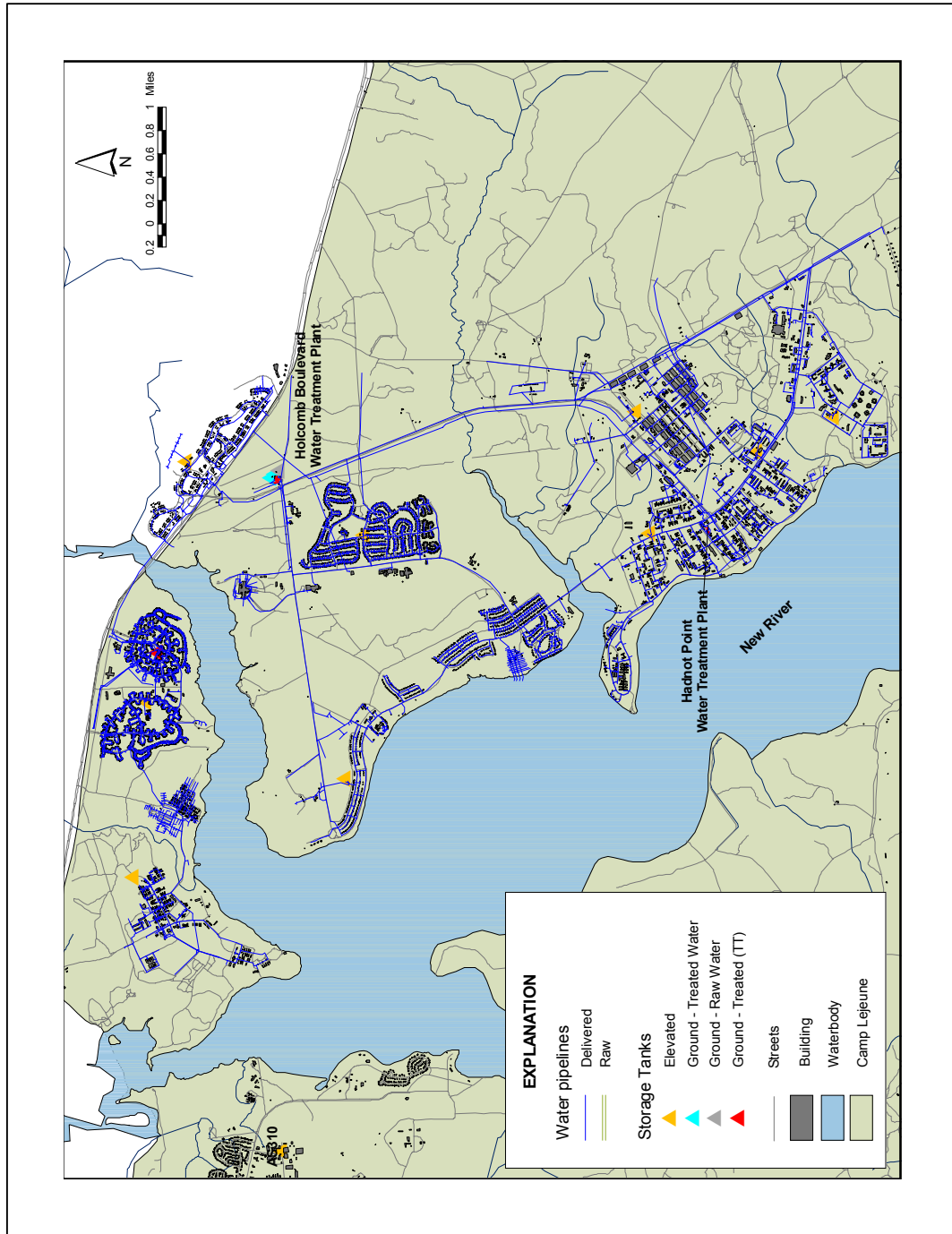

Figure 2. Location of Hadnot Point and Holcomb Boulevard water-distribution systems.

Draft Work Plan – Preliminary Test–Hadnot Point Water-Distribution System

Figure 2

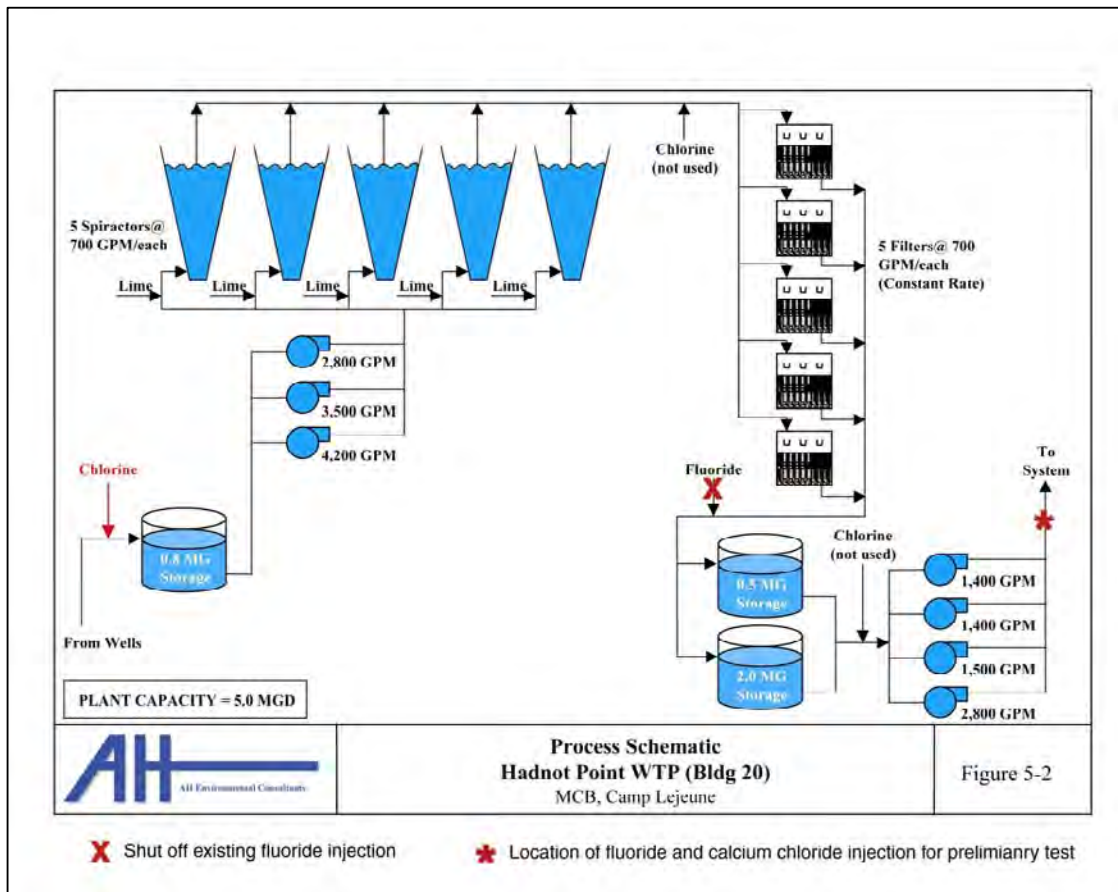

Figure 3. Location of fluoride and calcium chloride injection at the Hadnot Point water treatment plant for preliminary test.

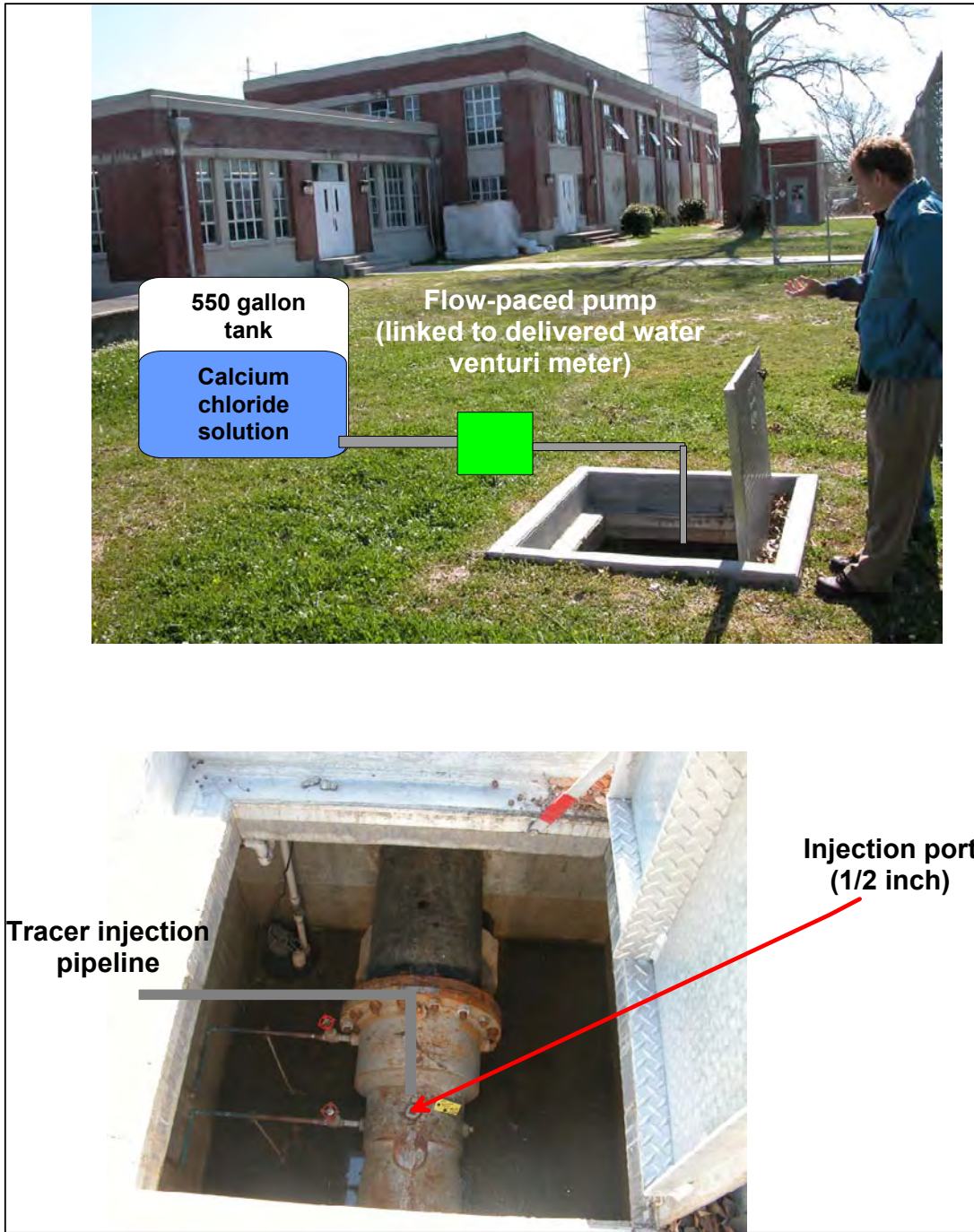

Figure 4. Photographs showing location of tracer injection and generalized schematic of injection apparatus for tracer study of Hadnot Point water-distribution system.



Figure 5. Photographs showing calcium chloride solution to be used for tracer study of the Hadnot Point water-distribution system: (A) 55-gal drums, and (B) label showing 35% by weight.



Figure 6. Photograph showing sampling hydrant F03 marker flag mounted on 5-foot fiberglass pole (refer to Plate 1 and Appendix F for hydrant location).

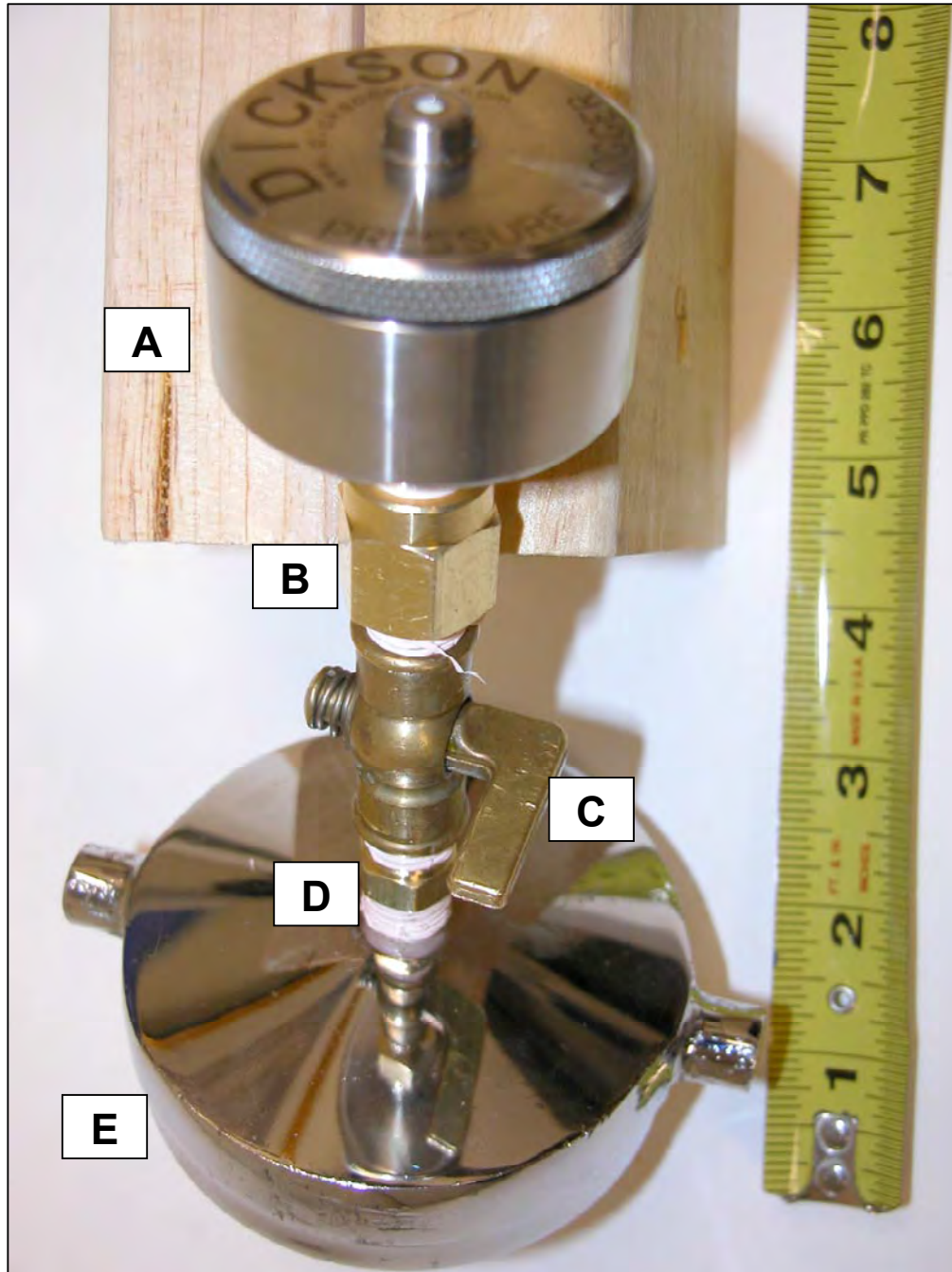

Figure 7. Photograph showing: (A) Dixon PR300 continuous recording pressure data logger, (B) Dixon R022 filter kit (1/4 NPT x 1/4 NPTF), (C) Dixon brass lever handle shut-off valve (1/4 NPTF x 1/4 NPTF) in off position, (D) Hofmann brass nipple (1/4 NPT x 1/4 NPT), and (E) Dixon A7983 hydrant adapter kit.

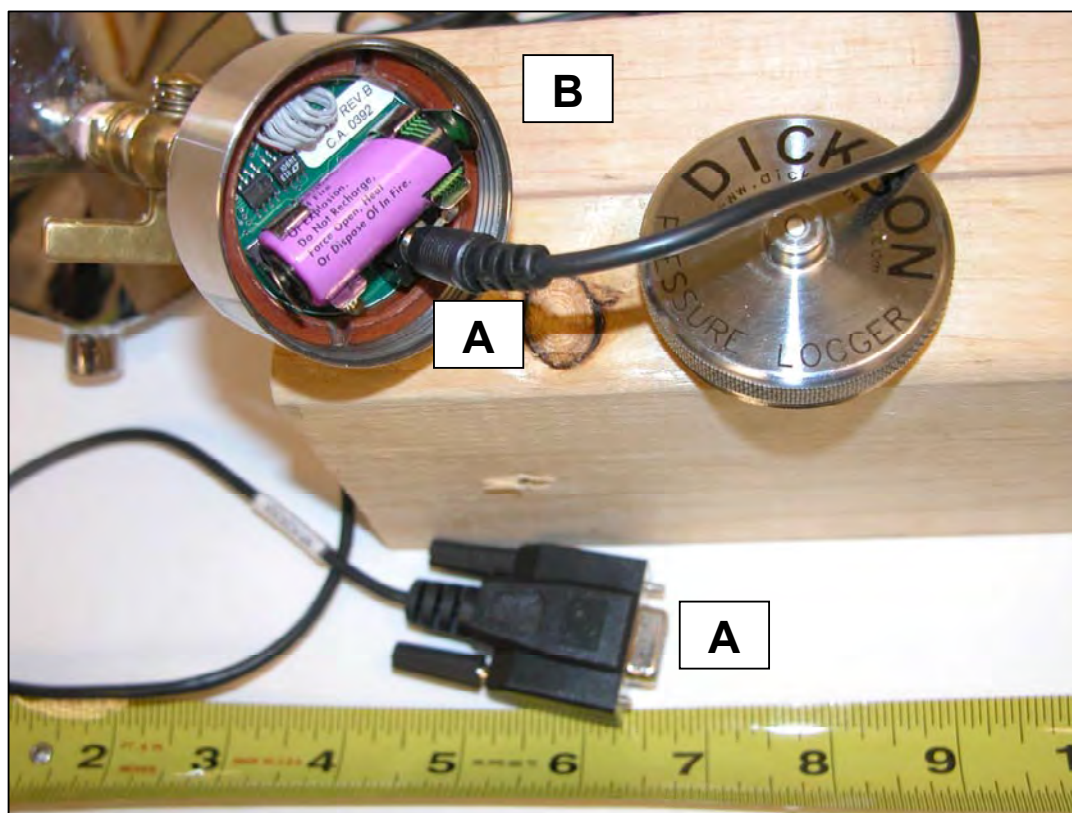

Figure 8. Photograph showing: (A) nine-pin standard computer cable, and (B) Dixon PR300 continuous recording pressure gauge.

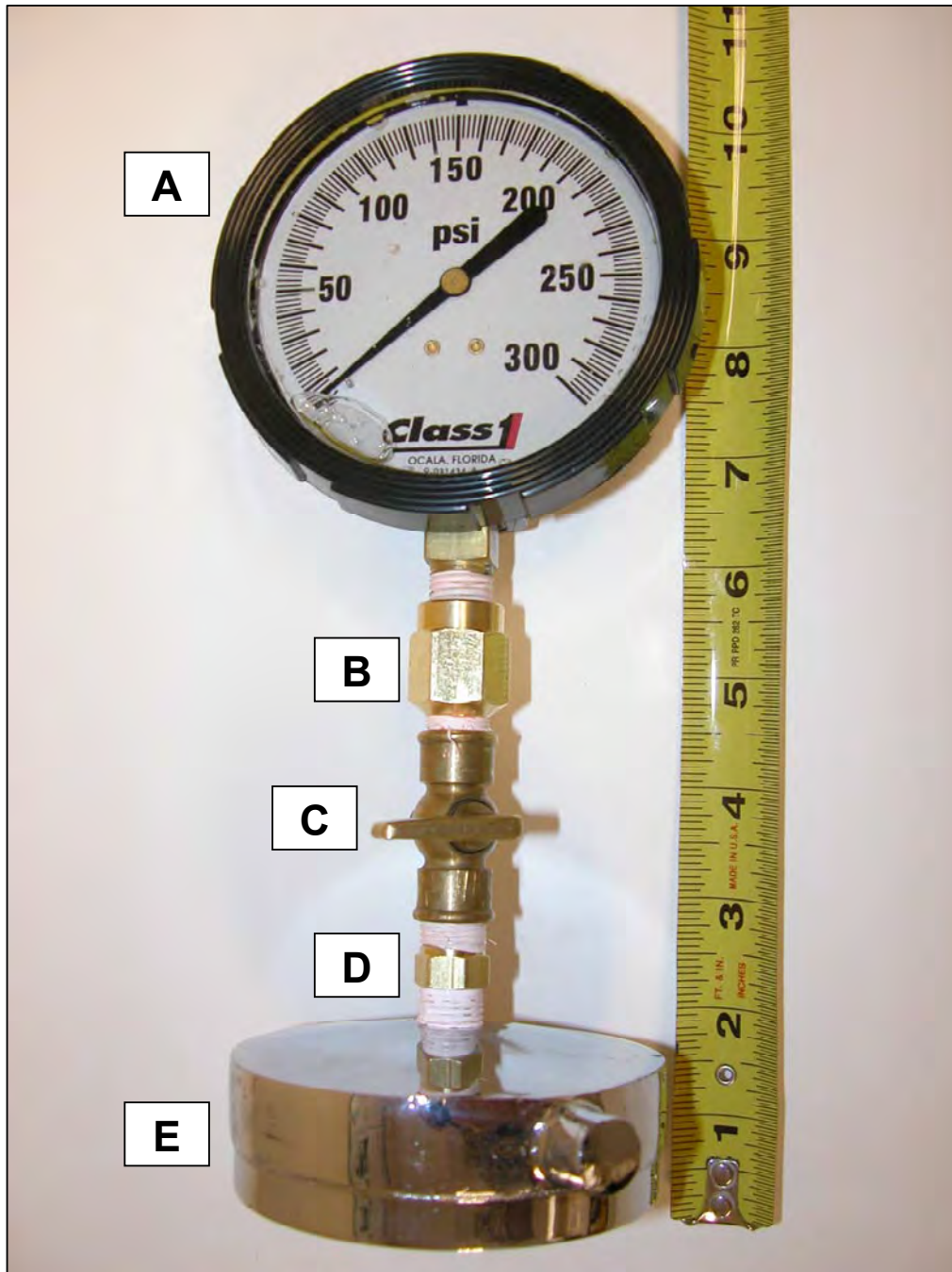

Figure 9. Photograph showing: (A) Class 1 hand-held pressure gauge, (B) Dixon R022 filter kit (1/4 NPT x 1/4 NPTF), (C) Dixon brass lever handle shut-off valve (1/4 NPTF x 1/4 NPTF) in off position, (D) Hofmann brass nipple (1/4 NPT x 1/4 NPT), and (E) Dixon A7983 hydrant adapter kit.



Figure 10. Photograph showing HORIBA W-23XD dual probe ion detector with: (A) fluoride and chloride sensors, and (B) pH, temperature, and conductivity sensors (located inside metal housing).

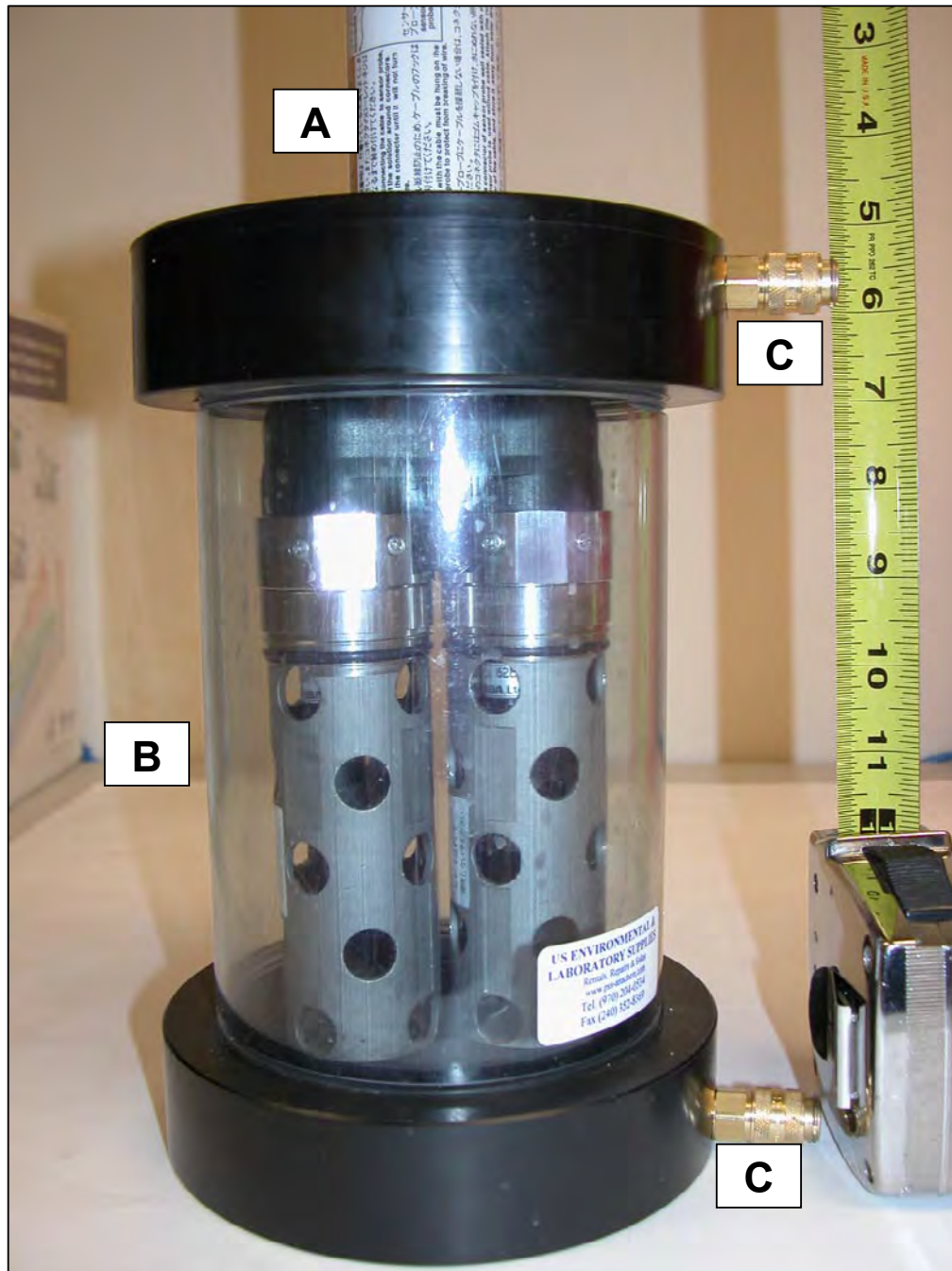

Figure 11. Photograph showing: (A) HORIBA W-23XD dual probe ion detector, (B) flow cell with (C) Rectus 21KANNMPX, 1/4 NPT brass connectors.

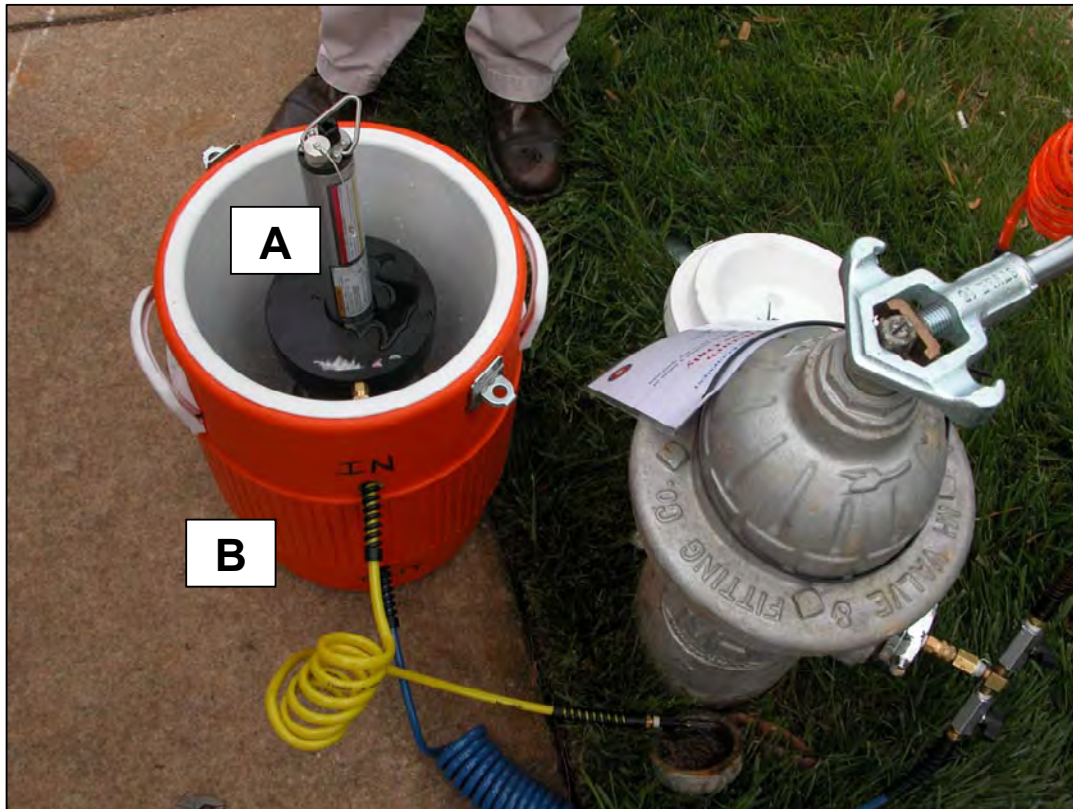

Figure 12. Photograph showing: (A) HORIBA W-23XD dual probe ion detector and flow cell housed in (B) protective 5-gallon plastic water jug.

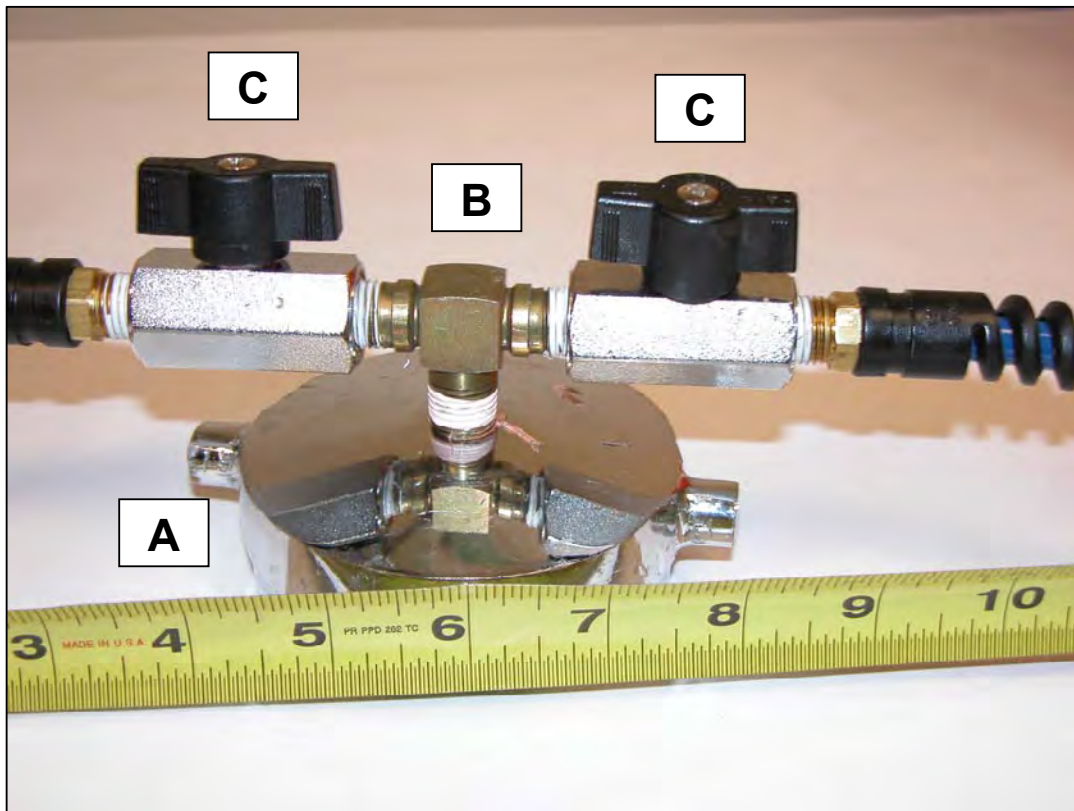

Figure 13. Photograph showing: (A) Dixon A7893 hydrant adapter kit, (B) 1/4 NPT brass “T”, and (C) 1/4 NPTF ball valves.

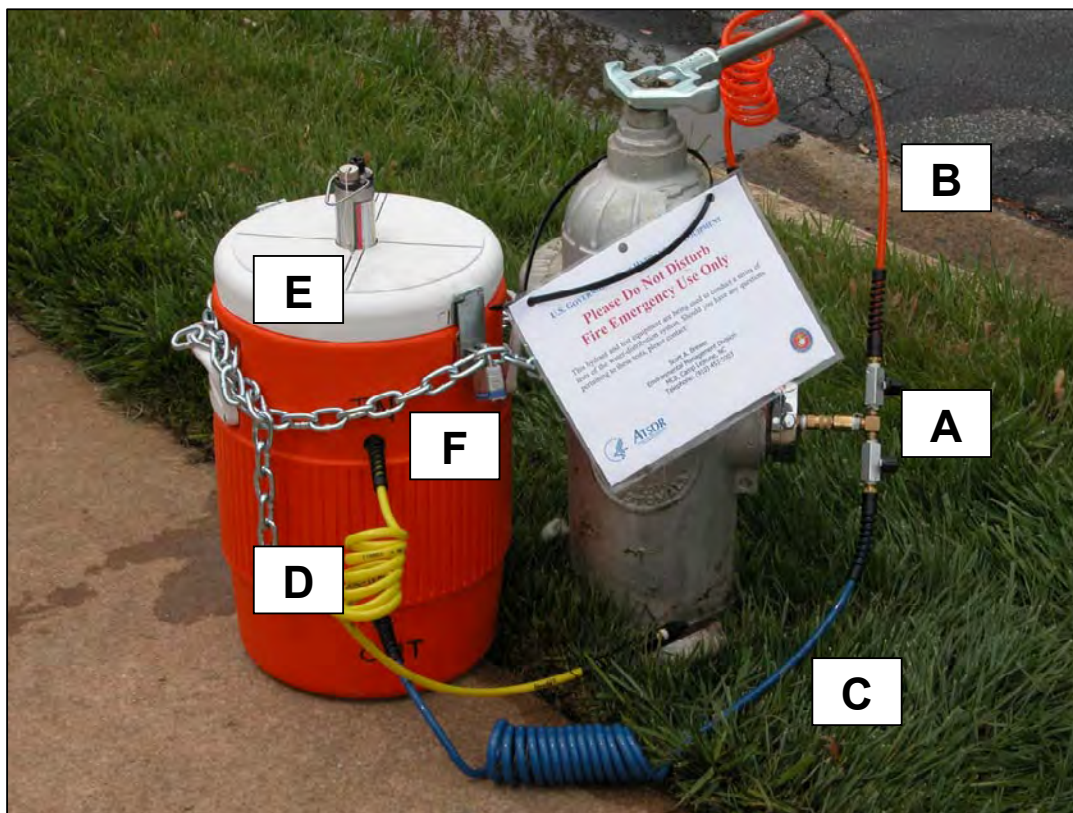

Figure 14. Photograph showing: (A) hydrant adapter kit, bass “T”, and ball valve configuration, (B) Rectus PSCH0605-16, 5-foot orange hose for collecting grab sample, (C) Rectus PSCH0610-3, 10-foot blue hose for supplying flow cell with hydrant water, (D) Rectus PSCH0605-5, 5-foot yellow hose for discharging water from flow cell, (E) 5-gallon protective plastic water jug housing the HORIBA W-23XD dual-probe ion detector and flow cell, and (F) chain and lock securing equipment to hydrant.



Figure 15. Photograph showing HORIBA W-23XD water-quality control unit and cable attached to dual probe ion detector housed in a protective plastic 5-gallon water jug.

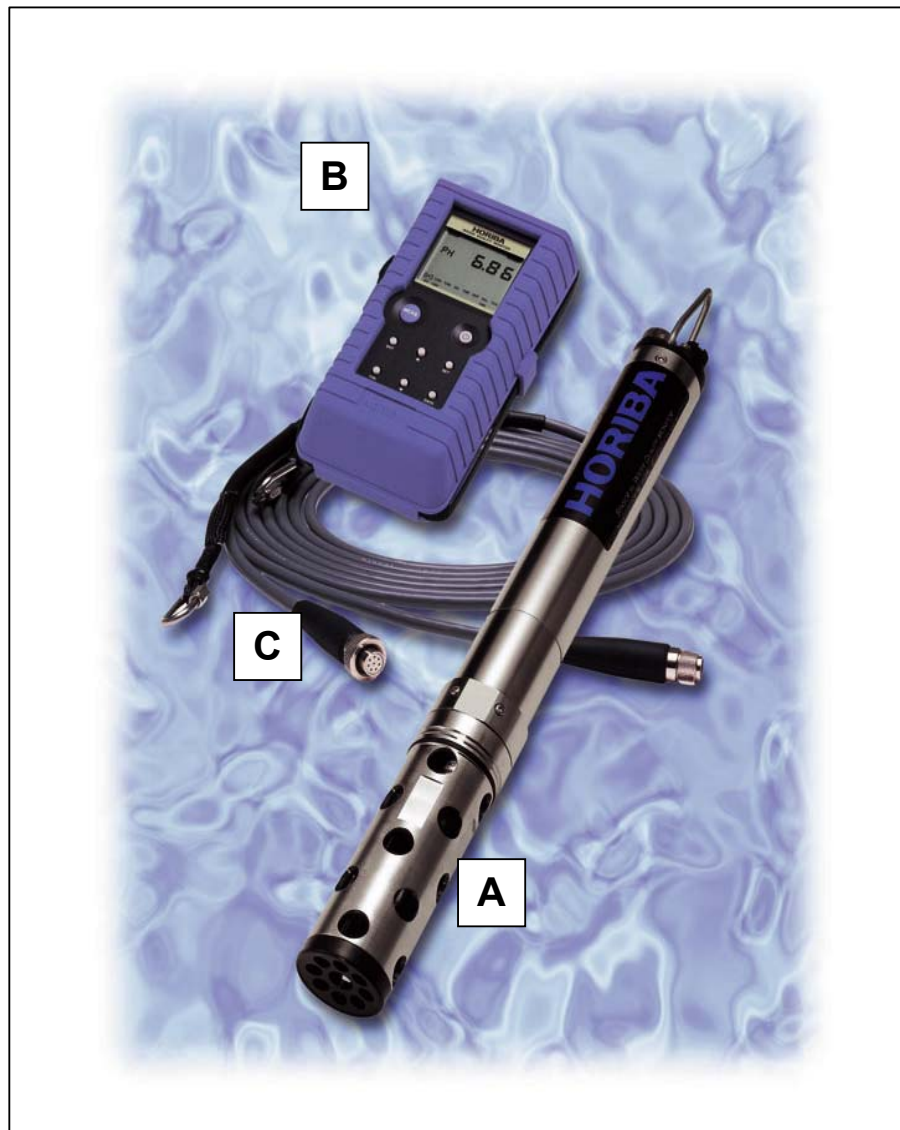

Figure 16. Photograph showing: (A) HORIBA W-21XD single probe water-quality measurement logger, (B) control unit for downloading data from logger, and (C) cable to connect control unit to probe.

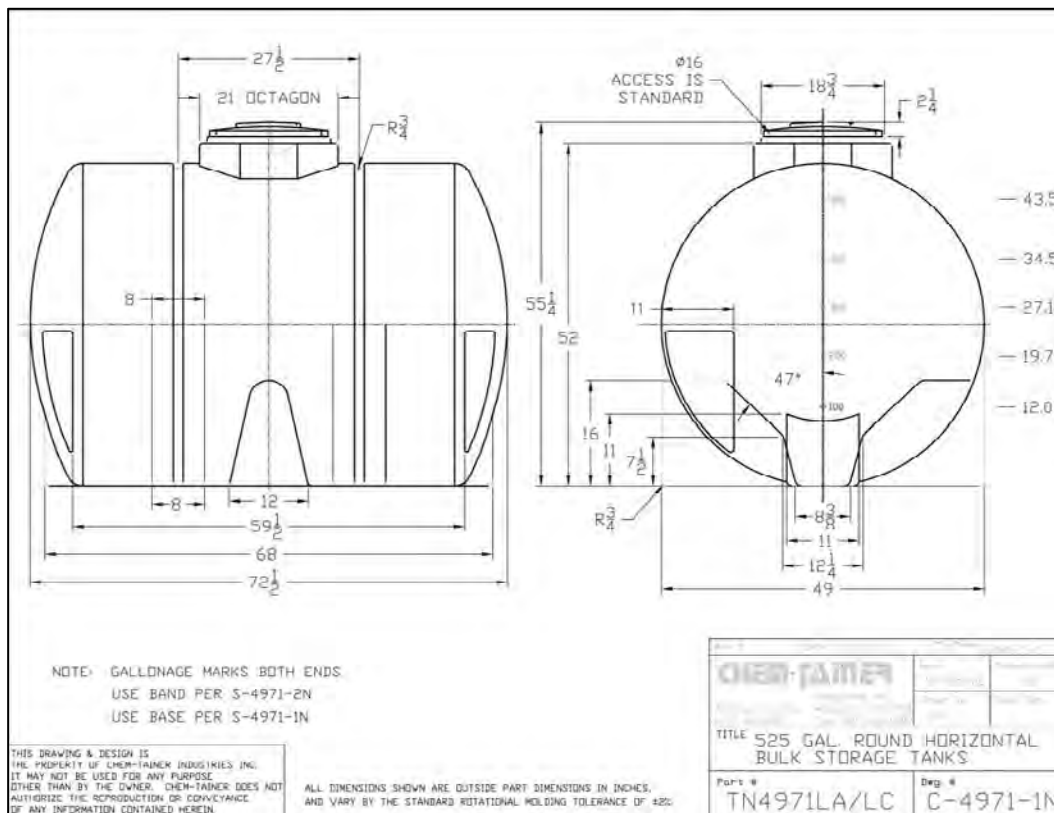

Figure 17. Picture and schematic of 525-gallon storage tank used to store calcium chloride (CaCl₂) solution for tracer test.

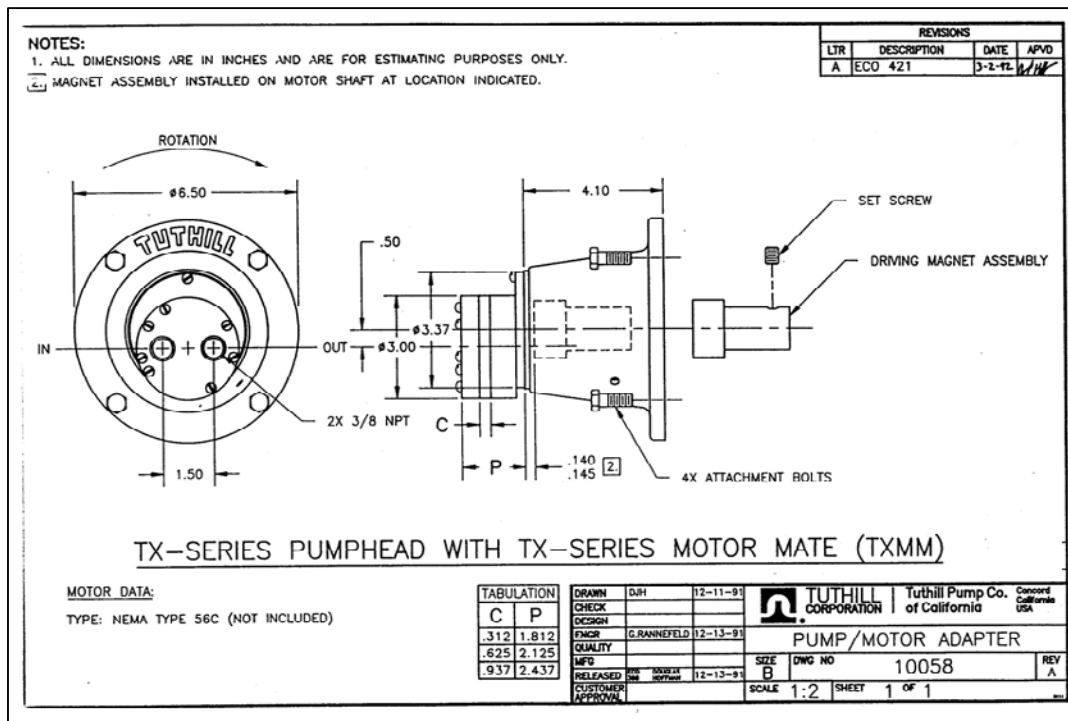

Figure 18. Schematic of Tuthill TX-series pump for calcium chloride (CaCl₂) solution tracer injection.

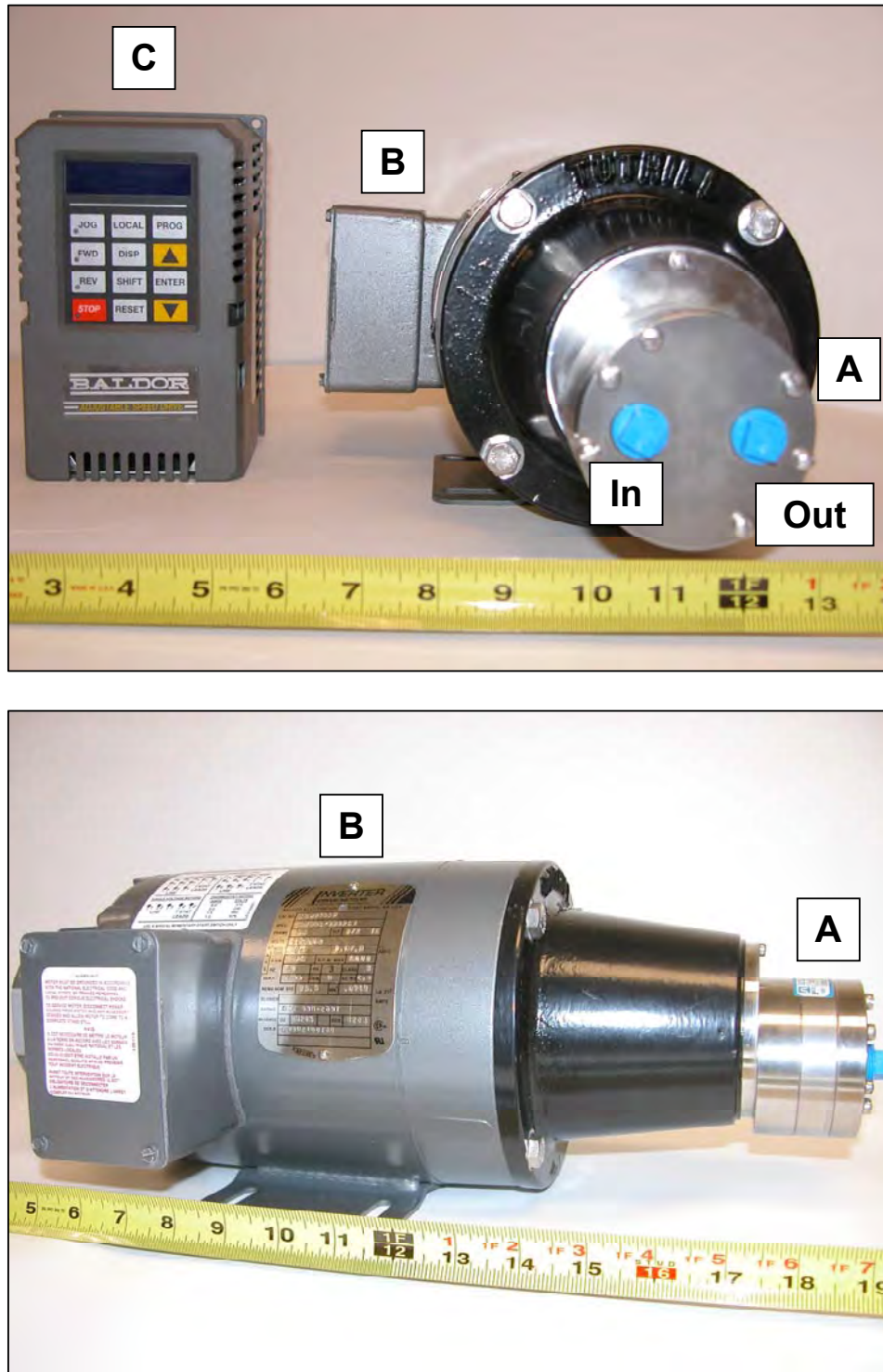

Figure 19. Photographs showing : (A) Tuthill TX-series pump, (B) Baldor ½-horsepower inverter motor, and (C) controls for picking up 4-20 milliamp signal.

(A)

LMI Fluoride Saturator

- Fluoridate water flows to 10,000 gpm
- Continuous duty, low maintenance design
- For use with sodium fluoride

The LMI fluoride saturator provides an easily maintained source of saturated sodium fluoride solution. The unit is designed for efficiency, economy, ease of installation, and minimal maintenance. The tank cover of the unit houses the saturator components, including solenoid valve, siphon breaker, and liquid level switch. A push-button light switch allows for visual inspection of fluoride bed level. The integrally mounted liquid level switch controls solenoid valve operation to maintain a proper solution level in the tank. The distributor tube assembly supplies fresh water to a bed of sodium fluoride at tank bottom. Water dispersed by the distributor tubes flows up through the sodium fluoride powder/crystals to provide a saturated (4%) solution.

The 50-gallon tank is UV light resistant, yellow polyethylene, with tapered sides, 5-gallon graduations, and installed overflow connection. LMI metering pumps can be conveniently mounted in the recess provided on the saturator cover assembly. Series 1 pumps can be used for addition of sodium fluoride with constant water flow rate applications. Series 7 or 9 pumps can be used for applications requiring pump output to change proportionally with varying water flow rate applications.

Saturator includes tank, cover assembly, distributor tube assembly and 10 feet of $\frac{3}{8}$ " O.D. polyethylene water inlet tubing. Shipping weight is 37 lbs.

(B)



LMI Series A9, B9 & C9 Pumps

- LMI's most advanced pumps – flexible programming
- Accept 4-20 mA or pulse signals

LMI's Series 9 microprocessor controlled pumps feature a 4-key keypad for programming and manual control of pump speed. Speed is adjustable from 1 stroke/hour to 100 strokes/minute. In external mode, pump will accept 4-20 mA or pulse signals. The 4-20 mA response is scalable and the pump can be programmed to respond to the 4-20 mA signal directly or inversely for maximum flexibility. Two pulse modes are available; pulse divide and pulse multiply. Pulse divide allows the pump to respond with a pre-programmed amount of strokes for every 1 to 999 incoming pulses. In pulse multiply mode, the pump can be programmed to stroke from 1 to 999 times for every incoming pulse. Stroke length is adjusted using the dial located in the center of the panel. Remote on/off and low-level shutoff inputs are standard, allowing you to shut off the pump automatically when there is no flow in the process stream or when your chemical day tank is empty. The adjustable pressure control reduces discharge pulsation and extends pump life. A rugged, totally enclosed, chemically resistant housing protects pumps in the harshest environments. Encapsulated electronics and a rigid housing and stroke bracket ensure years of precise, repeatable performance.

Pumps include 4-function discharge valve (anti-siphon, pressure relief, back pressure, priming), injection valve, suction valve, foot valve/strainer, 16' polyethylene suction and discharge tubing. Repair kits include replacement diaphragm, seals, 4 pump head screws and check valves.

Figure 20. Fluoride injection system for Handot Point tracer study: (A) LMI 50-gallon saturator kit, and (B) LMI chemical feed pump and flow controller for picking up 4-20 milliamp signal.

Draft Work Plan – Preliminary Test–Hadnot Point Water-Distribution System

Figure 20



Figure 21. Photographs showing training session at ATSDR facilities on installation, calibration, and use of HORIBA W-23XD water-quality monitoring system, April 21, 2004.



Figure 22. Photograph showing 25-unit first aid kit.



Figure 23. Photograph showing outdoor skin protection kit .

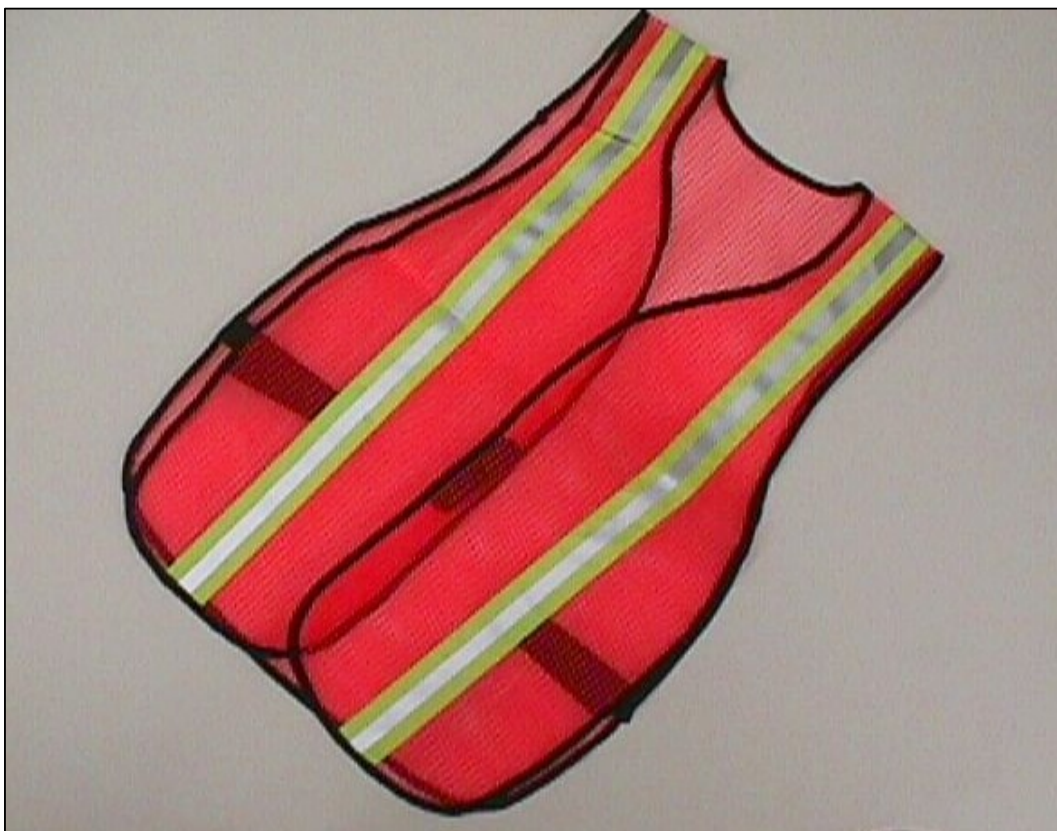

Figure 24. Photograph showing orange fluorescent safety vest to be worn by tracer study team members.

TABLES

Table 1. Pressure measurements for selected test hydrants, Hadnot Point water-distribution system, April 19, 2004 (see Plate 1 for hydrant locations). [psi, pounds per square inch]

| Hydrant Identification | Time (hours) | Pressure (psi) |
|-------------------------------|---------------------|-----------------------|
| P01 | 13:45 | 60 |
| P02 | 14:23 | 60 |
| P03 | 15:15 | 60 |
| P04 | 15:30 | 65 |
| P05 | 15:47 | 60 |
| P06 | 16:15 | 60 |
| P07 | 16:48 | 59 |
| P08 | 17:48 | 59 |
| P09 | 17:55 | 58 |

Table 2. Water-distribution system data collection methods, Hadnot Point water-distribution system, Marine Corps Base, Camp Lejeune, North Carolina.

[QA/QC, quality assurance and quality control; SCADA, supervisory control and data acquisition]

| Parameter | Collection Method | Notes |
|---|--|---|
| Pressure | Continuous recording data logger; 15-minute interval | Dixon PR300 pressure logger; 9 locations– refer to Plate 1 and Appendix F for locations; QA/QC using hand gauge |
| Hydraulic head | SCADA system records for water-level in storage tanks during test; 15-minute interval | If SCADA unavailable, manual recording of water-level in elevated storage tanks by ATSDR staff in control rooms |
| Groundwater well supply | SCADA system records for groundwater supply well pumpage during test; 15-minute interval | If SCADA unavailable, manual recording of groundwater well pumpage by ATSDR staff in control rooms |
| Flow from raw water pumps and treated water booster pumps | SCADA system records for pump flows during test; 15-minute interval | If SCADA unavailable, manual recording of pump flows by ATSDR staff in control rooms |
| System operation procedures (on/off cycling of wells and pumps) | Operator system records for on/off cycling events; | Manual recording on/off cycling events by ATSDR staff in control room |
| Fluoride concentration | Continuous recording data logger; 15-minute interval | HORIBA W-23XD dual ion probe logger, 9 locations– Plate 1 and Appendix F for locations; QA/QC using grab samples |
| Chloride concentration | Continuous recording data logger; 15-minute interval | HORIBA W-23XD dual ion probe logger, 9 locations– Plate 1 and Appendix F for locations; QA/QC using grab samples |
| Conductivity | Continuous recording data logger; 15-minute interval | HORIBA W-23XD dual ion probe logger, 9 locations; HORIBA W-21XD single probe logger; 9 locations– Plate 1 and Appendix F for locations; QA/QC using grab sample |

Table 3. Schedule of preliminary test activities, Hadnot Point water-distribution system, Marine Corps Base, Camp Lejeune, North Carolina, May 17–27, 2004.

[ATSDR, Agency for Toxic Substances and Disease Registry; CL, Camp Lejeune water-utility staff; HP, Hadnot Point, WTP, water treatment plant; QA/QC, quality assurance and quality control]

| Date | Time (Hours) | Activity | Responsible Staff |
|--------|--------------|--|------------------------|
| May 17 | 0800 | Setup and installation of injection pumps on grounds of HP WTP | CL; ATSDR ¹ |
| | 0800–1600 | Install pressure and water-quality monitoring equipment on all test hydrants (refer to Plate 1 for locations) | ATSDR |
| | 1600 | Shut off fluoride feed at HP WTP | CL |
| May 18 | 0800–1600 | Calibrate injection pumps to delivered water flow rate | CL; ATSDR |
| | 0800–1600 | QA/QC pressure and water-quality monitoring equipment (refer to Plate 1 for locations) | ATSDR |
| May 19 | 0800–1200 | QA/QC injection pumps | CL; ATSDR |
| | 0800–1200 | QA/QC pressure and water-quality monitoring equipment (refer to Plate 1 for locations) | ATSDR |
| May 24 | 0800 | Begin calcium chloride injection | ATSDR ² |
| | 0800–2200 | QA/QC pressure and water-quality monitoring equipment (refer to Plate 1 for locations); lab analysis of grab samples | ATSDR |
| | 1400 | Shut off calcium chloride injection | ATSDR |
| May 25 | 0800 | Begin fluoride injection | ATSDR |
| | 0800–2200 | QA/QC pressure and water-quality monitoring equipment (refer to Plate 1 for locations); lab analysis of grab samples | ATSDR |
| | 1400 | Shut off fluoride injection | ATSDR |
| May 26 | 0800–2200 | QA/QC pressure and water-quality monitoring equipment (refer to Plate 1 for locations); lab analysis of grab samples | ATSDR |
| May 27 | 0800 | Disassemble injection pump equipment | CL |
| | 0800–1400 | Remove data loggers from hydrants and retrieve data from loggers | ATSDR |
| | 1400–1600 | HP tracer study concludes; post-test discussions with Camp Lejeune staff | CL; ATSDR |

¹ Only 3 ATSDR staff required, May 17–19.² Nine ATSDR staff require for test, refer to Table 4 for specific duties and responsibilities of ATSDR staff.

Table 4. Duties and responsibilities of ATSDR staff during tracer study test, Hadnot Point water-distribution system, Marine Corps Base, Camp Lejeune, North Carolina, May 24–27, 2004.

| Date | Time | Test Activity and ATSDR Test Staff Assignments ¹ | | | | | |
|--------|------------------------|---|-----------------|------------------------|------------------|------------------|----------------------|
| | | Control Room | Injection Pumps | Water-Quality Analyses | Pressure Loggers | Fluoride Loggers | Conductivity Loggers |
| May 24 | 0800–1400 | #5 | #5 | #3, #6 | #6 | #1, #2, #4 | #7, #8, #9 |
| | 1400–2200 | #5 | Pump off | #1, #6 | #6 | #2, #3, #4 | #7, #8, #9 |
| | 2200–2400 | #6 | Pump off | | | | |
| May 25 | 0800–1400 | #2 | #2 | #9, #6 | #6 | #1, #3, #4 | #5, #7, #8 |
| | 1400–2200 | #2 | Pump off | #1, #6 | #6 | #3, #4, #9 | #5, #7, #8 |
| | 2200–2400 | #6 | Pump off | | | | |
| May 26 | 0800–1200 | #5 | | #3, #6 | #6 | #1, #2, #4 | #5, #7, #8 |
| | 1200–1600 | #6 | | #2, #9 | #6 | #2, #3, #4 | #5, #7, #8 |
| | 1600–2400 | #2 | | | | | |
| May 27 | 0800–1400 ² | | #5, #6 | | #2, #4, #8 | #2, #4, #8 | #2, #4, #8 |

¹ Not all ATSDR test staff are employed by ATSDR, but for the purpose of this document and the test, they will be referred to as ATSDR staff. Test staff and their affiliations are as follows: #1: M. Cienek, U.S. Geological Survey, Raleigh, North Carolina; #2: R.E. Faye, Eastern Research Group, Boston, Massachusetts; #3: A.B. Funk, National Center for Environmental Health, Centers for Disease Control and Prevention, Atlanta, Georgia; #4: G.C. Mayer, U.S. Geological Survey, Norcross, Georgia; #5: M. Martinson, ATSDR, Atlanta, Georgia; #6: M.L. Maslia, ATSDR, Atlanta, Georgia; #7: C. Pfeifle, U.S. Geological Survey, Raleigh, North Carolina; #8: J.B. Sautner, ATSDR, Atlanta, Georgia; #9: C. Valenzuela, Georgia Institute of Technology, Atlanta, Georgia.

² Injection equipment disassembled, loggers are removed from hydrants, and data retrieved from loggers, refer to Table 3.

APPENDICES

APPENDIX A

Chemical Mass Balance Computations for Calcium Chloride (CaCl₂) Solution

Notation

MW = molecular weight

$[CaCl_2]_i, [Cl]_i$ = injection concentration at the pump

ΔCl_d = Cl concentration increase in delivered water during test

$[Cl]_d$ = Cl concentration in delivered water

Q = water demand

q = injection pump flow rate

General data

$MW CaCl_2$ = 110.99 g/mol

$MW Cl$ = 35.45 g/mol

$CaCl_2$ solubility = 755 g/L (equivalent to 482 g/L of Cl)

$CaCl_2$ %w/w = 35%

$CaCl_2$ relative density @ 20°C = 1.3374 kg/L

 Cl standard

Maximum $[Cl]_d$ concentration during test (estimated) = 200 mg/L (**EPA secondary standard is 250 mg/L**)

Background Cl concentration = 20 mg/L (Data from Hadnot Point delivered water)

Maximum allowable Cl increase during test ΔCl_d = 180 mg/L

Tracer test (targeting 200 mg/L)

Demand (estimated) Q = 3 MGD = 125,000 gph

Injection pump flow rate (estimated) q = 60 gph

$CaCl_2$ concentration $[CaCl_2]_i$ = 588 g/L

Cl concentration $[Cl]_i$:

$$[Cl]_i = [CaCl_2]_i \cdot \frac{MWCl}{MWCaCl_2} \cdot \frac{2 \frac{eq}{molCaCl_2}}{1 \frac{eq}{molCl}} \quad (1)$$

$[Cl]_i$ = 375.6 g/L (eq. 1)

Cl concentration increase in delivered water ΔCl_d :

$$\Delta Cl_d = \frac{q[Cl]_i}{q+Q} \quad (2)$$

ΔCl_d = 180 mg/L (eq. 2)

$[Cl]_d$ = 20+180 = 200 mg/L

Tracer test (considering 35%w/w $CaCl_2$ solution)

Demand (estimated) $Q = 3$ MGD = 125,000 gph

Injection pump flow rate (estimated) $q = 60$ gph

$CaCl_2$ concentration in drums = $0.35\text{g/g} \times 1.3374\text{ kg/L} \times 1000\text{ g/kg} = 468.09\text{ g/L}$

$CaCl_2$ concentration $[CaCl_2]_i = 468.09\text{ g/L}$

$[Cl]_i = 299\text{ g/L}$ (eq. 1)

$\Delta Cl_d = 144\text{ mg/L}$ (eq. 2)

$[Cl]_d = 20 + 144 = 164\text{ mg/L}$

 $CaCl_2$ Injection Time

500 gallons / 60 gph = 8.3 hours to empty the tank

Drums of $CaCl_2$ Required

Volume of $CaCl_2$ (35 %w/w) = 500 gal

Volume of drum $CaCl_2$ (35 %w/w) = 55 gal

Drums of $CaCl_2$ (35 %w/w) required = $500\text{ gal} / 55\text{ gal/drum} \approx 9$ drums

APPENDIX B

Material Safety Data Sheet (MSDS) for Calcium Chloride (CaCl₂) Solution



Calcium Chloride Solution

This MSDS Sheet complies with the style format specified by ANSI Z400 1-1993

SECTION 1: CHEMICAL PRODUCT - COMPANY IDENTIFICATION

TETRA Technologies, Inc. (281) 367-1983
 25025 I-45 North (800) 327-7817
 The Woodlands, Texas 77380

(800) 424-9300 CHEMTREC (24 Hour Emergency Response)
(800) 222-1222 POISON CONTROL

SUBSTANCE: Calcium Chloride, Solution
TRADE NAMES/SYNONYMS: Liquid Calcium Chloride, Road Master™, Superset™, Food Grade Liquid Calcium Chloride
CHEMICAL FAMILY: Inorganic Salt
MSDS CREATION DATE: 01 MAR 94
MSDS REVISION DATE: 9 JUL 02

SECTION 2: COMPOSITION, INFORMATION ON INGREDIENTS

| COMPONENTS | CAS NUMBER | RTECS NUMBER | PERCENTAGE |
|------------------|------------|--------------|------------|
| Calcium Chloride | 10043-52-4 | EV9800000 | 20 – 45% |
| Water | | | 55 – 80% |

PROBABLE CONTAMINANTS: Calcium Carbonate, Calcium Hydroxide, Calcium Oxide, Alkali Metal Chlorides, Alkaline Earth Metal Chlorides

SECTION 3: HAZARDS IDENTIFICATION

NFPA RATINGS: (SCALE 0-4): HEALTH=1 FIRE=0 REACTIVITY=0
EMERGENCY OVERVIEW: Odorless, clear to amber liquid. May cause skin, respiratory tract, and eye irritation.
POTENTIAL HEALTH EFFECTS:
INHALATION, SKIN CONTACT, EYE CONTACT: May cause minor irritation.
INGESTION: May cause nausea.

SECTION 4: FIRST AID MEASURES

SKIN CONTACT: Remove contaminated clothing and shoes. Wash affected area with soap or mild detergent.
EYE CONTACT: Flush eyes with water or normal saline solution.
INGESTION: Get medical attention.

SECTION 5: FIRE FIGHTING MEASURES

FIRE AND EXPLOSION HAZARD: Negligible fire hazard.
HAZARDOUS COMBUSTION PRODUCTS: Not applicable.

SECTION 6: ACCIDENTAL RELEASE MEASURES

OCCUPATIONAL SPILL: For small spills, take up with sand or other absorbent material and place in containers for disposal. For larger spills, dike far ahead of spill for later disposal.



Calcium Chloride Solution

This MSDS Sheet complies with the style format specified by ANSI Z400 1-1993

SECTION 7: HANDLING AND STORAGE

Observe all federal, state and local regulations when storing this product. Store in a tightly closed container. Store away from incompatible materials.

SECTION 8: EXPOSURE CONTROLS, PERSONAL PROTECTION

EXPOSURE LIMITS: No occupational exposure limits established by OSHA/ACGIH/NIOSH.
VENTILATION: Provide local exhaust ventilation system.
EYE PROTECTION: Wear safety glasses with splash shields or safety goggles/shield.
CLOTHING: Wear normal work clothing. Leather work boots and/or leather products will dehydrate with resultant shrinkage and possible destruction.
GLOVES: Wear appropriate protective gloves.

SECTION 9: PHYSICAL AND CHEMICAL PROPERTIES

DESCRIPTION: Odorless, clear to amber liquid.
MOLECULAR FORMULA: CaCl_2
MOLECULAR WEIGHT: 110.99 (for pure CaCl_2)
BOILING POINT: 118°C (244°F) for 38% solution
SPECIFIC GRAVITY: 1.376 @ 25°C (77°F) for 38% solution
pH: 3.8 - 9.0
WATER SOLUBILITY: Miscible with water in all proportions.
SOLVENT SOLUBILITY: Miscible in alcohol, acetic acid and acetone

SECTION 10: STABILITY AND REACTIVITY

REACTIVITY: Stable under normal temperatures and pressures.
INCOMPATIBILITIES: Strong oxidizing agents.
HAZARDOUS DECOMPOSITION: None, under normal conditions.
POLYMERIZATION: Does not occur under normal temperatures and pressures.
CONDITIONS TO AVOID: None

SECTION 11: TOXICOLOGICAL INFORMATION

TOXICITY DATA (ANHYDROUS CALCIUM CHLORIDE):
 TD_{Lo}: 112g/kg, oral, 20 weeks, rat
 LD_{Lo}: 274 mg/kg, subcutaneous, dog
 LD₅₀: 1000 mg/kg, oral, rat
 LD₅₀: 264 mg/kg, intraperitoneal, rat
 Mutagenic data and tumorigenic data—see Registry of Toxic Effects of Chemical Substances (RTECS) file.
CARCINOGEN STATUS: None.
LOCAL EFFECTS: Eye, mucous membrane and skin irritant.
ACUTE TOXICITY LEVEL: Moderately toxic by ingestion, slightly toxic by dermal absorption.

SECTION 12: ECOLOGICAL INFORMATION

DEGRADABILITY: Product will not biodegrade or bioaccumulate.

SECTION 13: DISPOSAL INFORMATION

Observe all federal, state and local regulations when disposing of this substance.



Calcium Chloride Solution

This MSDS Sheet complies with the style format specified by ANSI Z400 1-1993

SECTION 14: TRANSPORT INFORMATION

DOT Shipping Name-ID Number: Non-regulated.

SECTION 15: REGULATORY INFORMATION

| | |
|-----------------------------------|--|
| TSCA STATUS: | Yes |
| DSL STATUS: | Yes |
| EINECS STATUS: | Yes |
| OTHER TSCA ISSUES: | None |
| CALIFORNIA PROPOSITION 65: | No ingredients found on the Propositions 65 list |
| SARA SECTIONS 311 CLASSIFICATION: | Acute Hazard |

SECTION 16: OTHER INFORMATION

Individuals handling this product should be informed of the recommended safety precautions and should have access to this information.

This information relates to the specific product designated and may not be valid for such product used in combination with any other materials or in any other processes. Such information is to the best of our knowledge and belief, accurate and reliable as of the date compiled. However, no representation, warranty or guarantee is made as to its accuracy, reliability, or completeness. It is the users' responsibility to satisfy themselves as to the suitability and completeness of such information for their own particular use. We do not accept liability for any loss or damage that may occur from the use of this information nor do we offer warranty against patent infringement.

TETRA Technologies, Inc. reserves the right to refuse shipment of this product to any consumer who fails to demonstrate the ability to consistently handle and use it safely and in compliance with all applicable laws, rules and regulations. Such demonstration may require on-site inspection of any or all storage, processing, packaging and other handling systems that come in contact with it.

Customers are responsible for compliance with local, state and federal regulations that may be pertinent in the storage, application and disposal of this product.

APPENDIX C

Chemical Mass Balance Computations for Sodium Fluoride (NaF) Solution

Notation

MW = molecular weight
 $[NaF]_i$, $[F]_i$ = injection concentration at the pump
 $\Delta F_d = F$ concentration increase in delivered water during test
 $[F]_d = F$ concentration in delivered water
 Q = water demand
 q = injection pump flow rate

General data

$MW NaF = 42$ g/mol
 $MW F = 19$ g/mol
 NaF solubility = 42 g/L (equivalent to 19 g/L of F)

F standard

Maximum $[F]_d$ concentration during test (estimated) = 2.0 mg/L
 Background F concentration (estimated) = 0.2 mg/L (based on 7 day shut off of HP Fluoride treatment)
 Maximum allowable F increase during test $\Delta F_d = 1.8$ mg/L

Tracer test

Demand (estimated) $Q = 3$ MGD = 125,000 gph
 Injection pump flow rate (estimated) $q = 60$ gph
 NaF concentration $[NaF]_i = 8.5$ g/L
 F concentration $[F]_i$:

$$[F]_i = [NaF]_i \cdot \frac{MWF}{MWNaF} \quad (1)$$

$$[F]_i = 3.8 \text{ g/L (eq. 1)}$$

F concentration increase in delivered water ΔF_d :

$$\Delta F_d = \frac{q[F]_i}{q + Q} \quad (2)$$

$$\Delta F_d = 1.8 \text{ mg/L (eq. 2)}$$

$$[F]_d = 0.2 + 1.8 = 2.0 \text{ mg/L}$$

***NaF* required**

$$[NaF]_i = 8.5 \text{ g/L}$$

$$\text{Tank volume } V = 500 \text{ gal}$$

$$NaF \text{ mass required} = 8.5 \text{ g/L} \times 3.78 \text{ L/gal} \times 500 \text{ gal} \times 1 \text{ lb}/453.6 \text{ g} = 35.4 \text{ lb}$$

$$\text{Number of Bags of } NaF \text{ needed @ } 50 \text{ lb/bag} \approx 1 \text{ bag}$$

***NaF* Injection Time**

$$500 \text{ gallons} / 60 \text{ gph} = 8.3 \text{ hours to empty tank}$$

APPENDIX D

Material Safety Data Sheet (MSDS) for Sodium Fluoride (NaF)

Mar 31 04 03:33p

670 WATER PLANT

910-451-3350

p. 2

MATERIAL SAFETY DATA SHEET

HR-670

PAGE 2

BASE MAINTAINANCE Monday, June 30, 2003

02 18 CP/PHIBROCHEM
ONE PARKER PLAZA

TEL# (201) 914-6020
FAX# (201) 914-7911

FORT LEE NJ 07024

***** 24 HOUR EMERGENCY CONTACT: CHEMTREC (800) 424-3300 *****
***** 24 HOUR EMERGENCY CONTACT: COMPANY (803) 481-3528 *****

DATE: 10/15/00 SUPERSEDES: 3/31/99
TRADE NAME: SODIUM FLUORIDE <0218>

1 PRODUCT IDENTIFICATION

NA = NOT APPLICABLE, ND = NOT DETERMINED

| ***** N.F.P.A. ***** | |
|----------------------|-------------------------|
| DEGREE OF HAZARD | EMERGENCY HAZARD RATING |
| 4 = EXTREME | HEALTH < 3 > |
| 3 = HIGH | FIRE < 0 > |
| 2 = MODERATE | REACTIVITY < 0 > |
| 1 = SLIGHT | SPECIFIC HAZARD < > |
| 0 = INSIGNIFICANT | |

TRADE NAME: SODIUM FLUORIDE

FORMULA: NaF

MOLECULAR WT.: 42.00

SYNONYMS: FLORIDINE; SODIUM MONOFLUORIDE; CHEMIFLUOR;
LURIDE-SF; VILLIAUMITE; FLOROCID; LIMOFLUR;
OSSALIN; OSSIN; ZYMAFLUOR; KARIDIUM

Distributed by:
Brenntag Soufless, Inc. - Durham
(919) 598-0881 or 1-800-849-7000

2 INGREDIENTS

| INGREDIENTS (CAS NO.) | WT PCT (APPROX) | PEL | | TLV (TWA) | |
|---------------------------------------|--------------------|-------|-----|-----------|-----|
| | | MG/M3 | PPM | MG/M3 | PPM |
| SODIUM FLUORIDE (7681-49-4) | 90-95 | 2.5* | | 2.5* | |
| SODIUM SILICOFLUORIDE (16893-85-9) | 0-2.5 | 2.5* | | 2.5* | |

* = AS FLUORIDE

THE TLV'S ARE GIVEN FOR GUIDANCE; LOCAL APPLICABLE REGULATIONS SHOULD ALWAYS BE FOLLOWED. INGREDIENTS ARE THOSE PRESENT AT 1% OR GREATER, OR AT 0.1% OR GREATER IF LISTED AS POTENTIAL CARCINOGENS BY

Mar 31 04 03:33p

670 WATER PLANT

910-451-3350

p. 3

MATERIAL SAFETY DATA SHEET
 Monday, June 30, 2003

PAGE 3

OSHA/IARC/NTP. PROPRIETARY INGREDIENT IDENTITIES ARE AVAILABLE IN
 ACCORDANCE WITH 29 CFR 1910.1200.

CARCINOGEN: NTP - NO
 IARC - NO
 OSHA - NO

3 PHYSICAL AND CHEMICAL CHARACTERISTICS

D = DECOMPOSES
 BOILING POINT, 760 MM HG (DEG C): 1700 C (3083 F)
 MELTING/FREEZING POINT (DEG C): 993 C (1819 F)
 SPECIFIC GRAVITY (WATER = 1): 2.558 AT 41 C
 VAPOR PRESSURE (MM HG): 1 AT 1077 C
 VAPOR DENSITY (AIR = 1): ND
 WATER SOLUBILITY (% BY WT): 4 G/100 ML H2O AT 18C
 VOLATILES (% BY WT): NA
 EVAPORATION RATE (BUTYL ACETATE = 1): ND
 PH OF SOLUTION: 7.4

APPEARANCE/ODOR: ODORLESS, WHITE CRYSTALS, OR POWDER. TOXIC!

4 PHYSICAL HAZARD DATA

SODIUM FLUORIDE IS NOT CONSIDERED TO BE A FIRE HAZARD. NOT
 COMBUSTIBLE.

FLASH POINT (DEG C): NA
 TEST METHOD: NA
 FLAMMABLE LIMITS (% BY VOL): NA
 AUTOIGNITION TEMP. (DEG C): NA

EXTINGUISHING MEDIA: USE WATER SPRAY. REMOVE CONTAINERS FROM FIRE
 AREA IF IT CAN BE DONE SAFELY. COOL FIRE EXPOSED CONTAINERS WITH
 WATER SPRAY UNTIL WELL AFTER FIRE IS OUT. DO NOT FLOUGH INTO
 SEWER OR STREAM.

SPECIAL FIRE FIGHTING PROCEDURES: WEAR FULL PROTECTIVE CLOTHING AND
 NIOSH APPROVED SELF-CONTAINED BREATHING APPARATUS WITH FULL
 FACEPIECE OPERATED IN THE PRESSURE DEMAND OR OTHER POSITIVE
 PRESSURE MODE.

UNUSUAL FIRE OR EXPLOSION HAZARDS: NOT CONSIDERED TO BE AN EXPLOSION
 HAZARD. EMITS TOXIC FUMES OF FLUORIDE AND SODIUM OXIDE WHEN
 HEATED TO DECOMPOSITION.

5 REACTIVITY DATA

THERMAL STABILITY: STABLE UNDER ORDINARY CONDITIONS OF USE AND
 STORAGE.

INCOMPATIBILITY: REACTS WITH ACIDS TO FORM HYDROGEN FLUORIDE.

Mar 31 04 03:33p

670 WATER PLANT

910-451-3350

p. 4

MATERIAL SAFETY DATA SHEET

JAINANCE Monday, June 30, 2003
JJJJ

PAGE 4

CORROSIVE TO METALS ESPECIALLY TO ALUMINUM. IN SOLUTION ATTACKS GLASS.

CONDITIONS TO AVOID: EXPOSURE TO INCOMPATIBLES AND HEAT. KEEP AWAY FROM GLASS AND ALUMINUM.

HAZARDOUS POLYMERIZATION: WILL NOT OCCUR.

HAZARDOUS DECOMPOSITION PRODUCTS: EMITS TOXIC FUMES OF FLUORIDES AND SODIUM OXIDE WHEN HEATED TO DECOMPOSITION.

6 HEALTH HAZARD INFORMATION

EFFECTS OF OVEREXPOSURE:

SYMPTOMS OF INGESTION: TOXIC! MAY CAUSE SALIVATION, NAUSEA, VOMITING, DIARRHEA, AND ABDOMINAL PAIN. SYMPTOMS OF WEAKNESS, TREMORS, SHALLOW RESPIRATION, CARDIOPEDAL SPASM, CONVULSIONS, AND COMA MAY FOLLOW. MAY CAUSE BRAIN AND KIDNEY DAMAGE. DEATH MAY OCCUR FROM RESPIRATORY AND CARDIAC FAILURE. LETHAL DOSE: 5-10 GRAMS.

SYMPTOMS OF INHALATION: MAY CAUSE CORROSIVE EFFECTS TO THE RESPIRATORY TRACT. SYMPTOMS MAY INCLUDE COUGHING, SORE THROAT, AND LABORED BREATHING. MAY BE ABSORBED THROUGH INHALATION OF DUST. SYMPTOMS MAY PARALLEL THOSE FROM INGESTION EXPOSURE.

SYMPTOMS OF SKIN CONTACT: MAY CAUSE IRRITATION, REDNESS, AND PAIN. SOLUTIONS ARE CORROSIVE.

SYMPTOMS OF EYE CONTACT: EYE IRRITANT! CONTACT MAY CAUSE CONJUNCTIVITIS, ULCERATION, CLOUDING OF THE CORNEA OR SEVERE EYE DAMAGE.

CHRONIC EXPOSURE: PROLONGED OR REPEATED SKIN EXPOSURE MAY CAUSE DERMATITIS. REPEATED INGESTION OF SMALL AMOUNTS MAY CAUSE MOTTLING OF TEETH AND BONE DAMAGE (OSTEOSCLEROSIS)

TOXICITY DATA:

| | |
|---------------------------|--------------------------|
| ORAL TOXICITY: | LD50; 180 MG/KG (RAT) |
| | LDLO; 71 MG/KG (HUMAN) |
| | LDLO; 75 MG/KG (DOG) |
| | LD50; 200 MG/KG (RABBIT) |
| INTRAPERITONEAL TOXICITY: | LDLO; 50 MG/KG (DOG) |
| SUBCUTANEOUS TOXICITY: | LDLO; 155 MG/KG (DOG) |

7 EMERGENCY AND FIRST AID PROCEDURES

EYE CONTACT: IMMEDIATELY, FLUSH WITH COPIOUS AMOUNTS OF WATER FOR AT LEAST 15 MINUTES WHILE HOLDING EYELIDS APART. WASHING WITHIN ONE MINUTE IS ESSENTIAL TO ACHIEVE MAXIMUM EFFECTIVENESS. CONTINUE WASHING EYES WITH WATER FOR AT LEAST 15 MINUTES LONGER. REFER TO OPHTHALMOLOGIST AFTER FIRST AID. GET MEDICAL ATTENTION

Mar 31 04 03:33p

670 WATER PLANT

910-451-3350

p.5

MATERIAL SAFETY DATA SHEET

AINANCE Monday, June 30, 2003
0550

PAGE 5

IMMEDIATELY.

SKIN CONTACT: WASH AFFECTED AREA THOROUGHLY WITH SOAP AND WATER. REMOVE CONTAMINATED CLOTHING AND LAUNDRER BEFORE REUSE. APPLY BANDAGE SOAKED IN MILK OF MAGNESIA. GET MEDICAL ATTENTION IMMEDIATELY.

INHALATION: REMOVE TO FRESH AIR. IF NOT BREATHING, GIVE ARTIFICIAL RESPIRATION. IF BREATHING IS DIFFICULT, GIVE OXYGEN. CONSULT A PHYSICIAN.

INGESTION: NEVER GIVE ANYTHING BY MOUTH TO AN UNCONSCIOUS PERSON. DO NOT INDUCE VOMITING. IMMEDIATELY GIVE TWO TABLESPOONS OF MAGNESIUM SULFATE AND A GLASS OF WATER. REPEAT THREE TIMES. FOLLOW WITH TWO TABLESPOONS OF MILK OF MAGNESIA AND A GLASS OF WATER. REPEAT THESE DOSAGES IN TEN MINUTES. GET MEDICAL ATTENTION IMMEDIATELY.

NOTES TO PHYSICIAN: FOR PAIN, USE 2 TO 3 DROPS OF 0.5% PENTOCAIN IN EACH EYE.

8 INDUSTRIAL HYGIENE AND OCCUPATIONAL CONTROL PROCEDURES

VENTILATION: A SYSTEM OF LOCAL EXHAUST IS RECOMMENDED TO KEEP EMPLOYEE EXPOSURE BELOW THE AIRBORNE EXPOSURE LIMITS. LOCAL EXHAUST IS USUALLY PREFERRED BECAUSE IT CONTROLS THE EMISSION AT ITS SOURCE, PREVENTING DISPERSION OF IT INTO THE GENERAL WORK AREA. REFER TO THE ACGIH DOCUMENT "INDUSTRIAL VENTILATION, A MANUAL OF RECOMMENDED PRACTICES" FOR DETAILS.

RESPIRATORY PROTECTION: NIOSH/MSHA APPROVED RESPIRATOR IF EXPOSURE MAY OR DOES EXCEED OCCUPATIONAL EXPOSURE LIMITS. GENERALLY A DUST/MIST RESPIRATOR MAY BE WORN IN AREAS WHERE THE TLV IS EXCEEDED UP TO TEN TIMES. ALTERNATIVELY, A SUPPLIED AIR FULL FACEPIECE RESPIRATOR OR AIRLINED HOOD MAY BE WORN.

EYE PROTECTION: CHEMICAL SPLASH GOGGLES AND/OR FACE SHIELD. CONTACT LENSES SHOULD NOT BE WORN WHEN WORKING WITH THIS MATERIAL.

AN EYE WASH FOUNTAIN AND QUICK-DRENCH FACILITIES SHOULD BE MAINTAINED IN THE WORK AREA.

SKIN PROTECTION: USE RUBBER OR PLASTIC IMPERVIOUS GLOVES AND BODY-COVERING CLOTHING.

PERSONAL HYGIENE: WASH THOROUGHLY AFTER HANDLING.

9 SAFE HANDLING, STORAGE AND USE PRECAUTIONS

PRECAUTIONARY MEASURES: AVOID CONTACT WITH SKIN, EYES, AND CLOTHING. WEAR PROTECTIVE CLOTHING, GLOVES, AND SPLASH GOGGLES OR SHIELD. WASH THOROUGHLY AFTER USING. AVOID BREATHING DUST OR MIST. USE WITH ADEQUATE VENTILATION.

Mar 31 04 03:34p

670 WATER PLANT

910-451-3350

p.6

MATERIAL SAFETY DATA SHEET

PAINANCE Monday, June 30, 2003
5 0330

PAGE 6

STORAGE AND HANDLING: KEEP IN A TIGHTLY CLOSED CONTAINER. STORE IN A COOL, DRY, WELL VENTILATED AREA. ISOLATE FROM INCOMPATIBLES.

PROTECT FROM PHYSICAL DAMAGE.

10 REGULATORY INFORMATION AND DISPOSAL PROCEDURES

SPILL/LEAK CLEAN-UP PROCEDURES: SWEEP, SCOOP, OR PICK UP SPILLED MATERIAL. AVOID DUSTING. PACKAGE FOR RECLAMATION OR RECOVERY IN DRY CONTAINERS. DO NOT FLUSH INTO SEWER OR STREAM.

DISPOSAL METHOD: DISPOSE IN ACCORDANCE WITH APPLICABLE FEDERAL, STATE, AND LOCAL ENVIRONMENTAL AND REGULATORY REQUIREMENTS.

TOXIC SUBSTANCES CONTROL ACT(TSCA): CHEMICAL INGREDIENTS ARE ON THE TSCA INVENTORY.

SUPERFUND REPORTABLE QUANTITY(RQ): 1000#/2270 KG.

HAZARDOUS WASTE NO.: NOT REGULATED.

SARA TITLE III: PLEASE CHECK WITH THE APPROPRIATE AGENCIES. (SECTION 313)

CANADIAN (WHMIS) LIST: THIS PRODUCT IS SUBJECT TO REPORTING.

NEW JERSEY LIST: EMPLOYERS WHO PRODUCE, USE, OR STORE THIS PRODUCT ARE REQUIRED TO FILE AN ANNUAL SURVEY DUE ON MARCH 1 OF EACH YEAR.

FOR STATES NOT LISTED: PLEASE CHECK WITH THE APPROPRIATE AGENCIES.

WARNING: THIS PRODUCT MAY CONTAIN A CHEMICAL KNOWN TO THE STATE OF CALIFORNIA TO CAUSE CANCER, OR BIRTH DEFECTS, AND/OR OTHER REPRODUCTIVE HARM.

11 TRANSPORTATION DATA

DOT SHIPPING NAME: SODIUM FLUORIDE
DOT HAZARD CLASS: 6.1
HAZARD IDENTIFICATION: SODIUM FLUORIDE
IDENTIFICATION NUMBER: UN 1690
PACKING GROUP: III *
LABEL: TOXIC OR POISON

*: FOR CONTAINERS/PACKAGES EXCEEDING 1,000 LBS, RQ IS REQUIRED.

NOTE: DURING AN INCIDENT INVOLVING THIS MATERIAL, USE OF DOT EMERGENCY RESPONSE GUIDE NO. 154 IS ALSO RECOMMENDED.

Mar 31 04 03:34p

670 WATER PLANT

910-451-3350

p. 7

MATERIAL SAFETY DATA SHEET
LAINANCE Monday, June 30, 2003

PAGE 7

ADDITIONAL WARNINGS AND INFORMATION

ALL INFORMATION PRESENTED HEREIN IS GIVEN IN GOOD FAITH AND IS BASED ON SOURCES AND TESTS CONSIDERED TO BE RELIABLE, BUT CANNOT BE GUARANTEED. IT IS THE USER'S FULL RESPONSIBILITY TO ACCEPT RISK FOR THE SAFETY, TOXICITY, HANDLING, STORAGE, AND USE OF THE PRODUCT, AS WELL AS TO DETERMINE THE SUITABILITY OF THE PRODUCT FOR A SPECIFIC PURPOSE. WE MAKE NO WARRANTY AS TO THE RESULTS TO BE OBTAINED IN USING THE PRODUCT; THEREFORE ALL RISKS MUST BE ASSUMED BY THE USER.

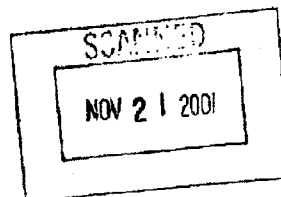

APPENDIX E

Chemical Mass Balance Computations for Fluoride Solution Using the LMI Fluoride Saturator Kit Number 28850

Notation

MW = molecular weight

$[NaF]_i$, $[F]_i$ = injection concentration at the pump

$\Delta F_d = F$ concentration increase in delivered water during test

$[F]_d = F$ concentration in delivered water

V_F = Volume of fluoride solution

Q = water demand

q = injection pump flow rate

S = dilution

General data

$MW NaF = 42$ g/mol

$MW F = 19$ g/mol

NaF solubility = 42 g/L (equivalent to 19 g/L of F)

 F standard

Maximum $[F]_d$ concentration during test (estimated) = 2.0 mg/L

Background F concentration (estimated) = 0.2 mg/L (based on 7 day shut off of HP Fluoride treatment)

Maximum allowable F increase during test $\Delta F_d = 1.8$ mg/L

Tracer test

Demand (estimated) $Q = 3$ MGD = 125,000 gph

$[F]_i = 4\%$ solution = 40,000 mg/L

Required dilution (S) = 40,000 mg/L / 1.8 mg/L = 22,222:1

Volume of F required

$V_F = Q/S = 125,000$ gph/22,222 = 5.625 gph

4 hour tracer test = 4 x 5.625 = 22.5 gallons of solution

6 hour tracer test = 6 x 5.625 = 33.75 gallons

APPENDIX F

Descriptions of Test Hydrant and Sampling Locations

Table F-1. Description of sampling locations, logger identifications, and other pertinent information that will be used to monitor water-distribution system during preliminary test at Marine Corps Base, Camp Lejeune, North Carolina (refer to Plate 1 for map showing sampling locations).

| Hadnot Point: Hydrant Sampling Locations | | | | | | | | | |
|--|---------|---------------------|------------------------------|-----------------|-------------------------|--|---|--|------------|
| ¹ Supply Area ID | Test ID | ² Map ID | ³ ATSDR Logger ID | ATSDR Object ID | Camp Lejeune Hydrant ID | Longitude State Plane NAD83 (feet) (approx.) | Latitude State Plane NAD83 (feet) (approx.) | Sample Hydrant Location | Pipe Diam. |
| HP | T0 | F6 | F01 | 306 | H-9-10 | 2490200.37 | 341642.14 | S. side of Julian C. Smith Rd. (northern loop) ≈ 700 ft. W. of Cutler St. | 10 in. |
| | | | P01 | 305 | 3H-8-10 | 2490600.17 | 341674.54 | S. side of Julian C. Smith Rd. (southern loop) ≈ 300 ft. W. of Cutler St. | 10 in. |
| | | | C01 | 315 | 3-149-8 | 2489539.97 | 340649.01 | N. side of Julian C. Smith Rd. ≈ 650 ft. W. of Olive St. (in front of Bldg. H1) | 10 in. |
| HP | T0 | F7 | F02 | 640 | 3-26-8 | 2494975.34 | 339146.24 | S. side of C Street ≈ 950 ft. W. of McHugh Blvd. | 8 in. |
| | | | P02 | 641 | none | 2494587.18 | 339012.54 | S. side of C Street ≈ 1350 ft. W. of McHugh Blvd. (across street from Bldg. 147) | 8 in. |
| | | | C02 | 656 | none | 2495447.04 | 340361.62 | W. side of McHugh Blvd. ≈ 200 ft. S. of A Street (across street from St. Francis Church) | 12 in. |
| HP | T0 | F7 | F03 | 1113 | 3-50-12 | 2496386.42 | 337528.51 | S. W. corner of McHugh Blvd. and G Street intersection (in front of Hadnot Point WTP) | 12 in. |
| | | | P03 | 1093 | none | 2496120.90 | 337467.83 | N. side of G Street ≈ 300 ft. W. of McHugh Blvd. (across street from Hadnot Point WTP) | 12 in. |
| | | | C03 | 545 | 3-141-8 | 2496964.85 | 337937.35 | W. side of Post Ln. ≈ 500 ft. N. of Holcomb Blvd. (in front of Bldg. 27) | 8 in. |

¹ Supply Area ID: HP = Hadnot Point

² Map ID: Camp Lejeune AutoCAD referencing system

³ ATSDR Logger ID: F = Fluoride; P = Pressure; C = Conductivity

Table F-1. Description of sampling locations, logger identifications, and other pertinent information that will be used to monitor water-distribution system during preliminary test at Marine Corps Base, Camp Lejeune, North Carolina (refer to Plate 1 for map showing sampling locations).

| Hadnot Point: Hydrant Sampling Locations | | | | | | | | | |
|--|---------|---------------------|------------------------------|-----------------|-------------------------|--|---|--|------------|
| ² Supply Area ID | Test ID | ² Map ID | ³ ATSDR Logger ID | ATSDR Object ID | Camp Lejeune Hydrant ID | Longitude State Plane NAD83 (feet) (approx.) | Latitude State Plane NAD83 (feet) (approx.) | Sample Hydrant Location | Pipe Diam. |
| HP | T0 | G7 | F04 | 1065 | 3-72-8 | 2495721.79 | 335539.74 | N. side of H Street ≈ 750 ft. E. of Julian C. Smith Rd. (in front of Bldg. 325) | 8 in. |
| | | | P04 | 1066 | 3-73-8 | 2496025.88 | 335759.52 | N. side of H Street ≈ 1100 ft. E. of Julian C. Smith Rd. (in front of Bldg. 319) | 8 in. |
| | | | C04 | 1085 | 3-56-12 | 2494421.09 | 336126.21 | S.E. corner of G Street and Julian C. Smith Rd. intersection | 12 in. |
| HP | T0 | G8 | F05 | 608 | none | 2498133.32 | 334117.91 | S. side of N Street, ≈ 350 ft. E. of M St. intersection, (in front of Bldg. HP-507) | 8 in. |
| | | | P05 | 609 | none | 2497890.30 | 333776.65 | S. side of N Street ≈ 100 ft. W. of M St. intersection (in front of Bldg. HP-509) | 8 in. |
| | | | C05 | 1183 | 5-26-12 | 2501009.53 | 333623.14 | N. side of McHugh Blvd. ≈ 500 ft. W. of Gonzalez Blvd. (in front of well house SFC-116) | 12 in. |
| HP | T0 | H8 | F06 | 1147 | 5-197-12 | 2501177.60 | 331666.82 | E. side of Gonzalez Blvd. at tank SFC314 (in front of Bldg. FC-330) | 8 in. |
| | | | P06 | 1148 | 5-198-12 | 2501487.48 | 331718.60 | ≈ 200 ft. in front of Gymnasium (behind Bldg. FC-330) | 8 in. |
| | | | C06 | 1132 | 5-179-8 | 2500089.95 | 330120.70 | S. side of H.M. Smith Blvd. (Reasoner St.) ≈ 750 ft. E. of Gonzalez Blvd. (in front of Bldg. FC-500) [² rd FSG Cons. Admin. Center] | 8 in. |

² Supply Area ID: HP = Hadnot Point

² Map ID: Camp Lejeune AutoCAD referencing system

³ ATSDR Logger ID: F = Fluoride; P = Pressure; C = Conductivity

Table F-1. Description of sampling locations, logger identifications, and other pertinent information that will be used to monitor water-distribution system during preliminary test at Marine Corps Base, Camp Lejeune, North Carolina (refer to Plate 1 for map showing sampling locations).

| Hadnot Point: Hydrant Sampling Locations | | | | | | | | | |
|--|---------|---------------------|------------------------------|-----------------|-------------------------|--|---|---|------------|
| ³ Supply Area ID | Test ID | ² Map ID | ³ ATSDR Logger ID | ATSDR Object ID | Camp Lejeune Hydrant ID | Longitude State Plane NAD83 (feet) (approx.) | Latitude State Plane NAD83 (feet) (approx.) | Sample Hydrant Location | Pipe Diam. |
| HP | T0 | F8 | F07 | 520 | 5-80-8 | 2500201.34 | 337626.87 | N. corner of Fir St. and Michael Rd. intersection (hydrant base ≈ 12 in. above ground surface) | 8 in. |
| | | | P07 | 521 | 5-87-8 | 2499855.45 | 337320.88 | N. corner of Gum St. and Michael Rd. intersection | 8 in. |
| | | | C07 | 999 | 5-241-12 | 2505629.76 | 332767.23 | N. side of McHugh Blvd. ≈ 400 ft. W. of Gonzalez Blvd. (in front of Bldg. FC-270) | 12 in. |
| HP | T0 | F8 | F08 | 507 | 5-69-8 | 2500337.51 | 338780.43 | S.E. corner of Dogwood St. and Gibb Rd. intersection (across street from Bldg. 1403) | 8 in. |
| | | | P08 | 504 | 5-72-8 | 2499819.39 | 339364.54 | E. side of Dogwood St. ≈ 100 ft. N. of West Rd. | 8 in. |
| | | | C08 | 2257 | none | 2501132.53 | 340865.58 | S. side of Holcomb Blvd. ≈ 1000 ft. E. of Birch St. | 12 in. |
| HP | T0 | F9 | F09 | 968 | 5-265-12 | 2503964.33 | 338742.44 | ≈ 350 ft. W. of Sneeds Ferry Rd. and Lyman St. intersection (N. side of street) | 12 in. |
| | | | P09 | 921 | 5-111-6 | 2503374.73 | 338823.09 | ≈ 500 ft S. of Louis Rd. between Franklin St. and O Street (on E. side of Bldg. 915) | 6 in. |
| | | | C09 | 2255 | 5-30-12 | 2502017.02 | 343158.97 | E. side of Holcomb Blvd. at intersection with Sneeds Ferry Rd. | 12 in. |

³ Supply Area ID: HP = Hadnot Point

² Map ID: Camp Lejeune AutoCAD referencing system

³ ATSDR Logger ID: F = Fluoride; P = Pressure; C = Conductivity

APPENDIX G

Data-Entry Log Sheets

P01 **ATSDR FIELD WORK** **P01**
Camp Lejeune, NC – Water Distribution System
Hadnot Point Test 0, May 2004

ATSDR Logger ID/Hydrant Name: P01
ATSDR Object ID: 305
Camp Lejeune Hydrant ID: 3H-8-10
Longitude (NAD83 feet): 2490600.17
Latitude (NAD83 feet): 341674.54
Location: S. side of Julian C. Smith Rd. (southern loop)
≈ 300 ft. W. of Cutler St.



Hand Gauge Pressure
 Date: ___/___/___ Time: ___:___ Initial (psi): ___
 Date: ___/___/___ Time: ___:___ Final (psi): ___

| DICKSON PR300 Pressure Logger | | | |
|--------------------------------------|------|----------------|-------|
| Date | Time | Pressure (psi) | Notes |
| 5/___/04 | : | | |
| 5/___/04 | : | | |
| 5/___/04 | : | | |
| 5/___/04 | : | | |
| 5/___/04 | : | | |
| 5/___/04 | : | | |
| 5/___/04 | : | | |
| 5/___/04 | : | | |
| 5/___/04 | : | | |
| 5/___/04 | : | | |
| 5/___/04 | : | | |
| 5/___/04 | : | | |
| 5/___/04 | : | | |
| 5/___/04 | : | | |
| 5/___/04 | : | | |
| 5/___/04 | : | | |
| 5/___/04 | : | | |
| 5/___/04 | : | | |
| 5/___/04 | : | | |
| 5/___/04 | : | | |
| 5/___/04 | : | | |

F01**ATSDR FIELD WORK****Camp Lejeune, NC – Water Distribution System
Hadnot Point Test 0, May 2004****F01**

ATSDR Logger ID/Hydrant Name: F01
ATSDR Object ID: 306
Camp Lejeune Hydrant ID: H-9-10
Longitude (NAD83 feet): 2490200.37
Latitude (NAD83 feet): 341642.14
Location: S. side of Julian C. Smith Rd. (northern loop)
≈ 700 ft. W. of Cutler St.



Logger Installation Date: ____/____/____
Time: ____:____

| HORIBA W-23XD Monitoring System | | | | | | | | pHTestr 30 | | Notes |
|---------------------------------|----------|------|----|---------------|--------|------------------------------|-----------------------------|------------|----|-------|
| Sample ID | Date | Time | pH | Cond. (μS/cm) | T (°C) | Cl ⁻ (mg/L) ION 1 | F ⁻ (mg/L) ION 2 | T (°C) | pH | |
| | 5/___/04 | : | | | | | | | | |
| | 5/___/04 | : | | | | | | | | |
| | 5/___/04 | : | | | | | | | | |
| | 5/___/04 | : | | | | | | | | |
| | 5/___/04 | : | | | | | | | | |
| | 5/___/04 | : | | | | | | | | |
| | 5/___/04 | : | | | | | | | | |
| | 5/___/04 | : | | | | | | | | |
| | 5/___/04 | : | | | | | | | | |
| | 5/___/04 | : | | | | | | | | |
| | 5/___/04 | : | | | | | | | | |
| | 5/___/04 | : | | | | | | | | |
| | 5/___/04 | : | | | | | | | | |
| | 5/___/04 | : | | | | | | | | |
| | 5/___/04 | : | | | | | | | | |
| | 5/___/04 | : | | | | | | | | |
| | 5/___/04 | : | | | | | | | | |
| | 5/___/04 | : | | | | | | | | |
| | 5/___/04 | : | | | | | | | | |
| | 5/___/04 | : | | | | | | | | |
| | 5/___/04 | : | | | | | | | | |
| | 5/___/04 | : | | | | | | | | |
| | 5/___/04 | : | | | | | | | | |
| | 5/___/04 | : | | | | | | | | |
| | 5/___/04 | : | | | | | | | | |

C01 **ATSDR FIELD WORK** C01

Camp Lejeune, NC – Water Distribution System Hadnot Point Test 0, May 2004

ATSDR Logger ID/Hydrant Name: C01

ATSDR Object ID: 315

Camp Lejeune Hydrant ID: 3-149-8

Longitude (NAD83 feet): 2489539.97

Latitude (NAD83 feet): 340649.01

Location: N. side of Julian C. Smith Rd.

≈ 650 ft. W. of Olive St.

(in front of Bldg. H1)



Logger Installation Date: ___/___/___
Time: ___:___

| HORIBA W-21SDI Monitoring System | | | | D-54 | pHTestr 30 | | Notes | |
|----------------------------------|----------|------|---------------|--------|---------------|--------|-------|----|
| Sample ID | Date | Time | Cond. (µS/cm) | T (°C) | Cond. (µS/cm) | T (°C) | | pH |
| | 5/___/04 | : | | | | | | |
| | 5/___/04 | : | | | | | | |
| | 5/___/04 | : | | | | | | |
| | 5/___/04 | : | | | | | | |
| | 5/___/04 | : | | | | | | |
| | 5/___/04 | : | | | | | | |
| | 5/___/04 | : | | | | | | |
| | 5/___/04 | : | | | | | | |
| | 5/___/04 | : | | | | | | |
| | 5/___/04 | : | | | | | | |
| | 5/___/04 | : | | | | | | |
| | 5/___/04 | : | | | | | | |
| | 5/___/04 | : | | | | | | |
| | 5/___/04 | : | | | | | | |
| | 5/___/04 | : | | | | | | |
| | 5/___/04 | : | | | | | | |
| | 5/___/04 | : | | | | | | |
| | 5/___/04 | : | | | | | | |
| | 5/___/04 | : | | | | | | |
| | 5/___/04 | : | | | | | | |
| | 5/___/04 | : | | | | | | |
| | 5/___/04 | : | | | | | | |
| | 5/___/04 | : | | | | | | |
| | 5/___/04 | : | | | | | | |
| | 5/___/04 | : | | | | | | |
| | 5/___/04 | : | | | | | | |
| | 5/___/04 | : | | | | | | |
| | 5/___/04 | : | | | | | | |

Hadnot Point Test 0: F01

| Lab Analysis | | | | | | | | | | Field Measurement | | | | | | |
|--------------|----------|------|--------|------------------------|-----------------------|------|--------|--------------------------------|--|-------------------|--------|---------------|----|--------|------------------------------|-----------------------------|
| Sample ID | Date | Time | T (°C) | D-53 | | Time | T (°C) | D-53 | | Time | T (°C) | Cond. (µS/cm) | pH | T (°C) | Cl ⁻ (mg/L) ION 1 | F ⁻ (mg/L) ION 2 |
| | | | | Cl ⁻ (mg/L) | F ⁻ (mg/L) | | | F ⁻ (mg/L) TISAB II | | | | | | | | |
| | 5/___/04 | : | | | | : | | | | : | | | | | | |
| | 5/___/04 | : | | | | : | | | | : | | | | | | |
| | 5/___/04 | : | | | | : | | | | : | | | | | | |
| | 5/___/04 | : | | | | : | | | | : | | | | | | |
| | 5/___/04 | : | | | | : | | | | : | | | | | | |
| | 5/___/04 | : | | | | : | | | | : | | | | | | |
| | 5/___/04 | : | | | | : | | | | : | | | | | | |
| | 5/___/04 | : | | | | : | | | | : | | | | | | |
| | 5/___/04 | : | | | | : | | | | : | | | | | | |
| | 5/___/04 | : | | | | : | | | | : | | | | | | |
| | 5/___/04 | : | | | | : | | | | : | | | | | | |
| | 5/___/04 | : | | | | : | | | | : | | | | | | |
| | 5/___/04 | : | | | | : | | | | : | | | | | | |
| | 5/___/04 | : | | | | : | | | | : | | | | | | |
| | 5/___/04 | : | | | | : | | | | : | | | | | | |
| | 5/___/04 | : | | | | : | | | | : | | | | | | |
| | 5/___/04 | : | | | | : | | | | : | | | | | | |
| | 5/___/04 | : | | | | : | | | | : | | | | | | |

Hadnot Point Test 0: C01

| Lab Analysis | | | | | | | | | | Field Measurement | | | | | | | |
|--------------|----------|------|--------|------------------------|-----------------------|------|--------|-----------------------|---------------|-------------------|------|---------------|--------|---------|--|---------------|------|
| Sample ID | Date | Time | T (°C) | D-53 | | Time | T (°C) | F ⁻ (mg/L) | D-53 | | Time | Cond. (µS/cm) | T (°C) | W-21SDI | | Cond. (µS/cm) | D-54 |
| | | | | Cl ⁻ (mg/L) | F ⁻ (mg/L) | | | | Cond. (µS/cm) | T (°C) | | | | | | | |
| | 5/___/04 | : | | | | : | | | | | : | | | | | | |
| | 5/___/04 | : | | | | : | | | | | : | | | | | | |
| | 5/___/04 | : | | | | : | | | | | : | | | | | | |
| | 5/___/04 | : | | | | : | | | | | : | | | | | | |
| | 5/___/04 | : | | | | : | | | | | : | | | | | | |
| | 5/___/04 | : | | | | : | | | | | : | | | | | | |
| | 5/___/04 | : | | | | : | | | | | : | | | | | | |
| | 5/___/04 | : | | | | : | | | | | : | | | | | | |
| | 5/___/04 | : | | | | : | | | | | : | | | | | | |
| | 5/___/04 | : | | | | : | | | | | : | | | | | | |
| | 5/___/04 | : | | | | : | | | | | : | | | | | | |
| | 5/___/04 | : | | | | : | | | | | : | | | | | | |
| | 5/___/04 | : | | | | : | | | | | : | | | | | | |
| | 5/___/04 | : | | | | : | | | | | : | | | | | | |
| | 5/___/04 | : | | | | : | | | | | : | | | | | | |
| | 5/___/04 | : | | | | : | | | | | : | | | | | | |
| | 5/___/04 | : | | | | : | | | | | : | | | | | | |

APPENDIX H

Training Agenda for HORIBA Data Loggers

HORIBA W-23XD MONITORING SYSTEM TRAINING
MEETING WITH PAM MILLETT (HORIBA) AND MARIO OVES (INSTRU-MED)
 April 21, 2004

Agenda and Schedule

| <u>Time</u> | <u>Activity</u> |
|-------------|--|
| 0830 hrs | Pam and Mario arrive at Century Center and check in through security 1. Photo ID required |
| 0900 hrs | Discussions in Conference Room 1B 1. Overview of equipment setup (batteries, connect control unit, power, menu navigation, time setup) 2. Handling, maintaining, and storing probes and sensors |
| 0930 hrs | Calibration of the W-23XD Monitoring System 1. Hands-on training using standards to calibrate |
| 1100 hrs | Fire Hydrant Setup 1. Install equipment on fire hydrant outside Century Center 2. Allow W-23XD to monitor water quality 3. Test control unit display menu while W-23XD continuously recording |
| 1200 hrs | Lunch |
| 1300 hrs | Disconnect Equipment from Fire Hydrant 1. Clean and store W-23XD probe and sensors |
| 1400 hrs | Data Recovery in Room 3B 1. Download data to laptop using extension unit connection 2. Analyze data |
| 1500 hrs | Wrap up and Summary |

Attendees

Pam Millett, Horiba
 Mario Oves, Instru-Med
 Bob Faye, Contractor
 Amy Funk, EHH/NCEH
 Morris Maslia, DHAC/ATSDR
 Jason Sautner, DHAC/ATSDR
 Claudia Valanezuela, ORISE, Ga. Tech

APPENDIX I

Signage for Sampling Hydrant Locations

U.S. GOVERNMENT TEST HYDRANT AND EQUIPMENT**Please Do Not Disturb
Fire Emergency Use Only**

This hydrant and test equipment are being used to conduct a series of tests of the water-distribution system. Should you have any questions pertaining to these tests, please contact:

Scott A. Brewer
Environmental Management Division
MCB, Camp Lejeune, NC
Telephone: (910) 451-5003



PLATE

Plate 1 was originally issued as a draft fold-out map.



Appendix S8.2. Estimated Water Consumption and Building Categories for the Holcomb Boulevard Water Treatment Plant Service Area

Table S8.2.1. Holcomb Boulevard water treatment plant service area water consumption estimation, Hadnot Point–Holcomb Boulevard study area, U.S. Marine Corps Base Camp Lejeune, North Carolina, 2004.

[GPD, gallons per day; GPY, gallons per year; gal, gallon; min, minute; Data from ECG, Inc. 1999]

| Family Housing | | Paradise Point | | | |
|-----------------------|--------------------|-----------------------|---------------------|--|-------------------|
| Total population: | 1,771 | | (2004) | | |
| Occupied units: | 472 | | (2004) | | |
| Plumbing fixtures | Consumption factor | | Assumptions | | Consumption (GPD) |
| Toilets | 4.5 gal/flush | | 4 flush/day/person | | 31,878 |
| Faucets | 3.3 gal/min | | 4 min/day/person | | 23,377 |
| Shower heads | 2.5 gal/min | | 4.8 min/person | | 21,252 |
| Baths | — | | 40% of shower | | 8,501 |
| Dishwashers | 9 gal/load | | 1 load/day | | 4,248 |
| Laundry | — | | 16.5 gal/person/day | | 29,222 |
| | | | Total (GPD) | | 118,478 |
| | | | Total (GPD/person) | | 67 |

Note: consumption factors given by maintenance supervisor/manager

| Family Housing | | Berkeley Manor | | | |
|-----------------------|--------------------|-----------------------|---------------------|--|-------------------|
| Total population: | 2,660 | | (2004) | | |
| Occupied units: | 660 | | (2004) | | |
| Plumbing fixtures | Consumption factor | | Assumptions | | Consumption (GPD) |
| Toilets | 1.6 gal/flush | | 4 flush/day/person | | 17,024 |
| Faucets | 2.5 gal/min | | 4 min/day/person | | 26,600 |
| Shower heads | 2 gal/min | | 4.8 min/person | | 25,536 |
| Baths | — | | 40% of shower | | 10,214 |
| Dishwashers | 9 gal/load | | 1 load/day | | 5,940 |
| Laundry | — | | 16.5 gal/person/day | | 43,890 |
| | | | Total (GPD) | | 129,204 |
| | | | Total (GPD/person) | | 49 |

Note: consumption factors given by maintenance supervisor/manager

| Family Housing | | Watkins Village | | | |
|-----------------------|--------------------|------------------------|---------------------|--|-------------------|
| Total population: | 1,186 | | (2004) | | |
| Occupied units: | 216 | | (2004) | | |
| Plumbing fixtures | Consumption factor | | Assumptions | | Consumption (GPD) |
| Toilets | 4.5 gal/flush | | 4 flush/day/person | | 21,348 |
| Faucets | 3.3 gal/min | | 4 min/day/person | | 15,655 |
| Shower heads | 2.5 gal/min | | 4.8 min/person | | 14,232 |
| Baths | — | | 40% of shower | | 5,693 |
| Dishwashers | 9 gal/load | | 1 load/day | | 1,944 |
| Laundry | — | | 16.5 gal/person/day | | 19,569 |
| | | | Total (GPD) | | 78,441 |
| | | | Total (GPD/person) | | 66 |

Note: consumption factors given by maintenance supervisor/manager

Table S8.2.1. Holcomb Boulevard water treatment plant service area water consumption estimation, Hadnot Point–Holcomb Boulevard study area, U.S. Marine Corps Base Camp Lejeune, North Carolina, 2004.—Continued

[GPD, gallons per day; GPY, gallons per year; gal, gallon; min, minute; Data from ECG, Inc. 1999]

| Family Housing | | Tarawa Terrace | | |
|-----------------------|--------------------|-----------------------|---------------------|-------------------|
| Total population: | 4,521 | | (2004) | |
| Occupied units: | 1,375 | | (2004) | |
| Plumbing fixtures | Consumption factor | | Assumptions | Consumption (GPD) |
| Toilets | 4.1 | gal/flush | 4 flush/day/person | 74,144 |
| Faucets | 2.8 | gal/min | 4 min/day/person | 50,635 |
| Shower heads | 2.5 | gal/min | 4.8 min/person | 54,252 |
| Baths | — | | 40% of shower | 21,701 |
| Dishwashers | 10 | gal/load | 1 load/day | 13,750 |
| Laundry | — | | 16.5 gal/person/day | 74,597 |
| Total (GPD) | | | | 289,079 |
| Total (GPD/person) | | | | 64 |

Note: consumption factors given by maintenance supervisor/manager

| Family Housing | | Midway Park | | |
|-----------------------|--------------------|--------------------|---------------------|-------------------|
| Total population: | 1,256 | | (2004) | |
| Occupied units: | 518 | | (2004) | |
| Plumbing fixtures | Consumption factor | | Assumptions | Consumption (GPD) |
| Toilets | 2.96 | gal/flush | 4 flush/day/person | 14,871 |
| Faucets | 2.8 | gal/min | 4 min/day/person | 14,067 |
| Shower heads | 2.4 | gal/min | 4.8 min/person | 14,469 |
| Baths | — | | 40% of shower | 5,788 |
| Dishwashers | 10 | gal/load | 1 load/day | 5,180 |
| Laundry | — | | 16.5 gal/person/day | 20,724 |
| Total (GPD) | | | | 75,099 |
| Total (GPD/person) | | | | 60 |

Note: consumption factors given by maintenance supervisor/manager

| Family Housing | | Camp Knox Trailer Park | | |
|-----------------------|--------------------|-------------------------------|-----------------------------|-------------------|
| Total population: | 97 | | (2004) | |
| Occupied units: | 28 | | (mobile home spaces) (2004) | |
| Plumbing fixtures | Consumption factor | | Assumptions | Consumption (GPD) |
| Toilets | 4 | gal/flush | 4 flush/day/person | 1,552 |
| Faucets | 3 | gal/min | 4 min/day/person | 1,164 |
| Shower heads | 3 | gal/min | 4.8 min/person | 1,397 |
| Dishwashers | 10 | gal/load | 1 load/day | 280 |
| Laundry | — | | 16.5 gal/person/day | 1,601 |
| Total (GPD) | | | | 5,993 |
| Total (GPD/person) | | | | 62 |

Note: consumption factors are average fixture flow rates

Table S8.2.1. Holcomb Boulevard water treatment plant service area water consumption estimation, Hadnot Point–Holcomb Boulevard study area, U.S. Marine Corps Base Camp Lejeune, North Carolina, 2004.—Continued

[GPD, gallons per day; GPY, gallons per year; gal, gallon; min, minute; Data from ECG, Inc. 1999]

| Bachelor Housing | | | | |
|-------------------------|--------------------|-------------|---------------------|-------------------|
| Total population: | 1,871 | | (2004) | |
| Plumbing fixtures | Consumption factor | | Assumptions | Consumption (GPD) |
| Toilets | 4.5 | (gal/flush) | 3 flush/day/person | 25,259 |
| Faucets | 3.5 | (gal/min) | 4 min/day/person | 26,194 |
| Shower heads | 4.5 | (gal/min) | 4.8 min/person | 40,414 |
| Laundry | — | | 16.5 gal/day/person | 30,872 |
| | | | Total (GPD) | 122,738 |
| | | | Total (GPD/person) | 66 |

Note: consumption factors given by maintenance supervisor/manager

| Offices and Work Areas | | | | |
|-------------------------------|--------------------|-------------|--------------------------------|------------------------------|
| Total population: | 3,504 | | (1998) | |
| Plumbing fixtures | Consumption factor | | Assumptions | Consumption (week day) (GPD) |
| Toilets | 4 | (gal/flush) | 1 flush/day/person | 14,016 |
| Faucets | 3 | (gal/min) | 1 min/day/person | 10,512 |
| Urinals | 2 | (gal/flush) | 2 flush/day/person, 80% men | 11,213 |
| | | | Total (GPD) | 35,741 |
| | | | Total (GPD/person) | 10 |

| Mess Hall | | | | |
|-------------------|--------------------|----------|-----------------------|-------------------|
| Total population: | 1,648 | | Camp Johnson (2004) | |
| Population | Consumption factor | | Assumptions | Consumption (GPD) |
| Permanent | 3.2 | gal/meal | 2.75 meals/day/person | 14,502 |
| | | | Total (GPD) | 14,502 |
| | | | Total (GPD/person) | 9 |

| Irrigation | | | |
|-------------------|--------------------|-------------|-----------------------------------|
| Occupied units: | 3,241 | | (2004) |
| | Consumption factor | | Consumption (153 days/year) (GPD) |
| 18,453 | gal/year/house | | 390,890 |
| | | Total (GPD) | 390,890 |

Table S8.2.1. Holcomb Boulevard water treatment plant service area water consumption estimation, Hadnot Point–Holcomb Boulevard study area, U.S. Marine Corps Base Camp Lejeune, North Carolina, 2004.—Continued

[GPD, gallons per day; GPY, gallons per year; gal, gallon; min, minute; Data from ECG, Inc. 1999]

| Cooling System | | | |
|-----------------------|-------------------------------|--------------------------------|--------------------------|
| Building | Consumption 1998 (GPY) | Days operation per year | Consumption (GPD) |
| 84, 2615 | 2,555,000 | 184 | 13,886 |
| Total (GPD) | | | 13,886 |

| Heating Plants | | | |
|---------------------------|---------------------------------------|---|----------------------------|
| Building | Steam production 1998 (lb/day) | Make-up water use as percent of steam production (%) | Make-up water (GPD) |
| Tarawa Terrace, M625 | 203,200 | 37 | ¹ 9,000 |
| Tarawa Terrace, M230 | 16,000 | 60 (<i>assumed</i>) | 1,000 |
| Holcomb Boulevard, PP2615 | 58,000 | 60 (<i>assumed</i>) | 4,000 |
| Total (GPD) | | | 14,000 |

¹ Average make-up water used during 1998. Only M625 has a make-up water meter.

| Major Tenants | | | |
|--|-------------------------------|--------------------------------|--------------------------|
| Building | Consumption 1998 (GPY) | Days operation per year | Consumption (GPD) |
| Dependent school, 1943 | 453,000 | 275 | 1,647 |
| Dependent school, 5400 | 689,000 | 275 | 2,505 |
| Dependent school, 825 | 3,481,000 | 275 | 12,658 |
| Dependent school, 835 | 3,748,000 | 275 | 13,629 |
| MCX, 820 Berkeley Manor | 231,000 | 365 | 633 |
| MWR (Offic. club and heating plants), 2615 | 3,663,000 | 365 | 10,036 |
| Naval investigative services, H32 | 982,000 | 365 | 2,690 |
| MWR Exchange, TT2478 | 65,000 | 365 | 178 |
| MWR Exchange at Knox Trailer Park | 60,000 | 365 | 164 |
| Dependent schools, TT48 | 1,005,000 | 275 | 3,655 |
| Dependent school, TT60 | 851,000 | 275 | 3,095 |
| Dependent schools, 40 | 372,000 | 275 | 1,353 |
| Naval hospital BEQ | Bachelor Housing | 365 | — |
| Naval hospital BEQ | Bachelor Housing | 365 | — |
| Naval hospital pest control, NH114 | 73,000 | 365 | 200 |
| Naval hospital maintenance shop, NH118 | 364,000 | 365 | 997 |
| Naval hospital | 24,769,000 | 365 | 67,860 |
| Total (GPD) | | | 121,301 |

Table S8.2.2. Building categories, Hadnot Point–Holcomb Boulevard study area, U.S. Marine Corps Base Camp Lejeune, North Carolina, 2004 (from ECG, Inc. 1999).

| Category | Number of demand nodes | Building name/Narrative in building shapefile | Category | Number of demand nodes | Building name/Narrative in building shapefile |
|------------------|------------------------|--|---------------|------------------------|---|
| Armory | 15 | ARMORY | Hostess House | 1 | HOSTESS HOUSE/ADMIN |
| Auto Repair | 25 | AUTO-VEH MAINT SHOP AUTO HOBBY SHOP AUTO MAINT SHOP MCX AUTO REPAIR STA MCX TIRE SERVICE STA AUTO ORGTL SHOP | Kennel | 3 | KENNEL |
| Bachelor Housing | 111 | BEQ BOQ | Memorial | 1 | FIELD HSE GOETTGE MEMORIAL |
| Brig | 1 | BRIG | Mess Hall | 11 | MESS OPEN ENLISTED DINING FACILITY |
| Burger King | 1 | BASE LIBRARY/BURGER KING | Other | 45 | 4 PLAY FLDS DUGOUTS VIC 835 BAND PRACTICE BLDG BASE ENTRANCE SIGN BILLBOARD BOOSTER PUMPING STATION BOY SCOUT CANOPY DRIVING RNG/VIC1903 COVERED PATIO DET POOL FACILITY DISPATCH SHACK ENTR SIGN WATKINS VILLAGE EXC SNACK STND VIC GOLF COUR FIBER OPTIC BLD VIC GEN QTRS GATE HOUSE / PINEY GREEN GATE/SENT HOUSE GENERATOR GENERATOR SHELTER GENERATOR/PUMP GOLF PAVILION GOLF SHELTER GRD WATER REMED VIC 976-SHAW HITCHING RAIL SHELTER IND WST TRT BLD LATRINE/SHOWER MARSTON - METAL METAL LOAD/UNLOAD MFCU ATM NONPOTABLE OFFICERS CLUB BILLBOARD OTHER PAVED AREA P/O 1290 PAVMT/GRNDS EQUIP SHED PEAK SHAVE GENERATOR PICNIC SHELTER PLAYGROUNDS PONY SHELTER PUBLIC TOILET PUMP HOUSE REC GRDS 631 FALLZONE REC PAVILLION/GOLF SHELTER RODEO RING GRANDSTAND SAWDUST BARN-RIDING STABLE SCOUT CENTER SCOUT PAVILLION SEWAGE LIFT STATION/CANOPY SEWAGE PUMP SHD SEWAGE PUMPING STATION SHELTER SIGNS SKINNING SHELTER STABLE STARTER HOUSE |
| Bus Station | 1 | BUS STATION | | | |
| Chapel | 7 | CHAPEL RELIGIOUS MINISTRY FACILITY PROTESTANT CHAPEL CATHOLIC CHAPEL | | | |
| Child Care | 7 | CHILD CARE CENTER CHILD DEVELOPMENT CENTER CHILD DEVELOPMENT/YOUTH CNTR RUSSELL ELEM SCHOOL | | | |
| Clinic | 9 | VETERINARY SERVICE BEQ/MEDICAL CLINIC PHYSICAL EXAMS CLINIC OUT PAT MEDICAL/DENTAL CLINIC | | | |
| Cooling System | 17 | building numbers from WCA | | | |
| Club | 1 | GOLF CLUB HOUSE | | | |
| Exchange | 19 | COMMISSARY EXCH INSTL WHSE EXCHANGE EXCHANGE SERVICE OUTLET EXCHANGE SNACK STAND LOCATION EXCHANGE MAIN MARCOR EXCHANGE TELEPHONE EXCHANGE BUILDING XCHANGE RETAIL STORE | | | |
| Family Housing | 3545 | PUBLIC QUARTERS MARRIED OFFICERS QUARTERS MOQ PUB QTRS/FLG OFF P/Q/CDR/LCDR PUBLIC QUARTERS ENLISTED | | | |
| Fire Station | 7 | FIRE STATION POLICE/FIRE STATION | | | |
| Gas Station | 7 | FILLING STATION LOC EX/FILLING STA EXCHANGE/GAS STATION SELF-SERVICE 7-DAY STORE/GAS STATION FUEL ISLAND/ASTS GAS STATION | | | |
| Naval Hospital | 5 | building given in WCA | | | |
| Officers Club | 1 | building given in WCA | | | |
| Heating Plant | 6 | HEATING PLANT | | | |

Table S8.2.2. Building categories, Hadnot Point–Holcomb Boulevard study area, U.S. Marine Corps Base Camp Lejeune, North Carolina, 2004 (from ECG, Inc. 1999).—Continued

| Category | Number of demand nodes | Building name/Narrative in building shapefile | Category | Number of demand nodes | Building name/Narrative in building shapefile |
|-------------------|------------------------|--|---------------|------------------------|---|
| Other (continued) | | STM/HEAT SHLTR TEMP. CBC CONTRACTOR TK TR/CR UN FAC TOILET (GOLF CRSE) TRHSG/DETACHED TT2 ELEMENTARY SIGN - ACTIVITY VENDOR SNACK STD(MAIN GATE) VISITORS-GUARD BUILDING WEATHER SHELTER (MAIN GATE) WELL HOUSE/DEEP WELL LCH-2 WELL NON PORT WATER TREATMENT PLANT II MEF LMCC VIC DRMO LOT 203 WEIGHING FAC (LOT201) WTR TREAT BLDG | Theater | 1 | BASE THEATER |
| | | | Swimming Pool | 2 | BATH HOUSE TT SWIMMING POOL INDOOR TRAINING POOL |
| | | | Training | 9 | TRNG AID PREP CTR CBT TRNG PL/TK OPERATIONAL TRAINER FACILITY COMBAT TRAIN POOL BACKWASH CAST OP TRAINER BLDG COVERED TRAINING AREA |
| | | | Unknown | 478 | |
| | | | Work Area | 278 | ACADEMIC INSTRUCTION BLDG ADMIN ADMIN BLDG, MWR MARKET OFFICE ADMIN FUEL FARM (HP) ADMIN --MWR PERSONNEL ADMIN OFC/PERS SPT STRG ADMIN OFF/JOINT RECEPT CTR ADMIN OFFICE TRAILER VIC 962 ADMIN OFFICE/CHAPEL ADMIN OFFICE/ELE COMM ADMIN SPACE ADMIN STEAM PLT ADMIN/INSTR ADMINISTRATION BUILDING ADMINISTRATIVE OFFICE APPLIED INSTRUCTION BUILDING BANK BARBER SHOP BASE HEADQUARTERS BATTALION AIDE STATION BATTALION ANNEX & COMPANY CP BATTLN SQUADRN HQ (MARCOR) BOAT SHOP CIVILIAN PERSONNEL OFFICE CLASSROOM CO/BTRY HDQTRS CO-BATTERY HQ COMBAT VEH MAINT SHOP COMMUNICATION CENTER COMPANY-BATTERY HQ DISPENSARY DRY CLEAN PLT/TAILOR SHOP EDUCATION SERV OFFICE ELEC COMM MAINT SHOP EXCH CTRL ADMIN FAMILY SERVICES CENTER FIELD MAINT SHOP FIRE TRNG CLASSROOM FSSG HDQTRS HAZ MAT MNGT CTR LEGAL SERVICES FACILITY LIBRARY MAINT SHOP STORES MAINTENANCE OFFICE MAINTENANCE SHOP MARINE FED CREDIT UNION MARSTON PAVILLION |
| Printing Services | 2 | PRINTING PLANT | | | |
| Rec. Center | 9 | COMMUNITY CENTER RECREATION CENTER YOUTH CENTER MULTIPURPOSE REC BLDG BEV CONT RE CTR YOUTH ACTIVITY | | | |
| School | 31 | building given in WCA | | | |
| Sports | 13 | FITNESS CENTER GYMNASIUM GYM-POST OFF INDOOR PLAYING COURT RACQUETBALL CT BASKETBALL COURT SQUASH COURT BOWLING ALLEY INDOOR HANDBALL COURT BASEBALL GRANDSTAND BLEACHERS FOOTBALL FIELD TENNIS COURT | | | |
| Storage | 83 | COMMUNITY STRG MISC DRUM RDY FUEL STORAGE GEN STG A/G/ORG GENERAL STORAGE GENERAL STORAGE SHED GOLF EQUIP BUILDING VIC 2015 GOLF EQUIP STORAGE VIC 1903 GROUNDS EQUIP SHED HAZ WASTE STOR FAC HAZARD/FLAM STOREHOUSE OP HAZARD/FLAM STORAGE PW MAINTENANCE STORAGE SAND STG BIN STG AIR/GRD ORG UTS MARCOR STG TK EL POT (BM) STGE/O/STOR MC STORAGE STORAGE BARN STORAGE BUILDING STORAGE SHELTER STRG A/G ORG MC-GEN WHSE MC STRG MAR CORPS | | | |

Table S8.2.2. Building categories, Hadnot Point–Holcomb Boulevard study area, U.S. Marine Corps Base Camp Lejeune, North Carolina, 2004 (from ECG, Inc. 1999).—Continued

| Category | Number of demand nodes | Building name/Narrative in building shapefile | Category | Number of demand nodes | Building name/Narrative in building shapefile |
|-------------------|----------------------------|---|--------------------------|------------------------|---|
| Work Area (cont.) | | MCCS MAINT OFFICE | Domino's Pizza | 1 | DOMINO'S PIZZA |
| | | MCX RETAIL SERVICE STA | Vehicle Washing | 52 | MCCS CAR WASH |
| | | MISC UTILITY PLANT BLDG | | | VEH WASH PLATFM(GOLF CRS) |
| | | MOCK-UP & TRNG AID PREP CNTR | | | building given in WCA |
| | | MWR SERVICE OUTLET | Warehouse | 28 | GEN WHSE BULK |
| | | NAVY FIELD MED SCHOOL BLDG | | | WAREHOUSE |
| | | NURSERY | | | GENERAL WAREHOUSE |
| | | OPS OFFICE | | | GEN WAREHOUSE NAVY |
| | | PARACHUTE/SURV EQUIP SHOP | | | WHSE SMU |
| | | POLICE STATION | | | GEN WHSE MC |
| | | POST OFFICE | | | MARCOR SASSY WH |
| | | PUBLIC TELE FAC | | | GEN PURP WHSE DSSC |
| | | PUBLIC WORK SHOP | | | MCX MAIN WHSE |
| | | PW SHOP (WTP/FC) | | | CIF & MCCS WAREHOUSE |
| | | REGMT GROUP HEADQUARTERS | CONTROLLED HUMIDITY WHSE | | |
| | | REHAB CTR D/A | | | |
| | | RELIGIOUS EDUCATION BLDG | | | |
| | | SINGLE MARINE PROGRAM | | | |
| | | SMALL ARMS SHOP | | | |
| | | SPL SER ISS OFFICE | | | |
| | THRIFT SHOP | | | | |
| | TROOP HSG EMERG BLDG | | | | |
| | WEAPONS SHOP | | | | |
| | WOODWORKING SHOP | | | | |
| | WORK FORCE LEARNING CENTER | | | | |

Appendix S8.3. Estimated Water Demand for the Holcomb Boulevard Water Treatment Plant Service Area

Table S8.3.1A. Bachelor housing consumption at Holcomb Boulevard water treatment plant service area, Hadnot Point–Holcomb Boulevard study area, U.S. Marine Corps Base Camp Lejeune, North Carolina, 1998.

[GPD, gallons per day; Data from ECG, Inc. 1999]

| Bachelor Housing | Population | % | GPD |
|-----------------------|--------------|------------|----------------|
| Bachelor Housing (CJ) | 1,648 | 88 | 108,010 |
| Bachelor Housing (PP) | 113 | 6 | 7,364 |
| Bachelor Housing (NH) | 110 | 6 | 7,364 |
| Total | 1,871 | 100 | 122,738 |

Note: CJ, Camp Johnson; PP, Paradise Point; NH, Naval Hospital (Figure S8.3)

Table S8.3.1B. Offices and work areas consumption at Holcomb Boulevard water treatment plant service area, Hadnot Point–Holcomb Boulevard study area, U.S. Marine Corps Base Camp Lejeune, North Carolina, 1998.

[ft², square feet; GPD, gallons per day; Data from ECG, Inc. 1999]

| Offices and work areas | Total area (ft ²) | % | GPD |
|----------------------------|-------------------------------|------------|---------------|
| Offices and Work Area (HB) | 96,090 | 14.5 | 5,188 |
| Offices and Work Area (TT) | 565,861 | 85.5 | 30,553 |
| Total | 661,951 | 100 | 35,741 |

Note: HB, Holcomb Boulevard Water-Distribution System; TT, Tarawa Terrace Water-Distribution System

Table S8.3.2A. Family housing consumption plus Irrigation at Holcomb Boulevard water treatment plant service area, Hadnot Point–Holcomb Boulevard study area, U.S. Marine Corps Base Camp Lejeune, North Carolina, 1998.

[GPD, gallons per day; Data from ECG, Inc. 1999]

| Family housing plus irrigation | GPD |
|--------------------------------|------------------|
| Family Housing (BM) | 208,806 |
| Family Housing (MP) | 137,574 |
| Family Housing (PP) | 175,404 |
| Family Housing (TT) | 454,915 |
| Family Housing (WV) | 104,492 |
| Family Housing (KM) | 5,993 |
| Total | 1,087,184 |

Note: BM, Berkeley Manor; MP, Midway Park; PP, Paradise Point; TT, Tarawa Terrace; WV, Watkins Village; KM, Camp Knox Trailer Park (Figure S8.3)

Table S8.3.2B. Heating plants consumption at Holcomb Boulevard water treatment plant service area, Hadnot Point–Holcomb Boulevard study area, U.S. Marine Corps Base Camp Lejeune, North Carolina, 1998.

[GPD, gallons per day; Data from ECG, Inc. 1999]

| Heating plant | GPD |
|--------------------|---------------|
| Heating Plant (HB) | 4,000 |
| Heating Plant (TT) | 10,000 |
| Total | 14,000 |

Note: HB, Holcomb Boulevard Water-Distribution System; TT, Tarawa Terrace Water-Distribution System

Table S8.3.2C. Tenants consumption at Holcomb Boulevard water treatment plant service area, Hadnot Point–Holcomb Boulevard study area, U.S. Marine Corps Base Camp Lejeune, North Carolina, 1998.

[GPD, gallons per day; Data from ECG, Inc. 1999]

| Tenants | GPD |
|--------------|----------------|
| Tenants (HB) | 114,209 |
| Tenants (TT) | 7,092 |
| Total | 121,301 |

Note: HB, Holcomb Boulevard Water-Distribution System; TT, Tarawa Terrace Water-Distribution System

Table S8.3.3. Node classification and demand for the present-day (2004) Holcomb Boulevard and Tarawa Terrace water-distribution system models, Hadnot Point–Holcomb Boulevard study area, U.S. Marine Corps Base Camp Lejeune, North Carolina.

[GPD, gallons per day; BM, Berkeley Manor; CJ, Camp Johnson; HB, Holcomb Boulevard; MP, Midway Park; NH, Naval Hospital; KM, Camp Knox Trailer Park; PP, Paradise Point; TT, Tarawa Terrace; WV, Watkins Village (Figure S8.3); Data from ECG, Inc. 1999]

| Demand group | Demand (GPD) | Category | Number of demand nodes | Distribution |
|---------------------------|------------------|-------------------|------------------------|------------------|
| Office and Work Area (HB) | 5,188 | Chapel | 1 | Area |
| | | Child Care | 4 | |
| | | Fire Station | 3 | |
| | | Gas Station | 1 | |
| | | Work Area | 4 | |
| | | Vehicle Washing | 1 | |
| | | Exchange | 1 | |
| Office and Work Area (TT) | 30,553 | Armory | 1 | Area |
| | | Chapel | 3 | |
| | | Clinic | 2 | |
| | | Child Care | 2 | |
| | | Fire Station | 1 | |
| | | Work Area | 84 | |
| | | Exchange | 3 | |
| | | School | 16 | |
| | | Printing Services | 1 | |
| Mess Hall (TT) | 14,502 | Mess Hall | 1 | Area |
| Cooling System (HB) | 13,886 | Cooling System | 1 | Cooling Capacity |
| Heating Plant (HB) | 4,000 | Heating Plant | 1 | Steam Production |
| Heating Plant (TT) | 10,000 | Heating Plant | 3 | Steam Production |
| Bachelor Housing (CJ) | 108,010 | Bachelor Housing | 24 | Area |
| Bachelor Housing (NH) | 7,364 | Bachelor Housing | 2 | Area |
| Bachelor Housing (PP) | 7,364 | Bachelor Housing | 10 | Area |
| Family Housing (BM) | 208,806 | Family Housing | 679 | Uniform |
| Family Housing (MP) | 137,574 | Family Housing | 416 | Uniform |
| Family Housing (PP) | 175,404 | Family Housing | 510 | Uniform |
| Family Housing (TT) | 454,915 | Family Housing | 1,763 | Uniform |
| Family Housing (WV) | 104,492 | Family Housing | 125 | Uniform |
| Family Housing (KM) | 5,993 | Family Housing | 28 | Uniform |
| Tenants (HB) | 114,209 | Naval Hospital | 7 | Known |
| | | Work Area | 2 | |
| | | Officers Club | 1 | |
| | | School | 9 | |
| | | Exchange | 1 | |
| Tenants (TT) | 7,092 | School | 6 | Known |
| | | Exchange | 2 | |
| None (HB) | 0 | Other | 15 | - |
| | | Storage | 1 | - |
| | | Club | 1 | - |
| | | Rec. Center | 2 | - |
| | | Unknown | 158 | - |
| None (TT) | 0 | Storage | 9 | - |
| | | Rec. Center | 1 | - |
| | | Swimming Pool | 2 | - |
| | | Unknown | 246 | - |
| | | Other | 10 | - |
| | | Sports | 4 | - |
| Total | 1,409,352 | | 4,168 | |

Appendix S8.4. Reconstruction of Operational Schedule of Booster Pump 742 Connecting the Hadnot Point and Holcomb Boulevard Water-Distribution Systems, Hadnot Point–Holcomb Boulevard Study Area, U.S. Marine Corps Base Camp Lejeune, North Carolina

By Ilker T. Telci, Jason Sautner, Morris L. Maslia, and Mustafa M. Aral

Authors

Ilker T. Telci, PhD

Post-Graduate Research Fellow

Oak Ridge Institute for Science and Education
Agency for Toxic Substances and Disease Registry
Atlanta, Georgia

Jason B. Sautner, MSCE, EIT

Environmental Health Scientist

Division of Community and Health Investigations
Agency for Toxic Substances and Disease Registry
Atlanta, Georgia

Morris L. Maslia, MSCE, PE, D.WRE, DEE

Research Environmental Engineer and Project Officer

Exposure-Dose Reconstruction Project
Division of Community Health Investigations
Agency for Toxic Substances and Disease Registry
Atlanta, Georgia

Mustafa M. Aral, PhD, PE, Phy

Director and Professor

Multimedia Environmental Simulations Laboratory
School of Civil and Environmental Engineering
Georgia Institute of Technology
Atlanta, Georgia

Contents

| | |
|----------------------|--------|
| Authors | S8.172 |
| Abstract..... | S8.174 |
| Introduction..... | S8.174 |
| Available Data | S8.176 |
| Methodology..... | S8.176 |
| Results | S8.181 |
| Conclusions..... | S8.184 |
| References..... | S8.184 |

Figures

| | |
|--|--------|
| S8.4.1. Map showing the Hadnot Point and Holcomb Boulevard water treatment plant (WTP) service areas, Hadnot Point–Holcomb Boulevard study area, U.S. Marine Corps Base Camp Lejeune, North Carolina..... | S8.175 |
| S8.4.2. Graphs showing available data for the Hadnot Point–Holcomb Boulevard study area, U.S. Marine Corps Base Camp Lejeune, North Carolina, 1972–1986..... | S8.177 |
| S8.4.3. Directed graph for the state transitions | S8.178 |
| S8.4.4. Directed graph with conditional transition probabilities | S8.179 |
| S8.4.5. Graph showing comparison of yearly predicted number of transfer events with the observations for the case including September, Hadnot Point–Holcomb Boulevard study area, U.S. Marine Corps Base Camp Lejeune, North Carolina, 1972–1986..... | S8.182 |
| S8.4.6. Graph showing comparison of yearly predicted number of transfer events with the observations for the case excluding September, Hadnot Point–Holcomb Boulevard study area, U.S. Marine Corps Base Camp Lejeune, North Carolina, 1972–1986..... | S8.182 |
| S8.4.7. Graph showing comparison of monthly predicted number of transfer events with the observations for the case including September, Hadnot Point–Holcomb Boulevard study area, U.S. Marine Corps Base Camp Lejeune, North Carolina, 1972–1986..... | S8.183 |
| S8.4.8. Graph showing comparison of monthly predicted number of transfer events with the observations for the case excluding September, Hadnot Point–Holcomb Boulevard study area, U.S. Marine Corps Base Camp Lejeune, North Carolina, 1972–1986..... | S8.183 |

Tables

| | |
|---|--------|
| S8.4.1. Number of state transitions of booster pump 742 operation and their prior probabilities, Hadnot Point–Holcomb Boulevard study area, U.S. Marine Corps Base Camp Lejeune, North Carolina, 1978–1986 | S8.178 |
| S8.4.2. Statistical analysis of the yearly predictions of transfer events and comparison with the observations for the case including September, Hadnot Point–Holcomb Boulevard study area, U.S. Marine Corps Base Camp Lejeune, North Carolina, 1972–1986..... | S8.182 |
| S8.4.3. Statistical analysis of the yearly predictions of transfer events and comparison with the observations for the case excluding September, Hadnot Point–Holcomb Boulevard study area, U.S. Marine Corps Base Camp Lejeune, North Carolina, 1972–1986..... | S8.182 |

Reconstruction of Operational Schedule of Booster Pump 742 Connecting the Hadnot Point and Holcomb Boulevard Water-Distribution Systems, Hadnot Point–Holcomb Boulevard Study Area, U.S. Marine Corps Base Camp Lejeune, North Carolina

By Ilker T. Telci, Jason Sautner, Morris L. Maslia, and Mustafa M. Aral

Abstract

The Agency for Toxic Substances and Disease Registry is conducting a historical reconstruction study to determine the contamination levels in the drinking water supplied by Holcomb Boulevard and Hadnot Point water-distribution systems in the U.S. Marine Corps Base Camp Lejeune, North Carolina. These two water-distribution systems are connected by booster pump 742, and available data indicate that this booster pump was operated intermittently, causing some transfers of finished water between the two water-distribution systems. Therefore, information on historical operational schedule of this booster pump is required for the accurate estimation of contamination levels in the drinking water supplied by the two water-distribution systems. For this study, a methodology was developed to estimate the number of booster pump opening events in the past on a yearly basis. Then, these yearly numbers of events were distributed among the dry months in each year. The available data consist of daily recordings of temperature and precipitation in the Hadnot Point–Holcomb Boulevard (HPHB) study area and finished water delivered from the Holcomb Boulevard water treatment plant (HBWTP). The amount of the water transfer through booster pump 742 is also available for some limited number of days.

In this study, a probabilistic approach based on Markov Chain simulations was used to estimate the yearly numbers of booster pump openings. For the calculation of transition probabilities of this Markov Chain model, the conditional probabilities of transfer events¹ given the temperature, precipitation, or delivered finished-water volume value in a day were calculated using Kernel density estimator and Bayes' theorem. Also, the probabilities of transfer were conditioned on the values of pairs of the aforementioned parameters by using the Copula concept. This methodology is an efficient and effective way of utilizing the available data to predict the number of booster pump openings on a monthly basis. The results show that the predictions of the methodology are reasonable and the outcomes are ready to be used in contaminant fate and transport simulations for the Holcomb Boulevard and Hadnot Point water-distribution systems.

¹ The terms “transfer events” and “booster pump openings” are used interchangeably throughout this report

Introduction

The Agency for Toxic Substances and Disease Registry (ATSDR) is conducting epidemiological studies to evaluate the potential for health effects from exposures to volatile organic compounds (VOCs) in finished water supplied to family housing units at U.S. Marine Corps Base Camp Lejeune, North Carolina (USMCB Camp Lejeune). USMCB Camp Lejeune, which has been used as a military training facility since 1942, is located in Onslow County in the central part of the North Carolina Coastal Plain as shown in Figure S8.4.1. The camp is located south of the City of Jacksonville and 70 miles northeast of the City of Wilmington.

The historical reconstruction of contaminant fate and transport in groundwater of Tarawa Terrace area of Camp Lejeune and contamination levels of the drinking water supplied by Tarawa Terrace water treatment plant has been extensively studied by ATSDR in previous analyses and reports (Maslia et al. 2007a, b; Wang and Aral 2008; Maslia et al. 2009). Current (2012) studies focus on historical reconstruction of contamination levels in the Holcomb Boulevard and Hadnot Point water-distribution systems. This reconstruction process requires gathering information about the groundwater system, characterization of contaminant sources, and simulation of contaminant fate and transport in the groundwater system and the water-distribution systems serving the HPHB study area. The water-distribution systems are connected by booster pump 742 which conveys water from the Hadnot Point water-distribution system to the Holcomb Boulevard water-distribution system. Therefore, information on the operational schedule of this booster pump is a prerequisite for the simulation of water flow and contaminant fate and transport in the water-distribution systems of these study areas.

The purpose of this part of the project is to reconstruct the operational schedule of the booster pump connecting the Hadnot Point water-distribution system to the Holcomb Boulevard water-distribution system during the dry months of each year—April, May, June, July, August, and September. The predicted daily operation of this booster pump will be used as input data to the contaminant transport model for Hadnot Point and Holcomb Boulevard water-distribution systems.

Detailed daily data about the operational schedule of the booster pump are available for the years 1978, 1980,

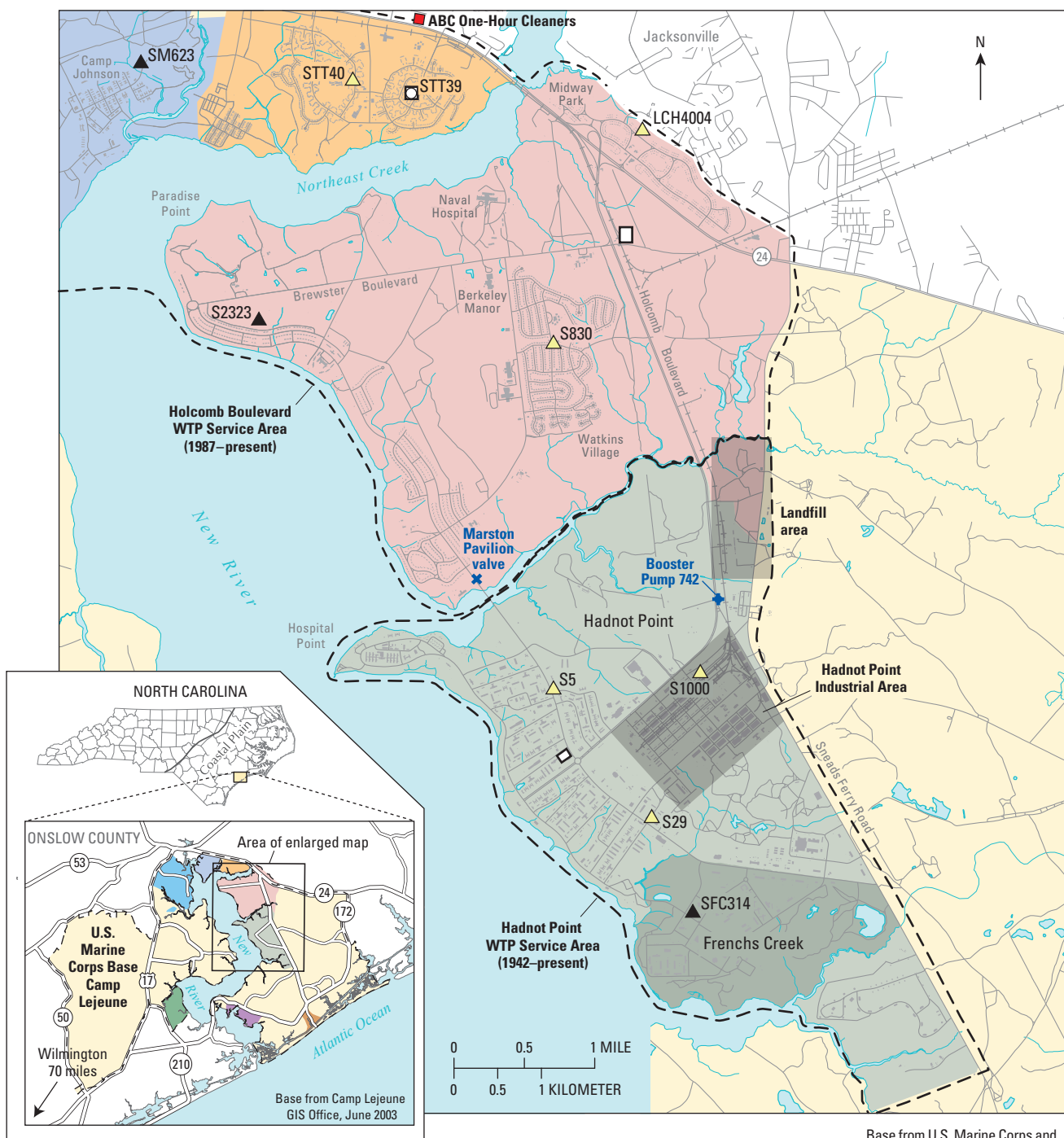

Historical water-supply areas of Camp Lejeune Military Reservation

- Montford Point
- Tarawa Terrace
- Holcomb Boulevard
- Hadnot Point
- Other areas of Camp Lejeune Military Reservation
- New River Air Station
- Rifle Range
- Courthouse Bay
- Onslow Beach

EXPLANATION

- Water treatment plant—
Name and length of operation
Hadnot Point: 1942–present
Holcomb Boulevard:
June 1972–present
Tarawa Terrace: 1952–1987

Base from U.S. Marine Corps and U.S. Geological Survey digital data files

- Storage tank and identifier**
- ▲ SFC314 Elevated—Controlling
- ▲ S5 Elevated
- STT39 Ground—Finished water

Figure S8.4.1. The Hadnot Point and Holcomb Boulevard water treatment plant (WTP) service areas, Hadnot Point–Holcomb Boulevard study area, U.S. Marine Corps Base Camp Lejeune, North Carolina.

1983, 1984, 1985, and 1986. For all other years between 1972 and 1986, limited or no information is available about the operation of the booster pump. Besides the operational data, daily values of high and low temperatures, precipitation, and delivered finished-water flows from the HBWTP are available. In this study, a probabilistic methodology based on a Markov Chain model was developed for the prediction of daily operational schedules of booster pump 742 by using the available data.

Available Data

Figure S8.4.2A shows how minimum (T_{\min}) and maximum (T_{\max}) temperatures (in degrees Fahrenheit) change with time from 1972 to 1986. The gray shaded areas represent the non-dry and typically lower water demand months (October–March) excluded from the analysis. Figure S8.4.2B shows the daily variation of precipitation, I , (in inches) in the study area. Figure S8.4.2C illustrates the delivered finished-water volume, V (in millions of gallons), by the HBWTP. Because monthly delivered finished-water flows are available, this figure shows a constant average daily volume for the days of a given month. The known daily operational schedule of booster pump 742 and the days when a prediction is needed from the results of this study are shown in Figure S8.4.2D. In Figure S8.4.2D, a positive value of water transferred, including zero, indicates that the booster pump's schedule is known for that day. If this value is zero, the booster pump is closed; a positive value of water transferred indicates that the booster pump is open on that day. A negative value of water transferred (-1) indicates that a prediction is needed for that date.

When data in Figure S8.4.2 are closely analyzed, one can see that although high and low temperatures have significant daily fluctuations, their trends and average values are similar on a yearly basis. Similar observations can be made for the precipitation data. However, delivered finished-water volume data have significant monthly and yearly variations. The aforementioned trends are important in correlating climatic- and consumptive-related parameters with booster pump openings. When booster pump 742 operational data are examined (Figure S8.4.2D), it is observed that the number of water-transfer events in a year increases as the delivered finished-water volume by the HBWTP increases. However, similar observations cannot be made for climatic, temperature and precipitation, parameters (Figures S8.4.2A and S8.4.2B, respectively).

Methodology

In this study, a discrete-time Markov Chain model is used for the historical reconstruction of booster pump 742 operations. A Markov Chain is a stochastic process, which goes through transitions from one state to another such that the conditional probability distribution of any future state is independent of the past states and depends only on the present state (Ross 1997). Markov Chains are extensively used in a wide variety of disciplines such as statistics (Avery and Henderson 1999; Setti et al. 2002), pattern recognition (Dai et al. 1991), economics (Elliott et al. 1998), communications engineering (Krieger et al. 1990), ecological studies (Balzter 2000; Logofet and Lesnaya 2000), geological studies (Norberg et al. 2002), health (McDonnell et al. 2002), biology (Gani and Stals 2004; Sano et al. 2004), parameter estimation (Ahmed et al. 1998), physics (Degweker 1997), and epidemiology (Ranta et al. 2004).

In this study, a two-state Markov Chain is used (Figure S8.4.3) wherein numbers indicate states, directed arcs represent the transitions from one state to the other, and P_{ij} stands for the transition probability from state i to state j . In Figure S8.4.3, zero state represents an event when the booster pump is closed, and a state value of 1 indicates a water-transfer event from the Hadnot Point water-distribution system to the Holcomb Boulevard water-distribution system.

The first step in a Markov Chain analysis is to determine the transition probabilities. The prior transition probabilities can be determined from the numbers of transition events in the available data as shown in Equation S8.4.1.

$$P_{ij} = \frac{N_{ij}}{\sum_{j=0}^1 N_{ij}}, \quad (\text{S8.4.1})$$

where N_{ij} represents the number of consecutive transitions from state i to state j . Table S8.4.1 provides the number of state transitions for booster pump 742 operation and their prior probabilities. The reasons these probabilities are called “prior” is because (1) they depend only on the observed transitions and (2) they are independent of the available temperature, precipitation, and delivered finished-water volume observations. However, the methodology proposed for this study is based on linking the transition probabilities with the observed temperature, precipitation, and delivered finished-water volume data in

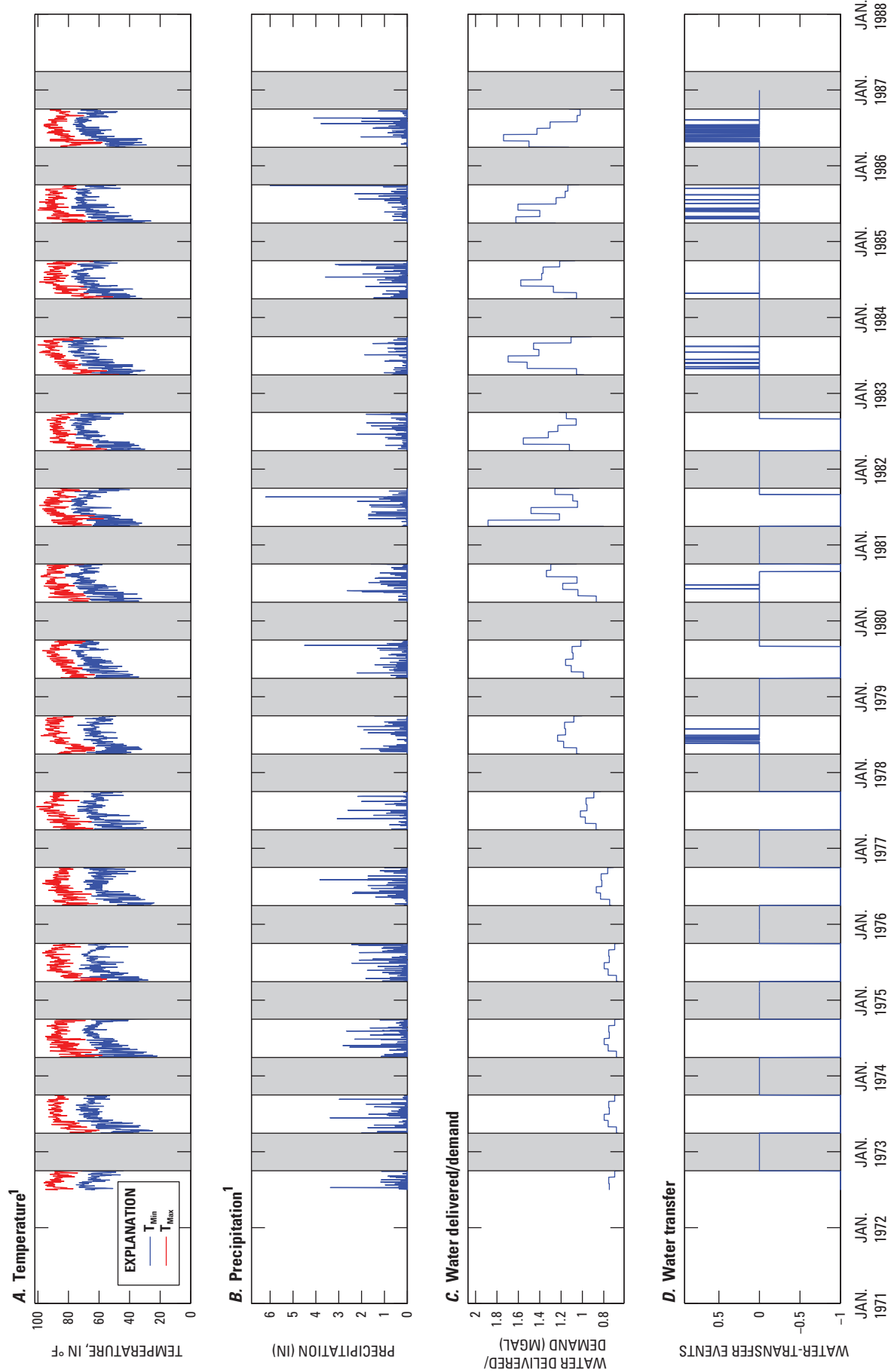

Figure S8.4.2. Available data for the Hadnot Point–Holcomb Boulevard study area, U.S. Marine Corps Base Camp Lejeune, North Carolina, 1972–1986.

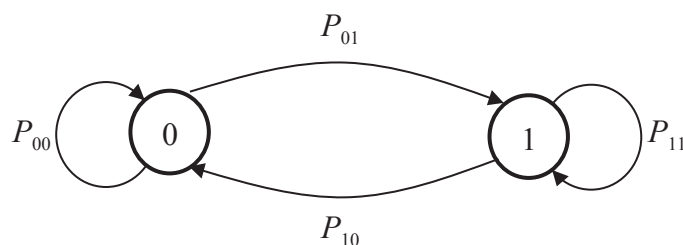

Figure S8.4.3. Directed graph for the state transitions.

Table S8.4.1. Number of state transitions of booster pump 742 operation and their prior probabilities, Hadnot Point–Holcomb Boulevard study area, U.S. Marine Corps Base Camp Lejeune, North Carolina, 1978–1986.

| Transitions | Number of transitions (N_{ij}) | Prior transition probabilities (P_{ij}) |
|--------------------|------------------------------------|---|
| 0-0 ($i=0, j=0$) | 1,028 | 0.96 |
| 0-1 ($i=0, j=1$) | 41 | 0.04 |
| 1-0 ($i=1, j=0$) | 41 | 0.49 |
| 1-0 ($i=1, j=1$) | 42 | 0.51 |

a bivariate manner. For this purpose, conditional transitional probabilities need to be obtained. The first step in this process is to determine the conditional probability density functions of low and high temperatures, precipitation, and delivered finished-water volume given a transition by applying the non-parametric Kernel density estimator to the observed data. If these probability density functions are represented by $f(\Phi = \varphi | i-j)$ where Φ is a generic variable which indicates one of the four parameters (e.g., T_{\max} , T_{\min} , I, or V), φ stands for a specific value of this parameter, and $i-j$ represents a given transition from state i to state j (i, j can take the values of 0 and 1), then one can calculate the conditional probabilities of transitions given value of a parameter, i.e., $P(i-j | \Phi = \varphi)$ as shown in Equation S8.4.2 using Bayes' Theorem. Next, the transition probabilities in the directed graph for the two-state Markov Chain shown in Figure S8.4.3 can be modified as indicated in Figure S8.4.4. It should be noted that values of these transition probabilities are not constant and change their value according to the daily observations of temperature, precipitation, and delivered finished-water volume by the HBWTP.

$$P(i-j | \Phi = \varphi) = \frac{f(\Phi = \varphi | i-j) P_{ij}}{\sum_{j=0}^1 [f(\Phi = \varphi | i-j) P_{ij}]} \quad (\text{S8.4.2})$$

In this representation of transition probabilities, the probability depends on only one selected parameter. In order to involve a pair of parameters such as T_{\max} and V or I and V, a copula method can be used to estimate the joint conditional density functions of these parameters given the known transitions in the available dataset. The Copula method is a widely used approach to determine the joint probability distribution of two random variables. The following examples are noteworthy. Shiao (2006) used copulas to find a relation between drought duration and its severity. Zhang and Singh (2006) applied the copula method to find the joint cumulative distribution function of flood volume and discharge in addition to flood volume and flood duration. Copulas were also used to demonstrate the relation between air-quality parameters (Singh and Zhang 2005) and water-resources studies (De Michele et al. 2005).

In this study described herein, a bivariate copula is used to estimate the joint probability density function between any pair of the parameters (i.e., T_{\max} , T_{\min} , I, and V). If any selected parameter is represented by Φ_1 and the other is represented by Φ_2 , then $f(\Phi_1 = \varphi_1, \Phi_2 = \varphi_2 | i-j)$ indicates the joint conditional probability density function of this pair of parameters given the transition is from state i to state j . In this study, this joint probability density function is calculated by using the MatLab® copula function which utilizes the Frank copula (MatLab 2012). Once these joint conditional probability density functions are estimated, the conditional transition probabilities can be determined by using Bayes' Theorem as shown in Equation S8.4.3.

$$P(i-j | \Phi_1 = \varphi_1, \Phi_2 = \varphi_2) = \frac{f(\Phi_1 = \varphi_1, \Phi_2 = \varphi_2 | i-j) P_{ij}}{\sum_{j=0}^1 [f(\Phi_1 = \varphi_1, \Phi_2 = \varphi_2 | i-j) P_{ij}]} \quad (\text{S8.4.3})$$

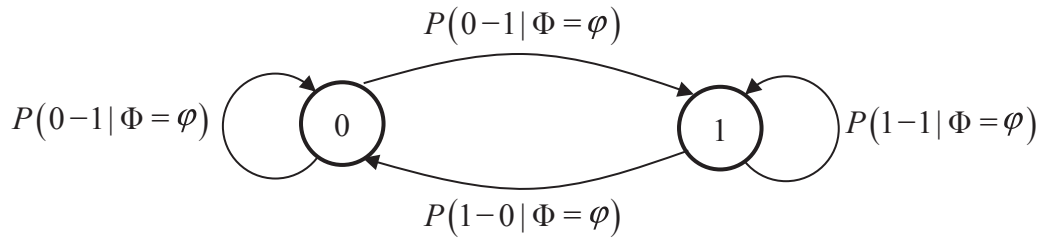

Figure S8.4.4. Directed graph with conditional transition probabilities.

In order to obtain a better representation of the available data, previous 10-day averages of the parameters were used in addition to the single value of the parameters for a given day to calculate the transition probabilities. Once the procedure to determine the transition probabilities is established, the next step is to simulate a Markov Chain by using the transient transition probabilities. If a single value from each parameter is used, the Markov Chain simulation starts at the first day of the analysis period (July 1, 1972) with a closed booster pump orientation (i.e., 0 status). Then a binary random number, which has a value of either 1 or 0, is generated. In this random number generation process, if the current booster pump status is closed (i.e., 0 status), then the random number is generated such that while the probability of getting a 0 is $P(0-0|\Phi=\varphi)$ and the probability of generating a 1 is $P(0-1|\Phi=\varphi)$. Similarly, if the current booster pump status is open (i.e., 1 status), then the random number is generated such that while the probability of getting a 0 is $P(1-0|\Phi=\varphi)$, the probability of generating a 1 is $P(1-1|\Phi=\varphi)$. This random number generation process continues for every day of the dry months (April–September) for 1972–1986. At the beginning of every dry month period (i.e., July 1 for 1972 and April 1 for all other years), the status of the booster pump is assumed to be 0. When the algorithm generates a binary random number for all of the days in the analysis period, one Markov Chain simulation is completed, and the binary number (0 and 1) assigned to each day represents the prediction of booster pump 742 state on that day.

Markov Chain simulations are flexible tools in generating time series of data. One of these flexibilities comes from the fact that hidden Markov layers can be introduced in the prediction process. In this study, a 10-layer hidden Markov Chain was used to predict the daily operational status of booster pump 742. The first day of a 10-layer Markov Chain starts on July 11, 1972. Then a single-layer Markov simulation utilizing the data from the previous 10 days (assuming 0 status) is used to make a state prediction. Then another single-layer Markov simulation utilizing the data from the previous 9 days and assuming the current state of the booster pump as the previously predicted state is used to make another state prediction. This continues for 10 single-layer Markov simulations. The result of tenth Markov simulation was the predicted booster pump operational status on July 1, 1972. For the next day, similar Markov simulations are performed by using the data starting from the previous 10 days.

These single- or 10-layer Markov Chain simulations generate time series of predicted booster pump openings. However, because this method is probabilistic, another simulation using the same Markov Chain may predict a different booster pump 742 schedule. As a consequence, in this study, rather than reporting the predictions of one Markov Chain simulation, a statistical analysis which examines the result of multiple simulations is carried out. For the statistical analysis, 1,000 Markov Chains are simulated, and the mean value of number of daily booster pump openings predicted in the dry month periods of each year y is calculated as N_y . In order to understand this averaging process, let N_{MS} be the total number of Markov Chain simulations (which is 1,000 in this case), and let s_d^i represent the predicted booster pump status (i.e., 0 for closed and 1 for open) on day d in the i^{th} Markov Chain simulation. Then, the average number of daily booster pump openings in year y , N_y , can be calculated by using Equation S8.4.4.

$$N_y = \frac{1}{N_{MS}} \sum_{i=1}^{N_{MS}} \sum_{\forall d \text{ in } y} s_d^i \quad (\text{S8.4.4})$$

Once the annual number of booster pump opening events in a given year is predicted, then the next step is to distribute this number of events over the dry months of a particular year. This distribution process is achieved by using a probabilistic approach. For this purpose, first, the available precipitation (I) and delivered finished-water volume (V) data are used to estimate the conditional joint probability distribution functions of these parameters to obtain the values of v and w given whether the booster pump is open ($f(I=w, V=v|1)$) or closed ($f(I=w, V=v|0)$). These probability density functions are estimated by using the Kernel density estimation method in conjunction with the Copula concept. Then, the Bayes' Theorem given in Equation S8.4.5 is applied in order to find the conditional probability of a water-transfer event (i.e., booster pump status is 1) given the values of precipitation (I) and delivered finished-water volume (V) on a daily basis.

$$P^d(1|I=w, V=v) = \frac{f(I=w, V=v|1)P_1}{f(I=w, V=v|0)P_0 + f(I=w, V=v|1)P_1}, \quad (\text{S8.4.5})$$

where P_0 and P_1 are prior probabilities of having the booster pump closed or open, respectively. These prior probabilities are calculated by using the number of known booster pump states in the available data. The next step in the distribution process is to find the average monthly values of these conditional probabilities by using Equation S8.4.6.

$$P_{av}^m = \frac{1}{N_d^m} \sum_{\substack{\text{day } d \text{ is} \\ \text{in month } m}} P^d(1|I=w, V=v), \quad (\text{S8.4.6})$$

where N_d^m is the number of days in month m . It should be noted that yearly sum of these monthly average probabilities does not add up to 1 for a given year y . Thus, a normalization process is needed for accurate distribution of yearly number of predicted transfer events as shown in Equation S8.4.7.

$$P_{norm}^m = \frac{P_{av}^m w_m}{\sum_{\substack{\text{month } m \text{ is} \\ \text{in year } y}} P_{av}^m w_m}, \quad (\text{S8.4.7})$$

where P_{norm}^m is the normalized monthly probability and w_m is the weighting coefficient for month m . These weighting coefficients are determined by using a probabilistic approach as well. For this purpose, the Kernel density estimator is used to find the conditional probability density functions of precipitation (I) to obtain the value of w given whether the booster pump is open ($f(I=w|1)$) or closed ($f(I=w|0)$). Then the Bayes' Theorem given in Equation S8.4.8 is applied in order to find the conditional probability of a water-transfer event (i.e., booster pump status is 1), given the values of precipitation (I) on a daily basis.

$$P^d(1|I=w) = \frac{f(I=w|1)P_1}{f(I=w|0)P_0 + f(I=w|1)P_1} \quad (\text{S8.4.8})$$

Then, these daily probabilities are averaged out for each month (Equation S8.4.9) and normalized with respect to their yearly sum (Equation S8.4.10).

$$P_{av|I}^m = \frac{1}{N_d^m} \sum_{\substack{\text{day } d \text{ is} \\ \text{in month } m}} P^d (1|I=w) \text{ and } \quad (\text{S8.4.9})$$

$$P_{norm|I}^m = \frac{P_{av|I}^m}{\sum_{\substack{\text{month } m \text{ is} \\ \text{in year } y}} P_{av|I}^m}, \quad (\text{S8.4.10})$$

where $P_{av|I}^m$ is the monthly average probability obtained from precipitation (I) only and $P_{norm|I}^m$ is the monthly normalized probability obtained from precipitation (I) only. The monthly weighting coefficients are calculated as the square of these monthly normalized probabilities obtained from precipitation (I) only, that is $w_m = (P_{norm|I}^m)^2$.

Then, the monthly number of water-transfer events is calculated by multiplying the mean values of number of yearly water-transfer events with the normalized monthly average probabilities and rounding the result to the nearest integer as shown in Equation S8.4.11.

$$N_T^m = \text{round}(P_{norm}^m N_y) \quad (\text{S8.4.11})$$

As the final step of the monthly distribution process, the summation of monthly number of water-transfer events for each year y is compared to the annual number of booster pump opening events predicted for that year, as in Equation S8.4.12.

$$r_y = N_y - \sum_{\substack{\text{month } m \text{ is} \\ \text{in year } y}} N_T^m, \quad (\text{S8.4.12})$$

where r_y represents the difference between the summation of monthly number of water-transfer events for each year y and the annual number of booster pump opening events predicted for that year. If r_y is positive, then the month with the maximum normalized monthly average probability (P_{norm}^m) is determined and the monthly number of water-transfer events for this month is increased by r_y . If r_y is negative, then the month with the minimum normalized monthly average probability (P_{norm}^m) and a non-zero monthly number of water-transfer events is determined and the monthly number of water-transfer events for this month is decreased by 1, and this process is repeated until r_y becomes zero. As a result, the summation of final monthly number of water-transfer events for each year y is always equal to the annual number of booster pump opening events predicted for that year.

Results

In this study, it is observed that a 10-layer Markov Chain using the 10-day average data provides better predictions than a single Markov Chain. Moreover, the conditional joint probability density function between the precipitation (I) and the delivered finished-water volume (V) obtained from the copula method provides better prediction performance. Thus, this report provides the results of 10-layer Markov Chain simulations in which the transition probabilities are obtained by using the joint conditional probabilities between 10-day average-data pairs of precipitation (I) and the delivered finished-water volume (V). Also, the methodology is tested by both including and excluding the month September in the analysis. Thus, the dry months always include April, May, June, July, and August, and may include September. Tables S8.4.2 and S8.4.3 show the yearly prediction results of transfer events including and excluding September, respectively. In these tables, the predictions can be compared with the observations. These tables also provide statistical information about the Markov Chain simulations, such as the minimum and maximum number of transfer events in each year. Here, the mean value represents the average number of daily booster pump openings in every year (N_y). Also, the standard deviation of the number of yearly transfer events for each year is reported.

Yearly results listed in Tables S8.4.2 and S8.4.3 as the mean number of transfer events in 1,000 Markov Chain simulations can be rounded to the nearest integer, thereby providing the predicted annual number of transfer events. The yearly predictions and the observed annual number of transfer events are shown graphically in Figures S8.4.5 and S8.4.6 for the cases including and excluding September, respectively. In these figures, the bars and corresponding numbers represent the number of predicted booster pump openings (transfer events) in each year. The circle symbols and corresponding numbers represent the number of observed transfer events during years when data are available. In Figures S8.4.5 and S8.4.6, the maximum number of predicted transfer events occurs in 1981. This year also has the maximum delivered finished-water volume (Figure S8.4.2C). Although it is intuitively known that the number of events is inversely proportional to the precipitation amounts, this effect is not evident in Figure S8.4.2. However, the effect of delivered finished-water volume by the HBWTP is evident. Therefore, the few predicted number of booster pump opening events between 1972 and 1976 can be attributed to the low delivered finished-water volume by the HBWTP.

In the next step of the analysis, the yearly predicted booster pump opening events are distributed to the months of each corresponding year by using a probabilistic approach explained in the previous section. Figures S8.4.7 and S8.4.8 show monthly predicted number of booster pump opening events and corresponding observations for the cases including and excluding September, respectively. In Figures S8.4.7 and S8.4.8, the bars represent the number of predicted booster pump opening events in each month, and the circles represent the number of observed booster pump opening events in each month.

Table S8.4.2. Statistical analysis of the yearly predictions of transfer events and comparison with the observations for the case including September, Hadnot Point–Holcomb Boulevard study area, U.S. Marine Corps Base Camp Lejeune, North Carolina, 1972–1986.

| Year | Number of transfer events | | | | |
|------|---------------------------|--------------|--------------|-------|-----------------------|
| | Observation* | Mini- mum | Maxi- mum | Mean | Standard deviation |
| 1972 | N/A | 0 | 12 | 0.60 | 1.39 |
| 1973 | N/A | 0 | 19 | 2.62 | 3.57 |
| 1974 | N/A | 0 | 14 | 2.04 | 2.42 |
| 1975 | N/A | 0 | 16 | 2.07 | 2.60 |
| 1976 | N/A | 0 | 21 | 1.73 | 2.41 |
| 1977 | N/A | 0 | 26 | 5.09 | 3.80 |
| 1978 | 16 | 0 | 23 | 6.39 | 3.91 |
| 1979 | N/A | 0 | 19 | 4.43 | 2.69 |
| 1980 | 4 | 0 | 27 | 6.70 | 3.83 |
| 1981 | N/A | 16 | 48 | 26.76 | 4.69 |
| 1982 | N/A | 0 | 33 | 10.93 | 5.12 |
| 1983 | 7 | 3 | 39 | 16.60 | 6.34 |
| 1984 | 1 | 0 | 32 | 11.65 | 5.13 |
| 1985 | 20 | 1 | 33 | 15.50 | 5.90 |
| 1986 | 35 | 2 | 46 | 19.72 | 7.01 |

*Data from Camp Lejeune water utility log books, Camp Lejeune Water Documents CLW #7203–#8735.

Table S8.4.3. Statistical analysis of the yearly predictions of transfer events and comparison with the observations for the case excluding September, Hadnot Point–Holcomb Boulevard study area, U.S. Marine Corps Base Camp Lejeune, North Carolina, 1972–1986.

| Year | Number of transfer events | | | | |
|------|---------------------------|--------------|--------------|-------|-----------------------|
| | Observation* | Mini- mum | Maxi- mum | Mean | Standard deviation |
| 1972 | N/A | 0 | 7 | 0.08 | 0.44 |
| 1973 | N/A | 0 | 12 | 0.59 | 1.69 |
| 1974 | N/A | 0 | 12 | 0.45 | 1.17 |
| 1975 | N/A | 0 | 10 | 0.41 | 1.23 |
| 1976 | N/A | 0 | 19 | 0.99 | 1.95 |
| 1977 | N/A | 0 | 23 | 4.73 | 3.75 |
| 1978 | 16 | 0 | 24 | 7.73 | 4.25 |
| 1979 | N/A | 0 | 21 | 5.86 | 3.12 |
| 1980 | 4 | 0 | 19 | 5.69 | 3.59 |
| 1981 | N/A | 8 | 43 | 24.23 | 4.95 |
| 1982 | N/A | 1 | 35 | 12.41 | 5.50 |
| 1983 | 7 | 2 | 37 | 15.83 | 6.05 |
| 1984 | 1 | 0 | 31 | 11.20 | 4.72 |
| 1985 | 19 | 3 | 37 | 16.26 | 5.94 |
| 1986 | 35 | 3 | 46 | 20.23 | 7.10 |

*Data from Camp Lejeune water utility log books, Camp Lejeune Water Documents CLW #7203–#8735.

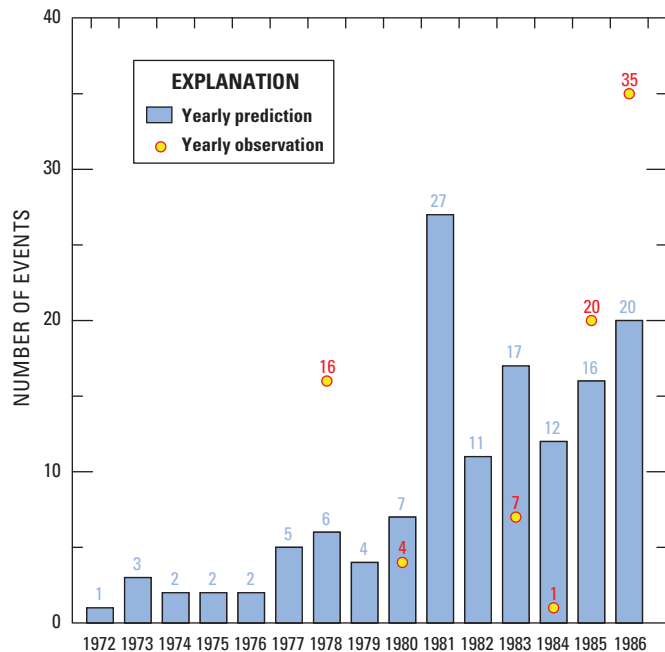

Figure S8.4.5. Comparison of yearly predicted number of transfer events with the observations for the case including September, Hadnot Point–Holcomb Boulevard study area, U.S. Marine Corps Base Camp Lejeune, North Carolina, 1972–1986.

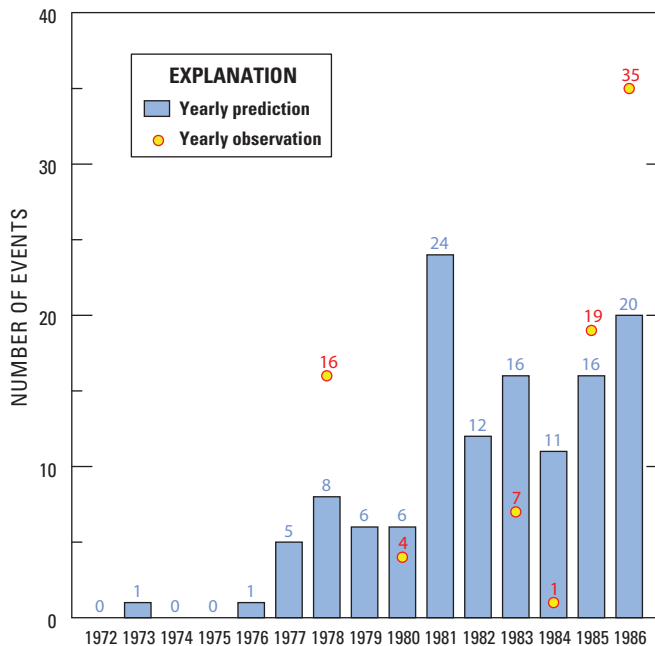

Figure S8.4.6. Comparison of yearly predicted number of transfer events with the observations for the case excluding September, Hadnot Point–Holcomb Boulevard study area, U.S. Marine Corps Base Camp Lejeune, North Carolina, 1972–1986.

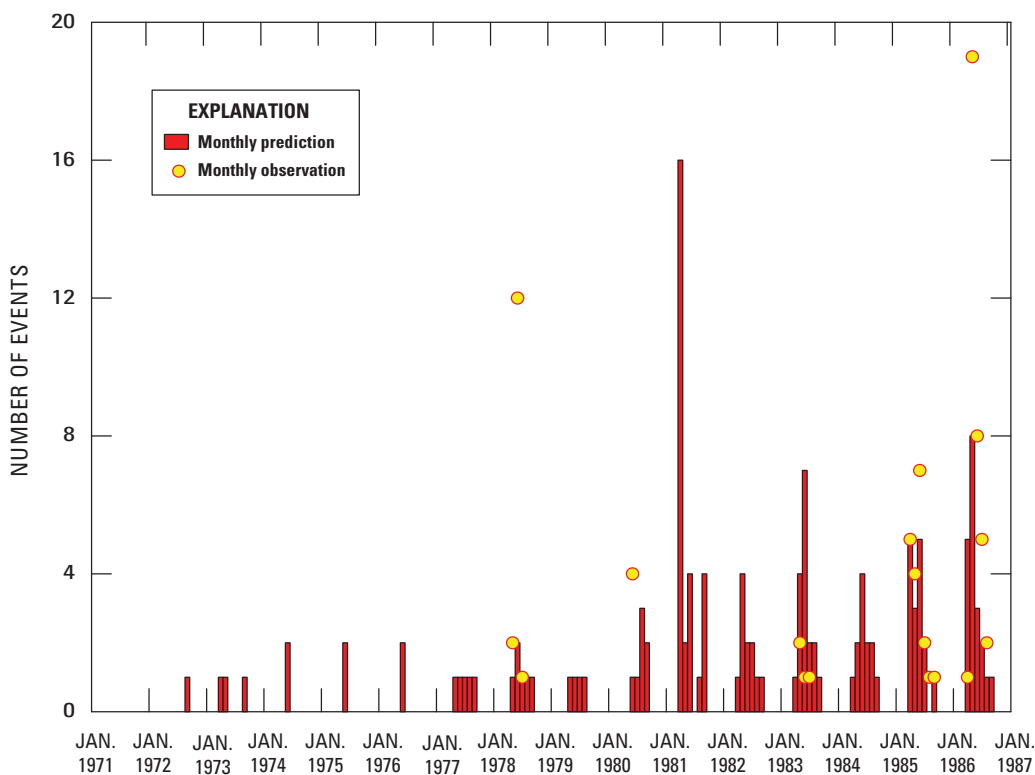

Figure S8.4.7. Comparison of monthly predicted number of transfer events with the observations for the case including September, Hadnot Point–Holcomb Boulevard study area, U.S. Marine Corps Base Camp Lejeune, North Carolina, 1972–1986.

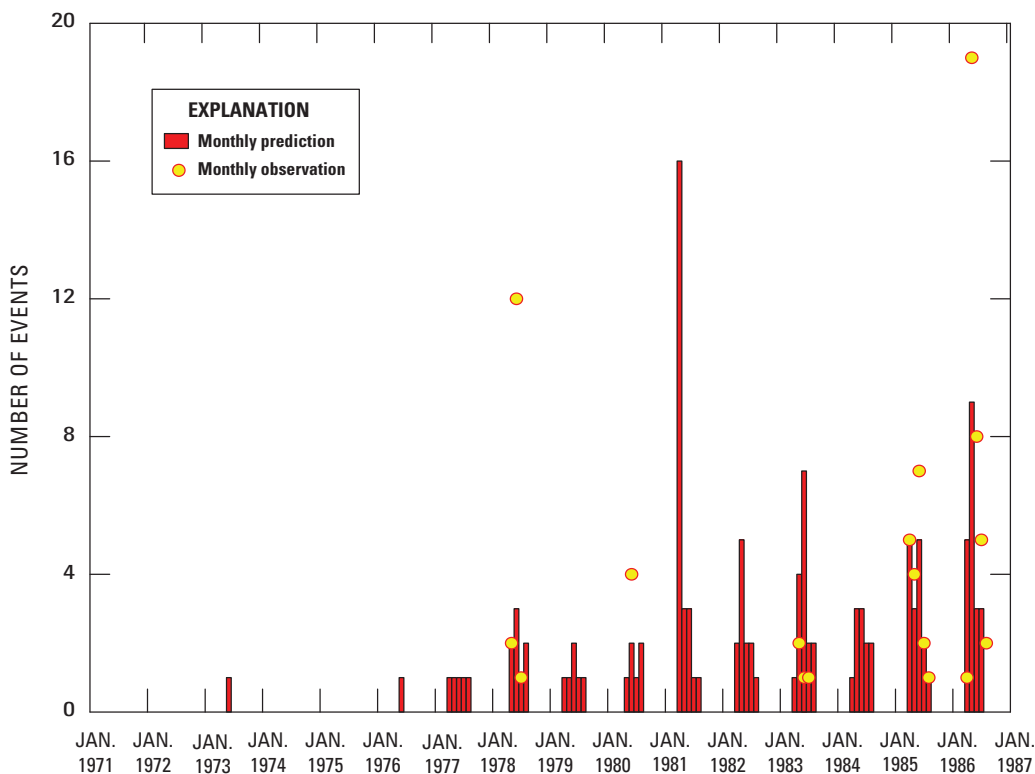

Figure S8.4.8. Comparison of monthly predicted number of transfer events with the observations for the case excluding September, Hadnot Point–Holcomb Boulevard study area, U.S. Marine Corps Base Camp Lejeune, North Carolina, 1972–1986.

Conclusions

In this study, a methodology was developed and applied to predict the historical monthly water-transfer events through booster pump 742 connecting the Holcomb Boulevard and Hadnot Point water-distribution systems. This information is required by the Agency for Toxic Substances and Disease Registry to be used in water-distribution network modeling and contamination fate and transport simulations for the historical reconstruction of contaminant levels in the drinking water supplied by the two water treatment plants to family housing units at U.S. Marine Corps Base Camp Lejeune, North Carolina. The methodology described herein was developed to utilize the available data with maximum efficiency and effectiveness to estimate the monthly number of water-transfer events at the booster pump. This estimation is based on a probabilistic approach utilizing Markov Chain simulations. The fundamental step in the Markov Chain model is to determine the probabilities of operational transitions for booster pump 742, as described in the Methodology section. In this study, the transition probabilities were determined by using the available data to obtain the conditional probabilities of a water-transfer event, given that a parameter or a pair of parameters is known. The known parameters in the available data are minimum and maximum temperatures, precipitation, and the delivered finished-water volume by the Holcomb Boulevard water treatment plant. Among these parameters, the best predictions are obtained when using the joint probability of precipitation and delivered finished-water volume. In this study, the joint probability density functions were obtained by using the Copula concept. Once the transition probabilities were estimated, a large number of Markov Chain simulations were performed. Then, the average number of booster pump opening events for each year predicted in these Markov Chain simulations was calculated. Afterwards, these yearly predictions were distributed to the dry months of every year in a probabilistic way. The results indicate that the predictions of the methodology are reasonable when compared to observations; therefore, this approach is effective in estimating the number of water transfers from the Hadnot Point water-distribution system to the Holcomb Boulevard water-distribution system.

References

- Ahmed MA, Alkhamis TM, and Miller DR. Time-Inhomogeneous Discrete Stochastic Search Methods for Optimal Bernoulli Parameters. *Applied Stochastic Models and Data Analysis*. 1998;14(3):199–217.
- Avery PJ and Henderson DA. Fitting Markov Chain Models to Discrete State Series Such as DNA Sequences. *Journal of the Royal Statistical Society Series C-Applied Statistics*. 1999;48: 53–61.
- Balster H. Markov Chain Models for Vegetation Dynamics. *Ecological Modelling*. 2000;126(2–3):139–154.
- CLW, Camp Lejeune Water Documents, 0001–8761 (not consecutively available), provided on CD-ROM format. In: Maslia ML, Sautner JB, Faye RE, Suárez-Soto RJ, Aral MM, Grayman WM, Jang W, Wang J, Bove FJ, Ruckart PZ, Valenzuela C, Green JW Jr, and Krueger AL. *Analyses of Groundwater Flow, Contaminant Fate and Transport, and Distribution of Drinking Water at Tarawa Terrace and Vicinity, U.S. Marine Corps Base Camp Lejeune, North Carolina: Historical Reconstruction and Present-Day Conditions—Chapter A: Summary of Findings*. Atlanta, GA: Agency for Toxic Substances and Disease Registry; 2007.
- Dai J, Tyler JE, and Mackenzie IG. Application of Markov Chains to Speech Recognition. *Electronics Letters*. 1991;27(25):2360–2361.
- De Michele C, Salvadori G, Canossi M, Petaccia A, and Rosso R. Bivariate Statistical Approach to Check Adequacy of Dam Spillway. *Journal of Hydrologic Engineering*. 2005;10(1): 50–57.
- Degweker SB. The Markov Chain Method for Solving Dead Time Problems in the Space Dependent Model of Reactor Noise. *Annals of Nuclear Energy*. 1997;24(16):1301–1319.
- Elliott RJ, Hunter WC, and Jamieson BM. Drift and Volatility Estimation in Discrete Time. *Journal of Economic Dynamics and Control*. 1998;22(2):209–218.

- Gani J and Stals L. The Spread of a Viral Infection in a Plantation. *Environmetrics*. 2004;15(6):555–560.
- Krieger UR, Muller-Clostermann B, and Sczittnick M. Modeling and Analysis of Communication Systems Based on Computational Methods for Markov Chains. *IEEE Journal on Selected Areas in Communications*. 1990;8(9):1630–1648.
- Logofet DO and Lesnaya EV. The Mathematics of Markov Models: What Markov Chains Can Really Predict in Forest Successions. *Ecological Modelling*. 2000;126(2–3):285–298.
- Maslia ML, Sautner JB, Faye RE, Suárez-Soto RJ, Aral MM, Grayman WM, Jang W, Wang J, Bove FJ, Ruckart PZ, Valenzuela C, Green JW Jr, and Krueger AL. Analyses of Groundwater Flow, Contaminant Fate and Transport, and Distribution of Drinking Water at Tarawa Terrace and Vicinity, U.S. Marine Corps Base Camp Lejeune, North Carolina: Historical Reconstruction and Present-Day Conditions—Chapter A: Summary of Findings. Atlanta, GA: Agency for Toxic Substances and Disease Registry; 2007a.
- Maslia ML, Sautner JB, et al. Analyses of Groundwater Flow, Contaminant Fate and Transport, and Distribution of Drinking Water at Tarawa Terrace and Vicinity, U.S. Marine Corps Base Camp Lejeune, North Carolina: Historical Reconstruction and Present-Day Conditions—Chapter K: Supplemental Information. Atlanta, GA: Agency for Toxic Substances and Disease Registry; 2007b.
- Maslia ML, Suárez-Soto RJ, Wang J, Aral MM, Faye RE, Sautner JB, Valenzuela C, Grayman WM. Analyses of Groundwater Flow, Contaminant Fate and Transport, and Distribution of Drinking Water at Tarawa Terrace and Vicinity, U.S. Marine Corps Base Camp Lejeune, North Carolina: Historical Reconstruction and Present-Day Conditions—Chapter I: Parameter Sensitivity, Uncertainty, and Variability Associated with Model Simulations of Groundwater Flow, Contaminant Fate and Transport, and Distribution of Drinking Water. Atlanta, GA: Agency for Toxic Substances and Disease Registry; 2009.
- MATLAB®, version R2012b (computer software), The MathWorks Inc., Natick, MA: 2012.
- McDonnell J, Goverde AJ, Rutten FFH, and Vermeiden JPW. Multivariate Markov Chain Analysis of the Probability of Pregnancy in Infertile Couples Undergoing Assisted Reproduction. *Human Reproduction*. 2002;17(1):103–106.
- Norberg T, Rosen L, Baran Á, and Baran S. On Modelling Discrete Geological Structures as Markov Random Fields. *Mathematical Geology*. 2002;34(1):63–77.
- Ranta J, Mäkelä PH, and Arjas E. Predicting Meningococcal Disease Outbreaks in Structured Populations. *Statistics in Medicine*. 2004;23(6):927–945.
- Ross SM. *Introduction to Probability Models*. London, UK: Academic Press; 1997.
- Sano A, Shimizu A, and Iizuka M. Coalescent Process with Fluctuating Population Size and Its Effective Size. *Theoretical Population Biology*. 2004;65(1):39–48.
- Setti G, Mazzini G, Rovatti R, and Callegari S. Statistical Modeling of Discrete-Time Chaotic Processes—Basic Finite-Dimensional Tools and Applications. *Proceedings of the IEEE*. 2002;90(5):662–690.
- Shiau JT. Fitting Drought Duration and Severity with Two-Dimensional Copulas. *Water Resources Management*. 2006;20(5):795–815.
- Singh VP and Zhang L. Stochastic Air Quality Analysis. In: Aral MM, Brebbia CA, Maslia ML, and Sinks T. *Environmental Exposure and Health*. Southampton, UK: WIT Press; 2005:3–12.
- Wang J and Aral MM. Analyses of Groundwater Flow, Contaminant Fate and Transport, and Distribution of Drinking Water at Tarawa Terrace and Vicinity, U.S. Marine Corps Base Camp Lejeune, North Carolina: Historical Reconstruction and Present-Day Conditions—Chapter H: Effect of Groundwater Pumping Schedule Variation on Arrival of Tetrachloroethylene (PCE) at Water-Supply Wells and Water Treatment Plant. Atlanta, GA: Agency for Toxic Substances and Disease Registry; 2008.
- Zhang L and Singh VP. Bivariate Flood Frequency Analysis Using the Copula Method. *Journal of Hydrologic Engineering*. 2006;11(2):150–164.

Appendix S8.5. Reconstructed (Simulated) Mean Concentrations of Tetrachloroethylene (PCE), Trichloroethylene (TCE), *trans*-1,2-Dichloroethylene (1,2-tDCE), Vinyl Chloride (VC), and Benzene in Finished Water Distributed to Holcomb Boulevard Family Housing Areas, Hadnot Point–Holcomb Boulevard Study Area, U.S. Marine Corps Base Camp Lejeune, North Carolina, 1972–1985

Table S8.5.1. Reconstructed (simulated) mean tetrachloroethylene (PCE) concentrations of finished water distributed to Holcomb Boulevard family housing areas for interconnection events, Hadnot Point–Holcomb Boulevard study area, U.S. Marine Corps Base Camp Lejeune, North Carolina, 1972–1985.¹

[PP, Paradise Point; MP, Midway Park; BM, Berkeley Manor; WV, Watkins Village; —, not applicable; concentration in micrograms per liter (µg/L)]

| Month | 1972 ² | | | | 1973 | | | | 1974 | | | | 1975 | | | | 1976 | | | |
|-------|-------------------|----|----|-----------------|------|----|----|-----------------|------|----|----|-----------------|-------------------|----|----|-----------------|------|----|----|-----------------|
| | PP | MP | BM | WV ³ | PP | MP | BM | WV ³ | PP | MP | BM | WV ³ | PP | MP | BM | WV ³ | PP | MP | BM | WV ³ |
| Jan | 0 | 0 | 0 | — | 0 | 0 | 0 | — | 0 | 0 | 0 | — | 0 | 0 | 0 | — | 0 | 0 | 0 | — |
| Feb | 0 | 0 | 0 | — | 0 | 0 | 0 | — | 0 | 0 | 0 | — | 0 | 0 | 0 | — | 0 | 0 | 0 | — |
| Mar | 0 | 0 | 0 | — | 0 | 0 | 0 | — | 0 | 0 | 0 | — | 0 | 0 | 0 | — | 0 | 0 | 0 | — |
| Apr | 0 | 0 | 0 | — | 0 | 0 | 0 | — | 0 | 0 | 0 | — | 0 | 0 | 0 | — | 0 | 0 | 0 | — |
| May | 0 | 0 | 0 | — | 0 | 0 | 0 | — | 0 | 0 | 0 | — | 0 | 0 | 0 | — | 0 | 0 | 0 | — |
| Jun | 0 | 0 | 0 | — | 0 | 0 | 0 | — | 0 | 0 | 0 | — | 0 | 0 | 0 | — | 0 | 0 | 0 | — |
| Jul | 0 | 0 | 0 | — | 0 | 0 | 0 | — | 0 | 0 | 0 | — | 0 | 0 | 0 | — | 0 | 0 | 0 | — |
| Aug | 0 | 0 | 0 | — | 0 | 0 | 0 | — | 0 | 0 | 0 | — | 0 | 0 | 0 | — | 0 | 0 | 0 | — |
| Sep | 0 | 0 | 0 | — | 0 | 0 | 0 | — | 0 | 0 | 0 | — | 0 | 0 | 0 | — | 0 | 0 | 0 | — |
| Oct | 0 | 0 | 0 | — | 0 | 0 | 0 | — | 0 | 0 | 0 | — | 0 | 0 | 0 | — | 0 | 0 | 0 | — |
| Nov | 0 | 0 | 0 | — | 0 | 0 | 0 | — | 0 | 0 | 0 | — | 0 | 0 | 0 | — | 0 | 0 | 0 | — |
| Dec | 0 | 0 | 0 | — | 0 | 0 | 0 | — | 0 | 0 | 0 | — | 0 | 0 | 0 | — | 0 | 0 | 0 | — |
| Month | 1977 | | | | 1978 | | | | 1979 | | | | 1980 | | | | 1981 | | | |
| | PP | MP | BM | WV ³ | PP | MP | BM | WV ³ | PP | MP | BM | WV | PP | MP | BM | WV | PP | MP | BM | WV |
| Jan | 0 | 0 | 0 | — | 0 | 0 | 0 | 0 | 0 | 0 | 0 | 0 | 0 | 0 | 0 | 0 | 0 | 0 | 0 | 0 |
| Feb | 0 | 0 | 0 | — | 0 | 0 | 0 | 0 | 0 | 0 | 0 | 0 | 0 | 0 | 0 | 0 | 0 | 0 | 0 | 0 |
| Mar | 0 | 0 | 0 | — | 0 | 0 | 0 | 0 | 0 | 0 | 0 | 0 | 0 | 0 | 0 | 0 | 0 | 0 | 0 | 0 |
| Apr | 0 | 0 | 0 | — | 0 | 0 | 0 | 0 | 0 | 0 | 0 | 0 | 0 | 0 | 0 | 0 | 0 | 0 | 2 | 1 |
| May | 0 | 0 | 0 | — | 0 | 0 | 0 | 0 | 0 | 0 | 0 | 0 | 0 | 0 | 0 | 0 | 0 | 0 | 1 | 0 |
| Jun | 0 | 0 | 0 | — | 0 | 1 | 2 | 2 | 0 | 0 | 0 | 0 | 0 | 0 | 1 | 1 | 0 | 0 | 0 | 0 |
| Jul | 0 | 0 | 0 | — | 0 | 0 | 0 | 0 | 0 | 0 | 0 | 0 | 0 | 0 | 0 | 0 | 0 | 0 | 0 | 0 |
| Aug | 0 | 0 | 0 | — | 0 | 0 | 0 | 0 | 0 | 0 | 0 | 0 | 0 | 0 | 0 | 0 | 0 | 0 | 0 | 0 |
| Sep | 0 | 0 | 0 | — | 0 | 0 | 0 | 0 | 0 | 0 | 0 | 0 | 0 | 0 | 0 | 0 | 0 | 0 | 0 | 0 |
| Oct | 0 | 0 | 0 | — | 0 | 0 | 0 | 0 | 0 | 0 | 0 | 0 | 0 | 0 | 0 | 0 | 0 | 0 | 0 | 0 |
| Nov | 0 | 0 | 0 | — | 0 | 0 | 0 | 0 | 0 | 0 | 0 | 0 | 0 | 0 | 0 | 0 | 0 | 0 | 0 | 0 |
| Dec | 0 | 0 | 0 | — | 0 | 0 | 0 | 0 | 0 | 0 | 0 | 0 | 0 | 0 | 0 | 0 | 0 | 0 | 0 | 0 |
| Month | 1982 | | | | 1983 | | | | 1984 | | | | 1985 ⁴ | | | | 1986 | | | |
| | PP | MP | BM | WV | PP | MP | BM | WV | PP | MP | BM | WV | PP | MP | BM | WV | PP | MP | BM | WV |
| Jan | 0 | 0 | 0 | 0 | 0 | 0 | 0 | 0 | 0 | 0 | 0 | 0 | 2 | 2 | 2 | 2 | | | | |
| Feb | 0 | 0 | 0 | 0 | 0 | 0 | 0 | 0 | 0 | 0 | 0 | 0 | 3 | 3 | 3 | 3 | | | | |
| Mar | 0 | 0 | 0 | 0 | 0 | 0 | 0 | 0 | 0 | 0 | 0 | 0 | 0 | 0 | 0 | 0 | | | | |
| Apr | 0 | 0 | 0 | 0 | 0 | 0 | 0 | 0 | 0 | 0 | 0 | 0 | 0 | 0 | 0 | 0 | | | | |
| May | 0 | 0 | 1 | 1 | 0 | 0 | 1 | 0 | 0 | 0 | 0 | 0 | 0 | 0 | 0 | 0 | | | | |
| Jun | 0 | 0 | 1 | 0 | 0 | 0 | 0 | 0 | 0 | 0 | 0 | 0 | 0 | 0 | 0 | 0 | | | | |
| Jul | 0 | 0 | 1 | 0 | 0 | 0 | 0 | 0 | 0 | 0 | 0 | 0 | 0 | 0 | 0 | 0 | | | | |
| Aug | 0 | 0 | 0 | 0 | 0 | 0 | 0 | 0 | 0 | 0 | 0 | 0 | 0 | 0 | 0 | 0 | | | | |
| Sep | 0 | 0 | 0 | 0 | 0 | 0 | 0 | 0 | 0 | 0 | 0 | 0 | 0 | 0 | 0 | 0 | | | | |
| Oct | 0 | 0 | 0 | 0 | 0 | 0 | 0 | 0 | 0 | 0 | 0 | 0 | 0 | 0 | 0 | 0 | | | | |
| Nov | 0 | 0 | 0 | 0 | 0 | 0 | 0 | 0 | 0 | 0 | 0 | 0 | 0 | 0 | 0 | 0 | | | | |
| Dec | 0 | 0 | 0 | 0 | 0 | 0 | 0 | 0 | 0 | 0 | 0 | 0 | 0 | 0 | 0 | 0 | | | | |

¹Derived from multiplying mean monthly concentrations of finished water from the Hadnot Point water treatment plant (Appendix A6) by average percent (unrounded) of Hadnot Point of water distributed through booster pump 742 (Table A14); current maximum contaminant level (MCL) for PCE is 5 µg/L.

²Prior to June 1972 when Holcomb Boulevard water treatment plant came on line, 100% of Hadnot Point water was delivered to Holcomb Boulevard family housing areas (also see Appendix A6 for January–May 1972).

³Watkins Village housing was not built and occupied until about 1978 (Faye et al. 2010) and the first documented interconnection occurs during May 1978 (Camp Lejeune Water Documents CLW #7023, 7031, and 7033).

⁴For period of January 28–February 4, 1985, booster pump 742 operated continuously due to shut down of Holcomb Boulevard WTP; this continuous event is not included in the Markov Chain analysis.

Table S8.5.2. Reconstructed (simulated) mean trichloroethylene (TCE) concentrations of finished water distributed to Holcomb Boulevard family housing areas for interconnection events, Hadnot Point–Holcomb Boulevard study area, U.S. Marine Corps Base Camp Lejeune, North Carolina, 1972–1985.¹

[PP, Paradise Point; MP, Midway Park; BM, Berkeley Manor; WV, Watkins Village; —, not applicable; concentration in micrograms per liter (µg/L)]

| Month | 1972 ² | | | | 1973 | | | | 1974 | | | | 1975 | | | | 1976 | | | |
|-------|-------------------|----|----|-----------------|------|----|----|-----------------|------|----|----|-----------------|-------------------|----|----|-----------------|------|----|----|-----------------|
| | PP | MP | BM | WV ³ | PP | MP | BM | WV ³ | PP | MP | BM | WV ³ | PP | MP | BM | WV ³ | PP | MP | BM | WV ³ |
| Jan | 22 | 22 | 22 | — | 0 | 0 | 0 | — | 0 | 0 | 0 | — | 0 | 0 | 0 | — | 0 | 0 | 0 | — |
| Feb | 21 | 21 | 21 | — | 0 | 0 | 0 | — | 0 | 0 | 0 | — | 0 | 0 | 0 | — | 0 | 0 | 0 | — |
| Mar | 17 | 17 | 17 | — | 0 | 0 | 0 | — | 0 | 0 | 0 | — | 0 | 0 | 0 | — | 0 | 0 | 0 | — |
| Apr | 24 | 24 | 24 | — | 0 | 0 | 0 | — | 0 | 0 | 0 | — | 0 | 0 | 0 | — | 0 | 0 | 0 | — |
| May | 19 | 19 | 19 | — | 0 | 0 | 0 | — | 0 | 0 | 0 | — | 0 | 0 | 0 | — | 0 | 0 | 0 | — |
| Jun | 19 | 19 | 19 | — | 0 | 0 | 1 | — | 0 | 0 | 0 | — | 0 | 0 | 0 | — | 1 | 2 | 3 | — |
| Jul | 1 | 0 | 0 | — | 0 | 0 | 0 | — | 0 | 0 | 0 | — | 0 | 0 | 0 | — | 0 | 0 | 0 | — |
| Aug | 0 | 0 | 0 | — | 0 | 0 | 0 | — | 0 | 0 | 0 | — | 0 | 0 | 0 | — | 0 | 0 | 0 | — |
| Sep | 0 | 0 | 0 | — | 0 | 0 | 0 | — | 0 | 0 | 0 | — | 0 | 0 | 0 | — | 0 | 0 | 0 | — |
| Oct | 0 | 0 | 0 | — | 0 | 0 | 0 | — | 0 | 0 | 0 | — | 0 | 0 | 0 | — | 0 | 0 | 0 | — |
| Nov | 0 | 0 | 0 | — | 0 | 0 | 0 | — | 0 | 0 | 0 | — | 0 | 0 | 0 | — | 0 | 0 | 0 | — |
| Dec | 0 | 0 | 0 | — | 0 | 0 | 0 | — | 0 | 0 | 0 | — | 0 | 0 | 0 | — | 0 | 0 | 0 | — |
| Month | 1977 | | | | 1978 | | | | 1979 | | | | 1980 | | | | 1981 | | | |
| | PP | MP | BM | WV ³ | PP | MP | BM | WV ³ | PP | MP | BM | WV | PP | MP | BM | WV | PP | MP | BM | WV |
| Jan | 0 | 0 | 0 | — | 0 | 0 | 0 | 0 | 0 | 0 | 0 | 0 | 0 | 0 | 0 | 0 | 0 | 0 | 0 | 0 |
| Feb | 0 | 0 | 0 | — | 0 | 0 | 0 | 0 | 0 | 0 | 0 | 0 | 0 | 0 | 0 | 0 | 0 | 0 | 0 | 0 |
| Mar | 0 | 0 | 0 | — | 0 | 0 | 0 | 0 | 0 | 0 | 0 | 0 | 0 | 0 | 0 | 0 | 0 | 0 | 0 | 0 |
| Apr | 0 | 1 | 2 | — | 0 | 0 | 0 | 0 | 0 | 1 | 2 | 1 | 0 | 0 | 0 | 0 | 0 | 4 | 39 | 28 |
| May | 1 | 1 | 3 | — | 0 | 2 | 6 | 4 | 0 | 1 | 3 | 2 | 0 | 0 | 0 | 0 | 0 | 4 | 13 | 10 |
| Jun | 1 | 2 | 3 | — | 3 | 23 | 51 | 38 | 0 | 2 | 6 | 4 | 2 | 8 | 17 | 13 | 0 | 4 | 10 | 7 |
| Jul | 1 | 2 | 3 | — | 0 | 0 | 1 | 1 | 0 | 1 | 4 | 2 | 0 | 0 | 0 | 0 | 0 | 2 | 4 | 3 |
| Aug | 1 | 2 | 4 | — | 0 | 0 | 0 | 0 | 0 | 2 | 5 | 3 | 0 | 0 | 0 | 0 | 0 | 2 | 6 | 4 |
| Sep | 0 | 0 | 0 | — | 0 | 0 | 0 | 0 | 0 | 0 | 0 | 0 | 0 | 0 | 0 | 0 | 0 | 0 | 0 | 0 |
| Oct | 0 | 0 | 0 | — | 0 | 0 | 0 | 0 | 0 | 0 | 0 | 0 | 0 | 0 | 0 | 0 | 0 | 0 | 0 | 0 |
| Nov | 0 | 0 | 0 | — | 0 | 0 | 0 | 0 | 0 | 0 | 0 | 0 | 0 | 0 | 0 | 0 | 0 | 0 | 0 | 0 |
| Dec | 0 | 0 | 0 | — | 0 | 0 | 0 | 0 | 0 | 0 | 0 | 0 | 0 | 0 | 0 | 0 | 0 | 0 | 0 | 0 |
| Month | 1982 | | | | 1983 | | | | 1984 | | | | 1985 ⁴ | | | | 1986 | | | |
| | PP | MP | BM | WV | PP | MP | BM | WV | PP | MP | BM | WV | PP | MP | BM | WV | PP | MP | BM | WV |
| Jan | 0 | 0 | 0 | 0 | 0 | 0 | 0 | 0 | 0 | 0 | 0 | 0 | 34 | 31 | 32 | 34 | | | | |
| Feb | 0 | 0 | 0 | 0 | 0 | 0 | 0 | 0 | 0 | 0 | 0 | 0 | 66 | 53 | 54 | 56 | | | | |
| Mar | 0 | 0 | 0 | 0 | 0 | 0 | 0 | 0 | 0 | 0 | 0 | 0 | 0 | 0 | 0 | 0 | | | | |
| Apr | 0 | 3 | 9 | 7 | 0 | 0 | 0 | 0 | 0 | 2 | 5 | 3 | 0 | 0 | 0 | 0 | | | | |
| May | 1 | 6 | 20 | 13 | 1 | 5 | 14 | 10 | 0 | 0 | 0 | 0 | 0 | 0 | 0 | 0 | | | | |
| Jun | 0 | 4 | 10 | 7 | 0 | 0 | 2 | 2 | 0 | 0 | 0 | 0 | 0 | 0 | 0 | 0 | | | | |
| Jul | 0 | 4 | 12 | 8 | 0 | 0 | 3 | 2 | 0 | 0 | 0 | 0 | 0 | 0 | 0 | 0 | | | | |
| Aug | 1 | 3 | 6 | 4 | 0 | 2 | 5 | 3 | 0 | 0 | 0 | 0 | 0 | 0 | 0 | 0 | | | | |
| Sep | 0 | 0 | 0 | 0 | 0 | 0 | 0 | 0 | 0 | 0 | 0 | 0 | 0 | 0 | 0 | 0 | | | | |
| Oct | 0 | 0 | 0 | 0 | 0 | 0 | 0 | 0 | 0 | 0 | 0 | 0 | 0 | 0 | 0 | 0 | | | | |
| Nov | 0 | 0 | 0 | 0 | 0 | 0 | 0 | 0 | 0 | 0 | 0 | 0 | 0 | 0 | 0 | 0 | | | | |
| Dec | 0 | 0 | 0 | 0 | 0 | 0 | 0 | 0 | 0 | 0 | 0 | 0 | 0 | 0 | 0 | 0 | | | | |

¹Derived from multiplying mean monthly concentrations of finished water from the Hadnot Point water treatment plant (Appendix A6) by average percent (unrounded) of Hadnot Point of water distributed through booster pump 742 (Table A14); current maximum contaminant level (MCL) for TCE is 5 µg/L.

²Prior to June 1972 when Holcomb Boulevard water treatment plant came on line, 100% of Hadnot Point water was delivered to Holcomb Boulevard family housing areas (also see Appendix A6 for January–May 1972).

³Watkins Village housing was not built and occupied until about 1978 (Faye et al. 2010) and the first documented interconnection occurs during May 1978 (Camp Lejeune Water Documents CLW #7023, 7031, and 7033).

⁴For period of January 28–February 4, 1985, booster pump 742 operated continuously due to shut down of Holcomb Boulevard WTP; this continuous event is not included in the Markov Chain analysis.

Table S8.5.3. Reconstructed (simulated) mean trans-1,2-dichloroethylene (1,2-tDCE) concentrations of finished water distributed to Holcomb Boulevard family housing areas for interconnection events, Hadnot Point–Holcomb Boulevard study area, U.S. Marine Corps Base Camp Lejeune, North Carolina, 1972–1985.¹

[PP, Paradise Point; MP, Midway Park; BM, Berkeley Manor; WV, Watkins Village; —, not applicable; concentration in micrograms per liter (µg/L)]

| Month | 1972 ² | | | | 1973 | | | | 1974 | | | | 1975 | | | | 1976 | | | |
|-------|-------------------|----|----|-----------------|------|----|----|-----------------|------|----|----|-----------------|-------------------|----|----|-----------------|------|----|----|-----------------|
| | PP | MP | BM | WV ³ | PP | MP | BM | WV ³ | PP | MP | BM | WV ³ | PP | MP | BM | WV ³ | PP | MP | BM | WV ³ |
| Jan | 0 | 0 | 0 | — | 0 | 0 | 0 | — | 0 | 0 | 0 | — | 0 | 0 | 0 | — | 0 | 0 | 0 | — |
| Feb | 0 | 0 | 0 | — | 0 | 0 | 0 | — | 0 | 0 | 0 | — | 0 | 0 | 0 | — | 0 | 0 | 0 | — |
| Mar | 0 | 0 | 0 | — | 0 | 0 | 0 | — | 0 | 0 | 0 | — | 0 | 0 | 0 | — | 0 | 0 | 0 | — |
| Apr | 0 | 0 | 0 | — | 0 | 0 | 0 | — | 0 | 0 | 0 | — | 0 | 0 | 0 | — | 0 | 0 | 0 | — |
| May | 0 | 0 | 0 | — | 0 | 0 | 0 | — | 0 | 0 | 0 | — | 0 | 0 | 0 | — | 0 | 0 | 0 | — |
| Jun | 0 | 0 | 0 | — | 0 | 1 | 1 | — | 0 | 0 | 0 | — | 0 | 0 | 0 | — | 0 | 1 | 2 | — |
| Jul | 0 | 0 | 0 | — | 0 | 0 | 0 | — | 0 | 0 | 0 | — | 0 | 0 | 0 | — | 0 | 0 | 0 | — |
| Aug | 0 | 0 | 0 | — | 0 | 0 | 0 | — | 0 | 0 | 0 | — | 0 | 0 | 0 | — | 0 | 0 | 0 | — |
| Sep | 0 | 0 | 0 | — | 0 | 0 | 0 | — | 0 | 0 | 0 | — | 0 | 0 | 0 | — | 0 | 0 | 0 | — |
| Oct | 0 | 0 | 0 | — | 0 | 0 | 0 | — | 0 | 0 | 0 | — | 0 | 0 | 0 | — | 0 | 0 | 0 | — |
| Nov | 0 | 0 | 0 | — | 0 | 0 | 0 | — | 0 | 0 | 0 | — | 0 | 0 | 0 | — | 0 | 0 | 0 | — |
| Dec | 0 | 0 | 0 | — | 0 | 0 | 0 | — | 0 | 0 | 0 | — | 0 | 0 | 0 | — | 0 | 0 | 0 | — |
| Month | 1977 | | | | 1978 | | | | 1979 | | | | 1980 | | | | 1981 | | | |
| | PP | MP | BM | WV ³ | PP | MP | BM | WV ³ | PP | MP | BM | WV | PP | MP | BM | WV | PP | MP | BM | WV |
| Jan | 0 | 0 | 0 | — | 0 | 0 | 0 | 0 | 0 | 0 | 0 | 0 | 0 | 0 | 0 | 0 | 0 | 0 | 0 | 0 |
| Feb | 0 | 0 | 0 | — | 0 | 0 | 0 | 0 | 0 | 0 | 0 | 0 | 0 | 0 | 0 | 0 | 0 | 0 | 0 | 0 |
| Mar | 0 | 0 | 0 | — | 0 | 0 | 0 | 0 | 0 | 0 | 0 | 0 | 0 | 0 | 0 | 0 | 0 | 0 | 0 | 0 |
| Apr | 0 | 1 | 1 | — | 0 | 0 | 0 | 0 | 0 | 1 | 1 | 1 | 0 | 0 | 0 | 0 | 0 | 2 | 16 | 12 |
| May | 0 | 1 | 1 | — | 0 | 1 | 3 | 2 | 0 | 0 | 1 | 1 | 0 | 0 | 0 | 0 | 0 | 2 | 6 | 4 |
| Jun | 0 | 1 | 1 | — | 2 | 10 | 22 | 17 | 0 | 1 | 3 | 2 | 1 | 3 | 7 | 5 | 0 | 2 | 4 | 3 |
| Jul | 0 | 1 | 2 | — | 0 | 0 | 0 | 0 | 0 | 0 | 1 | 1 | 0 | 0 | 0 | 0 | 0 | 1 | 2 | 1 |
| Aug | 0 | 1 | 2 | — | 0 | 0 | 0 | 0 | 0 | 1 | 2 | 1 | 0 | 0 | 0 | 0 | 0 | 1 | 3 | 2 |
| Sep | 0 | 0 | 0 | — | 0 | 0 | 0 | 0 | 0 | 0 | 0 | 0 | 0 | 0 | 0 | 0 | 0 | 0 | 0 | 0 |
| Oct | 0 | 0 | 0 | — | 0 | 0 | 0 | 0 | 0 | 0 | 0 | 0 | 0 | 0 | 0 | 0 | 0 | 0 | 0 | 0 |
| Nov | 0 | 0 | 0 | — | 0 | 0 | 0 | 0 | 0 | 0 | 0 | 0 | 0 | 0 | 0 | 0 | 0 | 0 | 0 | 0 |
| Dec | 0 | 0 | 0 | — | 0 | 0 | 0 | 0 | 0 | 0 | 0 | 0 | 0 | 0 | 0 | 0 | 0 | 0 | 0 | 0 |
| Month | 1982 | | | | 1983 | | | | 1984 | | | | 1985 ⁴ | | | | 1986 | | | |
| | PP | MP | BM | WV | PP | MP | BM | WV | PP | MP | BM | WV | PP | MP | BM | WV | PP | MP | BM | WV |
| Jan | 0 | 0 | 0 | 0 | 0 | 0 | 0 | 0 | 0 | 0 | 0 | 0 | 17 | 16 | 16 | 17 | | | | |
| Feb | 0 | 0 | 0 | 0 | 0 | 0 | 0 | 0 | 0 | 0 | 0 | 0 | 33 | 27 | 27 | 28 | | | | |
| Mar | 0 | 0 | 0 | 0 | 0 | 0 | 0 | 0 | 0 | 0 | 0 | 0 | 0 | 0 | 0 | 0 | | | | |
| Apr | 0 | 2 | 4 | 3 | 0 | 0 | 0 | 0 | 0 | 1 | 2 | 2 | 0 | 0 | 0 | 0 | | | | |
| May | 0 | 3 | 10 | 7 | 0 | 3 | 8 | 5 | 0 | 0 | 0 | 0 | 0 | 0 | 0 | 0 | | | | |
| Jun | 0 | 2 | 6 | 4 | 0 | 0 | 1 | 1 | 0 | 0 | 0 | 0 | 0 | 0 | 0 | 0 | | | | |
| Jul | 0 | 2 | 6 | 4 | 0 | 0 | 2 | 1 | 0 | 0 | 0 | 0 | 0 | 0 | 0 | 0 | | | | |
| Aug | 0 | 2 | 3 | 2 | 0 | 1 | 3 | 2 | 0 | 0 | 0 | 0 | 0 | 0 | 0 | 0 | | | | |
| Sep | 0 | 0 | 0 | 0 | 0 | 0 | 0 | 0 | 0 | 0 | 0 | 0 | 0 | 0 | 0 | 0 | | | | |
| Oct | 0 | 0 | 0 | 0 | 0 | 0 | 0 | 0 | 0 | 0 | 0 | 0 | 0 | 0 | 0 | 0 | | | | |
| Nov | 0 | 0 | 0 | 0 | 0 | 0 | 0 | 0 | 0 | 0 | 0 | 0 | 0 | 0 | 0 | 0 | | | | |
| Dec | 0 | 0 | 0 | 0 | 0 | 0 | 0 | 0 | 0 | 0 | 0 | 0 | 0 | 0 | 0 | 0 | | | | |

¹Derived from multiplying mean monthly concentrations of finished water from the Hadnot Point water treatment plant (Appendix A6) by average percent (unrounded) of Hadnot Point of water distributed through booster pump 742 (Table A14); current maximum contaminant level (MCL) for 1,2-tDCE is 100 µg/L.

²Prior to June 1972 when Holcomb Boulevard water treatment plant came on line, 100% of Hadnot Point water was delivered to Holcomb Boulevard family housing areas (also see Appendix A6 for January–May 1972).

³Watkins Village housing was not built and occupied until about 1978 (Faye et al. 2010) and the first documented interconnection occurs during May 1978 (Camp Lejeune Water Documents CLW #7023, 7031, and 7033).

⁴For period of January 28–February 4, 1985, booster pump 742 operated continuously due to shut down of Holcomb Boulevard WTP; this continuous event is not included in the Markov Chain analysis.

Table S8.5.4. Reconstructed (simulated) mean vinyl chloride (VC) concentrations of finished water distributed to Holcomb Boulevard family housing areas for interconnection events, Hadnot Point–Holcomb Boulevard study area, U.S. Marine Corps Base Camp Lejeune, North Carolina, 1972–1985.¹

[PP, Paradise Point; MP, Midway Park; BM, Berkeley Manor; WV, Watkins Village; —, not applicable; concentration in micrograms per liter (µg/L)]

| Month | 1972 ² | | | | 1973 | | | | 1974 | | | | 1975 | | | | 1976 | | | |
|-------|-------------------|----|----|-----------------|------|----|----|-----------------|------|----|----|-----------------|-------------------|----|----|-----------------|------|----|----|-----------------|
| | PP | MP | BM | WV ³ | PP | MP | BM | WV ³ | PP | MP | BM | WV ³ | PP | MP | BM | WV ³ | PP | MP | BM | WV ³ |
| Jan | 0 | 0 | 0 | — | 0 | 0 | 0 | — | 0 | 0 | 0 | — | 0 | 0 | 0 | — | 0 | 0 | 0 | — |
| Feb | 0 | 0 | 0 | — | 0 | 0 | 0 | — | 0 | 0 | 0 | — | 0 | 0 | 0 | — | 0 | 0 | 0 | — |
| Mar | 0 | 0 | 0 | — | 0 | 0 | 0 | — | 0 | 0 | 0 | — | 0 | 0 | 0 | — | 0 | 0 | 0 | — |
| Apr | 0 | 0 | 0 | — | 0 | 0 | 0 | — | 0 | 0 | 0 | — | 0 | 0 | 0 | — | 0 | 0 | 0 | — |
| May | 0 | 0 | 0 | — | 0 | 0 | 0 | — | 0 | 0 | 0 | — | 0 | 0 | 0 | — | 0 | 0 | 0 | — |
| Jun | 0 | 0 | 0 | — | 0 | 0 | 0 | — | 0 | 0 | 0 | — | 0 | 0 | 0 | — | 0 | 0 | 0 | — |
| Jul | 0 | 0 | 0 | — | 0 | 0 | 0 | — | 0 | 0 | 0 | — | 0 | 0 | 0 | — | 0 | 0 | 0 | — |
| Aug | 0 | 0 | 0 | — | 0 | 0 | 0 | — | 0 | 0 | 0 | — | 0 | 0 | 0 | — | 0 | 0 | 0 | — |
| Sep | 0 | 0 | 0 | — | 0 | 0 | 0 | — | 0 | 0 | 0 | — | 0 | 0 | 0 | — | 0 | 0 | 0 | — |
| Oct | 0 | 0 | 0 | — | 0 | 0 | 0 | — | 0 | 0 | 0 | — | 0 | 0 | 0 | — | 0 | 0 | 0 | — |
| Nov | 0 | 0 | 0 | — | 0 | 0 | 0 | — | 0 | 0 | 0 | — | 0 | 0 | 0 | — | 0 | 0 | 0 | — |
| Dec | 0 | 0 | 0 | — | 0 | 0 | 0 | — | 0 | 0 | 0 | — | 0 | 0 | 0 | — | 0 | 0 | 0 | — |
| Month | 1977 | | | | 1978 | | | | 1979 | | | | 1980 | | | | 1981 | | | |
| | PP | MP | BM | WV ³ | PP | MP | BM | WV ³ | PP | MP | BM | WV | PP | MP | BM | WV | PP | MP | BM | WV |
| Jan | 0 | 0 | 0 | — | 0 | 0 | 0 | 0 | 0 | 0 | 0 | 0 | 0 | 0 | 0 | 0 | 0 | 0 | 0 | 0 |
| Feb | 0 | 0 | 0 | — | 0 | 0 | 0 | 0 | 0 | 0 | 0 | 0 | 0 | 0 | 0 | 0 | 0 | 0 | 0 | 0 |
| Mar | 0 | 0 | 0 | — | 0 | 0 | 0 | 0 | 0 | 0 | 0 | 0 | 0 | 0 | 0 | 0 | 0 | 0 | 0 | 0 |
| Apr | 0 | 0 | 0 | — | 0 | 0 | 0 | 0 | 0 | 0 | 0 | 0 | 0 | 0 | 0 | 0 | 0 | 0 | 3 | 2 |
| May | 0 | 0 | 0 | — | 0 | 0 | 0 | 0 | 0 | 0 | 0 | 0 | 0 | 0 | 0 | 0 | 0 | 0 | 1 | 1 |
| Jun | 0 | 0 | 0 | — | 0 | 1 | 3 | 2 | 0 | 0 | 0 | 0 | 0 | 1 | 1 | 1 | 0 | 0 | 1 | 0 |
| Jul | 0 | 0 | 0 | — | 0 | 0 | 0 | 0 | 0 | 0 | 0 | 0 | 0 | 0 | 0 | 0 | 0 | 0 | 0 | 0 |
| Aug | 0 | 0 | 0 | — | 0 | 0 | 0 | 0 | 0 | 0 | 0 | 0 | 0 | 0 | 0 | 0 | 0 | 0 | 0 | 0 |
| Sep | 0 | 0 | 0 | — | 0 | 0 | 0 | 0 | 0 | 0 | 0 | 0 | 0 | 0 | 0 | 0 | 0 | 0 | 0 | 0 |
| Oct | 0 | 0 | 0 | — | 0 | 0 | 0 | 0 | 0 | 0 | 0 | 0 | 0 | 0 | 0 | 0 | 0 | 0 | 0 | 0 |
| Nov | 0 | 0 | 0 | — | 0 | 0 | 0 | 0 | 0 | 0 | 0 | 0 | 0 | 0 | 0 | 0 | 0 | 0 | 0 | 0 |
| Dec | 0 | 0 | 0 | — | 0 | 0 | 0 | 0 | 0 | 0 | 0 | 0 | 0 | 0 | 0 | 0 | 0 | 0 | 0 | 0 |
| Month | 1982 | | | | 1983 | | | | 1984 | | | | 1985 ⁴ | | | | 1986 | | | |
| | PP | MP | BM | WV | PP | MP | BM | WV | PP | MP | BM | WV | PP | MP | BM | WV | PP | MP | BM | WV |
| Jan | 0 | 0 | 0 | 0 | 0 | 0 | 0 | 0 | 0 | 0 | 0 | 0 | 3 | 3 | 3 | 3 | | | | |
| Feb | 0 | 0 | 0 | 0 | 0 | 0 | 0 | 0 | 0 | 0 | 0 | 0 | 6 | 5 | 5 | 5 | | | | |
| Mar | 0 | 0 | 0 | 0 | 0 | 0 | 0 | 0 | 0 | 0 | 0 | 0 | 0 | 0 | 0 | 0 | | | | |
| Apr | 0 | 0 | 1 | 0 | 0 | 0 | 0 | 0 | 0 | 0 | 0 | 0 | 0 | 0 | 0 | 0 | | | | |
| May | 0 | 0 | 1 | 1 | 0 | 0 | 1 | 1 | 0 | 0 | 0 | 0 | 0 | 0 | 0 | 0 | | | | |
| Jun | 0 | 0 | 1 | 1 | 0 | 0 | 0 | 0 | 0 | 0 | 0 | 0 | 0 | 0 | 0 | 0 | | | | |
| Jul | 0 | 0 | 1 | 1 | 0 | 0 | 0 | 0 | 0 | 0 | 0 | 0 | 0 | 0 | 0 | 0 | | | | |
| Aug | 0 | 0 | 0 | 0 | 0 | 0 | 0 | 0 | 0 | 0 | 0 | 0 | 0 | 0 | 0 | 0 | | | | |
| Sep | 0 | 0 | 0 | 0 | 0 | 0 | 0 | 0 | 0 | 0 | 0 | 0 | 0 | 0 | 0 | 0 | | | | |
| Oct | 0 | 0 | 0 | 0 | 0 | 0 | 0 | 0 | 0 | 0 | 0 | 0 | 0 | 0 | 0 | 0 | | | | |
| Nov | 0 | 0 | 0 | 0 | 0 | 0 | 0 | 0 | 0 | 0 | 0 | 0 | 0 | 0 | 0 | 0 | | | | |
| Dec | 0 | 0 | 0 | 0 | 0 | 0 | 0 | 0 | 0 | 0 | 0 | 0 | 0 | 0 | 0 | 0 | | | | |

¹Derived from multiplying mean monthly concentrations of finished water from the Hadnot Point water treatment plant (Appendix A6) by average percent (unrounded) of Hadnot Point of water distributed through booster pump 742 (Table A14); current maximum contaminant level (MCL) for VC is 2 µg/L.

²Prior to June 1972 when Holcomb Boulevard water treatment plant came on line, 100% of Hadnot Point water was delivered to Holcomb Boulevard family housing areas (also see Appendix A6 for January–May 1972).

³Watkins Village housing was not built and occupied until about 1978 (Faye et al. 2010) and the first documented interconnection occurs during May 1978 (Camp Lejeune Water Documents CLW #7023, 7031, and 7033).

⁴For period of January 28–February 4, 1985, booster pump 742 operated continuously due to shut down of Holcomb Boulevard WTP; this continuous event is not included in the Markov Chain analysis.

Table S8.5.5. Reconstructed (simulated) mean benzene concentrations of finished water distributed to Holcomb Boulevard family housing areas for interconnection events, Hadnot Point–Holcomb Boulevard study area, U.S. Marine Corps Base Camp Lejeune, North Carolina, 1972–1985.¹

[PP, Paradise Point; MP, Midway Park; BM, Berkeley Manor; WV, Watkins Village; —, not applicable; concentration in micrograms per liter (µg/L)]

| Month | 1972 ² | | | | 1973 | | | | 1974 | | | | 1975 | | | | 1976 | | | |
|-------|-------------------|----|----|-----------------|------|----|----|-----------------|------|----|----|-----------------|-------------------|----|----|-----------------|------|----|----|-----------------|
| | PP | MP | BM | WV ³ | PP | MP | BM | WV ³ | PP | MP | BM | WV ³ | PP | MP | BM | WV ³ | PP | MP | BM | WV ³ |
| Jan | 3 | 3 | 3 | — | 0 | 0 | 0 | — | 0 | 0 | 0 | — | 0 | 0 | 0 | — | 0 | 0 | 0 | — |
| Feb | 3 | 3 | 3 | — | 0 | 0 | 0 | — | 0 | 0 | 0 | — | 0 | 0 | 0 | — | 0 | 0 | 0 | — |
| Mar | 2 | 2 | 2 | — | 0 | 0 | 0 | — | 0 | 0 | 0 | — | 0 | 0 | 0 | — | 0 | 0 | 0 | — |
| Apr | 3 | 3 | 3 | — | 0 | 0 | 0 | — | 0 | 0 | 0 | — | 0 | 0 | 0 | — | 0 | 0 | 0 | — |
| May | 3 | 3 | 3 | — | 0 | 0 | 0 | — | 0 | 0 | 0 | — | 0 | 0 | 0 | — | 0 | 0 | 0 | — |
| Jun | 3 | 3 | 3 | — | 0 | 0 | 0 | — | 0 | 0 | 0 | — | 0 | 0 | 0 | — | 0 | 0 | 0 | — |
| Jul | 0 | 0 | 0 | — | 0 | 0 | 0 | — | 0 | 0 | 0 | — | 0 | 0 | 0 | — | 0 | 0 | 0 | — |
| Aug | 0 | 0 | 0 | — | 0 | 0 | 0 | — | 0 | 0 | 0 | — | 0 | 0 | 0 | — | 0 | 0 | 0 | — |
| Sep | 0 | 0 | 0 | — | 0 | 0 | 0 | — | 0 | 0 | 0 | — | 0 | 0 | 0 | — | 0 | 0 | 0 | — |
| Oct | 0 | 0 | 0 | — | 0 | 0 | 0 | — | 0 | 0 | 0 | — | 0 | 0 | 0 | — | 0 | 0 | 0 | — |
| Nov | 0 | 0 | 0 | — | 0 | 0 | 0 | — | 0 | 0 | 0 | — | 0 | 0 | 0 | — | 0 | 0 | 0 | — |
| Dec | 0 | 0 | 0 | — | 0 | 0 | 0 | — | 0 | 0 | 0 | — | 0 | 0 | 0 | — | 0 | 0 | 0 | — |
| Month | 1977 | | | | 1978 | | | | 1979 | | | | 1980 | | | | 1981 | | | |
| | PP | MP | BM | WV ³ | PP | MP | BM | WV ³ | PP | MP | BM | WV | PP | MP | BM | WV | PP | MP | BM | WV |
| Jan | 0 | 0 | 0 | — | 0 | 0 | 0 | 0 | 0 | 0 | 0 | 0 | 0 | 0 | 0 | 0 | 0 | 0 | 0 | 0 |
| Feb | 0 | 0 | 0 | — | 0 | 0 | 0 | 0 | 0 | 0 | 0 | 0 | 0 | 0 | 0 | 0 | 0 | 0 | 0 | 0 |
| Mar | 0 | 0 | 0 | — | 0 | 0 | 0 | 0 | 0 | 0 | 0 | 0 | 0 | 0 | 0 | 0 | 0 | 0 | 0 | 0 |
| Apr | 0 | 0 | 0 | — | 0 | 0 | 0 | 0 | 0 | 0 | 0 | 0 | 0 | 0 | 0 | 0 | 0 | 0 | 1 | 1 |
| May | 0 | 0 | 0 | — | 0 | 0 | 0 | 0 | 0 | 0 | 0 | 0 | 0 | 0 | 0 | 0 | 0 | 0 | 0 | 0 |
| Jun | 0 | 0 | 0 | — | 0 | 0 | 1 | 0 | 0 | 0 | 0 | 0 | 0 | 0 | 0 | 0 | 0 | 0 | 0 | 0 |
| Jul | 0 | 0 | 0 | — | 0 | 0 | 0 | 0 | 0 | 0 | 0 | 0 | 0 | 0 | 0 | 0 | 0 | 0 | 0 | 0 |
| Aug | 0 | 0 | 0 | — | 0 | 0 | 0 | 0 | 0 | 0 | 0 | 0 | 0 | 0 | 0 | 0 | 0 | 0 | 0 | 0 |
| Sep | 0 | 0 | 0 | — | 0 | 0 | 0 | 0 | 0 | 0 | 0 | 0 | 0 | 0 | 0 | 0 | 0 | 0 | 0 | 0 |
| Oct | 0 | 0 | 0 | — | 0 | 0 | 0 | 0 | 0 | 0 | 0 | 0 | 0 | 0 | 0 | 0 | 0 | 0 | 0 | 0 |
| Nov | 0 | 0 | 0 | — | 0 | 0 | 0 | 0 | 0 | 0 | 0 | 0 | 0 | 0 | 0 | 0 | 0 | 0 | 0 | 0 |
| Dec | 0 | 0 | 0 | — | 0 | 0 | 0 | 0 | 0 | 0 | 0 | 0 | 0 | 0 | 0 | 0 | 0 | 0 | 0 | 0 |
| Month | 1982 | | | | 1983 | | | | 1984 | | | | 1985 ⁴ | | | | 1986 | | | |
| | PP | MP | BM | WV | PP | MP | BM | WV | PP | MP | BM | WV | PP | MP | BM | WV | PP | MP | BM | WV |
| Jan | 0 | 0 | 0 | 0 | 0 | 0 | 0 | 0 | 0 | 0 | 0 | 0 | 0 | 0 | 0 | 0 | | | | |
| Feb | 0 | 0 | 0 | 0 | 0 | 0 | 0 | 0 | 0 | 0 | 0 | 0 | 1 | 1 | 1 | 1 | | | | |
| Mar | 0 | 0 | 0 | 0 | 0 | 0 | 0 | 0 | 0 | 0 | 0 | 0 | 0 | 0 | 0 | 0 | | | | |
| Apr | 0 | 0 | 0 | 0 | 0 | 0 | 0 | 0 | 0 | 0 | 0 | 0 | 0 | 0 | 0 | 0 | | | | |
| May | 0 | 0 | 0 | 0 | 0 | 0 | 0 | 0 | 0 | 0 | 0 | 0 | 0 | 0 | 0 | 0 | | | | |
| Jun | 0 | 0 | 0 | 0 | 0 | 0 | 0 | 0 | 0 | 0 | 0 | 0 | 0 | 0 | 0 | 0 | | | | |
| Jul | 0 | 0 | 0 | 0 | 0 | 0 | 0 | 0 | 0 | 0 | 0 | 0 | 0 | 0 | 0 | 0 | | | | |
| Aug | 0 | 0 | 0 | 0 | 0 | 0 | 0 | 0 | 0 | 0 | 0 | 0 | 0 | 0 | 0 | 0 | | | | |
| Sep | 0 | 0 | 0 | 0 | 0 | 0 | 0 | 0 | 0 | 0 | 0 | 0 | 0 | 0 | 0 | 0 | | | | |
| Oct | 0 | 0 | 0 | 0 | 0 | 0 | 0 | 0 | 0 | 0 | 0 | 0 | 0 | 0 | 0 | 0 | | | | |
| Nov | 0 | 0 | 0 | 0 | 0 | 0 | 0 | 0 | 0 | 0 | 0 | 0 | 0 | 0 | 0 | 0 | | | | |
| Dec | 0 | 0 | 0 | 0 | 0 | 0 | 0 | 0 | 0 | 0 | 0 | 0 | 0 | 0 | 0 | 0 | | | | |

¹Derived from multiplying mean monthly concentrations of finished water from the Hadnot Point water treatment plant (Appendix A6) by average percent (unrounded) of Hadnot Point of water distributed through booster pump 742 (Table A14); current maximum contaminant level (MCL) for benzene is 5 µg/L.²Prior to June 1972 when Holcomb Boulevard water treatment plant came on line, 100% of Hadnot Point water was delivered to Holcomb Boulevard family housing areas (also see Appendix A6 for January–May 1972).³Watkins Village housing was not built and occupied until about 1978 (Faye et al. 2010) and the first documented interconnection occurs during May 1978 (Camp Lejeune Water Documents CLW #7023, 7031, and 7033).⁴For period of January 28–February 4, 1985, booster pump 742 operated continuously due to shut down of Holcomb Boulevard WTP; this continuous event is not included in the Markov Chain analysis.

Appendix S8.6. Variations in Reconstructed (Simulated) Concentrations of Tetrachloroethylene (PCE), Trichloroethylene (TCE), *trans*-1,2-Dichloroethylene (1,2-tDCE), Vinyl Chloride (VC), and Benzene in Finished Water Distributed to Holcomb Boulevard Family Housing Areas, Hadnot Point–Holcomb Boulevard Study Area, U.S. Marine Corps Base Camp Lejeune, North Carolina, 1972–1985

Table S8.6.1. Reconstructed (simulated) Monte Carlo concentrations of tetrachloroethylene (PCE) in finished water distributed to Holcomb Boulevard family housing areas for selected months, Hadnot Point–Holcomb Boulevard study area, U.S. Marine Corps Base Camp Lejeune, North Carolina, 1972–1985.¹

[PP, Paradise Point; MP, Midway Park; BM, Berkeley Manor; WV, Watkins Village; —, not applicable]

| Month-Year | Calibrated PCE concentration, ² in micrograms per liter | | | | Range of PCE concentrations derived from Monte Carlo simulations, ³ in micrograms per liter | | | | | | | | | | | |
|-----------------------|---|----|----|-----------------|---|-----------------|-------------------|------------------|-----------------|-------------------|------------------|-----------------|-------------------|------------------------------|-----------------|-------------------|
| | | | | | Paradise Point | | | Midway Park | | | Berkeley Manor | | | Watkins Village ⁴ | | |
| | PP | MP | BM | WV ⁴ | P _{2.5} | P ₅₀ | P _{97.5} | P _{2.5} | P ₅₀ | P _{97.5} | P _{2.5} | P ₅₀ | P _{97.5} | P _{2.5} | P ₅₀ | P _{97.5} |
| Jun-1978 | 0 | 1 | 2 | 2 | 0 | 0 | 0 | 1 | 1 | 1 | 2 | 2 | 2 | 1 | 2 | 2 |
| Jun-1980 | 0 | 0 | 1 | 1 | 0 | 0 | 0 | 0 | 0 | 0 | 1 | 1 | 1 | 0 | 1 | 1 |
| Apr-1981 | 0 | 0 | 2 | 1 | 0 | 0 | 0 | 0 | 0 | 0 | 1 | 2 | 2 | 1 | 1 | 2 |
| May-1981 | 0 | 0 | 1 | 0 | 0 | 0 | 0 | 0 | 0 | 0 | 0 | 1 | 1 | 0 | 0 | 1 |
| May-1982 | 0 | 0 | 1 | 1 | 0 | 0 | 0 | 0 | 0 | 0 | 1 | 1 | 1 | 1 | 1 | 1 |
| Jun-1982 | 0 | 0 | 1 | 0 | 0 | 0 | 0 | 0 | 0 | 0 | 0 | 0 | 1 | 0 | 0 | 0 |
| Jul-1982 | 0 | 0 | 1 | 0 | 0 | 0 | 0 | 0 | 0 | 0 | 0 | 1 | 1 | 0 | 0 | 1 |
| May-1983 | 0 | 0 | 1 | 0 | 0 | 0 | 0 | 0 | 0 | 0 | 1 | 1 | 1 | 0 | 1 | 1 |
| Jan-1985 ⁵ | 2 | 2 | 2 | 2 | 2 | 2 | 2 | 2 | 2 | 2 | 2 | 2 | 2 | 2 | 2 | 2 |
| Feb-1985 ⁵ | 3 | 3 | 3 | 3 | 3 | 3 | 3 | 3 | 3 | 3 | 3 | 3 | 3 | 3 | 3 | 3 |

¹Current maximum contaminant level (MCL) for PCE is 5 micrograms per liter (µg/L); See Table A2a for description of PCE MCL value.²Calibrated concentration is determined from mean monthly concentration.³Monte Carlo simulated values generated using PEST (Doherty 2004, Doherty and Hunt 2010) consist of 1,000 realizations using normal distribution; P_{2.5}, 2.5 percentile; P₅₀, 50 percentile; P_{97.5}, 97.5 percentile.⁴Watkins Village housing was not built and occupied until about 1978 (Faye et al. 2010) and the first documented interconnection occurs during May 1978 (Camp Lejeune Water Documents CLW #7023, 7031, and 7033).⁵For the 8-day period January 28–February 4, 1985, the Holcomb Boulevard water treatment plant was shut down and contaminated Hadnot Point finished water was continuously provided to Holcomb Boulevard family housing areas.**Table S8.6.2.** Reconstructed (simulated) Monte Carlo concentrations of trichloroethylene (TCE) in finished water distributed to Holcomb Boulevard family housing areas for selected months, Hadnot Point–Holcomb Boulevard study area, U.S. Marine Corps Base Camp Lejeune, North Carolina, 1972–1985.^{1,*}

[PP, Paradise Point; MP, Midway Park; BM, Berkeley Manor; WV, Watkins Village; —, not applicable]

| Month-Year | Calibrated TCE concentration, ² in microgram per liter | | | | Range of TCE concentrations derived from Monte Carlo simulations ³ , in micrograms per liter | | | | | | | | | | | |
|------------|--|----|----|-----------------|---|-----------------|-------------------|------------------|-----------------|-------------------|------------------|-----------------|-------------------|------------------------------|-----------------|-------------------|
| | | | | | Paradise Point | | | Midway Park | | | Berkeley Manor | | | Watkins Village ⁴ | | |
| | PP | MP | BM | WV ⁴ | P _{2.5} | P ₅₀ | P _{97.5} | P _{2.5} | P ₅₀ | P _{97.5} | P _{2.5} | P ₅₀ | P _{97.5} | P _{2.5} | P ₅₀ | P _{97.5} |
| Jan-1972 | 22 | 22 | 22 | — | — | — | — | — | — | — | — | — | — | — | — | — |
| Feb-1972 | 21 | 21 | 21 | — | — | — | — | — | — | — | — | — | — | — | — | — |
| Mar-1972 | 17 | 17 | 17 | — | — | — | — | — | — | — | — | — | — | — | — | — |
| Apr-1972 | 24 | 24 | 24 | — | — | — | — | — | — | — | — | — | — | — | — | — |
| May-1972 | 19 | 19 | 19 | — | — | — | — | — | — | — | — | — | — | — | — | — |
| Jun-1972 | 19 | 19 | 19 | — | — | — | — | — | — | — | — | — | — | — | — | — |
| Jul-1972 | 1 | 0 | 0 | — | 1 | 1 | 1 | 0 | 0 | 0 | 0 | 0 | 1 | — | — | — |
| Jun-1973 | 0 | 0 | 1 | — | 0 | 0 | 0 | 0 | 0 | 0 | 1 | 1 | 1 | — | — | — |
| Jun-1976 | 1 | 2 | 3 | — | 1 | 1 | 1 | 1 | 2 | 2 | 3 | 3 | 4 | — | — | — |
| Apr-1977 | 0 | 1 | 2 | — | 0 | 0 | 1 | 1 | 1 | 2 | 2 | 2 | 3 | — | — | — |

Table S8.6.2. Reconstructed (simulated) Monte Carlo concentrations of trichloroethylene (TCE) in finished water distributed to Holcomb Boulevard family housing areas for selected months, Hadnot Point–Holcomb Boulevard study area, U.S. Marine Corps Base Camp Lejeune, North Carolina, 1972–1985.—Continued^{1,*}

[PP, Paradise Point; MP, Midway Park; BM, Berkeley Manor; WV, Watkins Village; —, not applicable]

| Month-Year | Calibrated TCE concentration ² , in microgram per liter | | | | Range of TCE concentrations derived from Monte Carlo simulations ³ , in micrograms per liter | | | | | | | | | | | |
|-----------------------|---|----|----|-----------------|---|-----------------|-------------------|------------------|-----------------|-------------------|------------------|-----------------|-------------------|------------------------------|-----------------|-------------------|
| | PP | MP | BM | WV ⁴ | Paradise Point | | | Midway Park | | | Berkeley Manor | | | Watkins Village ⁴ | | |
| | | | | | P _{2.5} | P ₅₀ | P _{97.5} | P _{2.5} | P ₅₀ | P _{97.5} | P _{2.5} | P ₅₀ | P _{97.5} | P _{2.5} | P ₅₀ | P _{97.5} |
| May-1977 | 1 | 1 | 3 | — | 0 | 1 | 1 | 1 | 1 | 2 | 2 | 2 | 3 | — | — | — |
| Jun-1977 | 1 | 2 | 3 | — | 0 | 1 | 1 | 1 | 2 | 2 | 2 | 3 | 4 | — | — | — |
| Jul-1977 | 1 | 2 | 3 | — | 0 | 1 | 1 | 1 | 2 | 2 | 3 | 3 | 5 | — | — | — |
| Aug-1977 | 1 | 2 | 4 | — | 1 | 1 | 1 | 1 | 2 | 3 | 3 | 4 | 6 | — | — | — |
| May-1978 | 0 | 2 | 6 | 4 | 0 | 0 | 0 | 2 | 3 | 3 | 5 | 6 | 7 | 3 | 3 | 4 |
| Jun-1978 | 3 | 23 | 51 | 38 | 2 | 4 | 8 | 18 | 23 | 30 | 44 | 49 | 59 | 32 | 38 | 48 |
| Jul-1978 | 0 | 0 | 1 | 1 | 0 | 0 | 0 | 1 | 1 | 2 | 2 | 2 | 3 | 1 | 1 | 2 |
| Apr-1979 | 0 | 1 | 2 | 1 | 0 | 0 | 0 | 1 | 1 | 2 | 2 | 2 | 3 | 1 | 2 | 2 |
| May-1979 | 0 | 1 | 3 | 2 | 0 | 0 | 0 | 1 | 1 | 2 | 2 | 2 | 3 | 1 | 2 | 2 |
| Jun-1979 | 0 | 2 | 6 | 4 | 0 | 0 | 1 | 2 | 2 | 4 | 5 | 6 | 8 | 3 | 4 | 6 |
| Jul-1979 | 0 | 1 | 4 | 2 | 0 | 0 | 0 | 1 | 1 | 2 | 2 | 3 | 4 | 2 | 2 | 3 |
| Aug-1979 | 0 | 2 | 5 | 3 | 0 | 0 | 1 | 1 | 2 | 3 | 3 | 4 | 6 | 2 | 3 | 4 |
| Jun-1980 | 2 | 8 | 17 | 13 | 1 | 2 | 3 | 6 | 8 | 10 | 14 | 16 | 20 | 10 | 12 | 15 |
| Apr-1981 | 0 | 4 | 39 | 28 | 0 | 0 | 2 | 1 | 5 | 9 | 32 | 38 | 46 | 21 | 28 | 35 |
| May-1981 | 0 | 4 | 13 | 10 | 0 | 0 | 1 | 3 | 4 | 6 | 10 | 13 | 16 | 8 | 10 | 13 |
| Jun-1981 | 0 | 4 | 10 | 7 | 0 | 0 | 1 | 1 | 3 | 5 | 8 | 10 | 13 | 5 | 7 | 10 |
| Jul-1981 | 0 | 2 | 4 | 3 | 0 | 0 | 0 | 1 | 2 | 3 | 3 | 4 | 5 | 2 | 3 | 4 |
| Aug-1981 | 0 | 2 | 6 | 4 | 0 | 0 | 1 | 2 | 2 | 4 | 4 | 6 | 7 | 3 | 4 | 5 |
| Apr-1982 | 0 | 3 | 9 | 7 | 0 | 0 | 1 | 3 | 4 | 5 | 7 | 8 | 10 | 5 | 6 | 8 |
| May-1982 | 1 | 6 | 20 | 13 | 0 | 1 | 2 | 2 | 6 | 9 | 17 | 20 | 25 | 11 | 14 | 19 |
| Jun-1982 | 0 | 4 | 10 | 7 | 0 | 0 | 1 | 2 | 4 | 6 | 8 | 10 | 13 | 5 | 7 | 10 |
| Jul-1982 | 0 | 4 | 12 | 8 | 0 | 0 | 2 | 3 | 4 | 7 | 9 | 11 | 14 | 6 | 8 | 11 |
| Aug-1982 | 1 | 3 | 6 | 4 | 0 | 1 | 1 | 2 | 3 | 4 | 5 | 6 | 8 | 3 | 4 | 6 |
| May-1983 | 1 | 5 | 14 | 10 | 0 | 1 | 1 | 2 | 4 | 6 | 14 | 15 | 17 | 10 | 10 | 12 |
| Jun-1983 | 0 | 0 | 2 | 2 | 0 | 0 | 0 | 0 | 0 | 0 | 2 | 2 | 3 | 1 | 2 | 2 |
| Jul-1983 | 0 | 0 | 3 | 2 | 0 | 0 | 0 | 0 | 0 | 1 | 2 | 3 | 4 | 1 | 2 | 3 |
| Aug-1983 | 0 | 2 | 5 | 3 | 0 | 0 | 1 | 1 | 2 | 3 | 4 | 5 | 6 | 3 | 3 | 5 |
| Apr-1984 | 0 | 2 | 5 | 3 | 0 | 0 | 0 | 1 | 2 | 3 | 3 | 4 | 6 | 2 | 3 | 4 |
| Jan-1985 ⁵ | 34 | 31 | 32 | 34 | 33 | 34 | 34 | 31 | 31 | 31 | 31 | 32 | 32 | 34 | 34 | 34 |
| Feb-1985 ⁵ | 66 | 53 | 54 | 56 | 62 | 65 | 70 | 52 | 53 | 55 | 53 | 55 | 57 | 54 | 56 | 59 |

¹Current maximum contaminant level (MCL) for TCE is 5 micrograms per liter (µg/L); See Table A2A for description of TCE MCL value.

²Calibrated concentration is determined from mean monthly concentration.

³Monte Carlo simulated values generated using PEST (Doherty 2004, Doherty and Hunt 2010) consist of 1,000 realizations using normal distribution; P_{2.5}, 2.5 percentile; P₅₀, 50 percentile; P_{97.5}, 97.5 percentile.

⁴Watkins Village housing was not built and occupied until about 1978 (Faye et al. 2010) and the first documented interconnection occurs during May 1978 (Camp Lejeune Water Documents CLW #7023, 7031, and 7033).

⁵For the 8-day period January 28–February 4, 1985, the Holcomb Boulevard water treatment plant was shut down and contaminated Hadnot Point finished water was continuously provided to Holcomb Boulevard family housing areas.

*Prior to June 1972 when Holcomb Boulevard water treatment plant came on line, 100% of Hadnot Point water was delivered to Holcomb Boulevard family housing areas (also see Appendix A6 for January–May 1972).

Table S8.6.3. Reconstructed (simulated) Monte Carlo concentrations of *trans*-1,2-dichloroethylene (1,2-tDCE) in finished water distributed to Holcomb Boulevard family housing areas for selected months, Hadnot Point–Holcomb Boulevard study area, U.S. Marine Corps Base Camp Lejeune, North Carolina, 1972–1985.¹

[PP, Paradise Point; MP, Midway Park; BM, Berkeley Manor; WV, Watkins Village; —, not applicable]

| Month-Year | Calibrated 1,2-tDCE concentration, ² in micrograms per liter | | | | Range of 1,2-tDCE concentrations derived from Monte Carlo simulations, ³ in micrograms per liter | | | | | | | | | | | |
|-----------------------|--|----|----|-----------------|--|-----------------|-------------------|------------------|-----------------|-------------------|------------------|-----------------|-------------------|------------------------------|-----------------|-------------------|
| | PP | MP | BM | WV ⁴ | Paradise Point | | | Midway Park | | | Berkeley Manor | | | Watkins Village ⁴ | | |
| | | | | | P _{2.5} | P ₅₀ | P _{97.5} | P _{2.5} | P ₅₀ | P _{97.5} | P _{2.5} | P ₅₀ | P _{97.5} | P _{2.5} | P ₅₀ | P _{97.5} |
| Jun-1973 | 0 | 1 | 1 | — | 0 | 0 | 0 | 1 | 1 | 1 | 1 | 1 | 2 | — | — | — |
| Jun-1976 | 0 | 1 | 2 | — | 0 | 0 | 0 | 1 | 1 | 1 | 1 | 2 | 2 | — | — | — |
| Apr-1977 | 0 | 1 | 1 | — | 0 | 0 | 0 | 0 | 1 | 1 | 1 | 1 | 1 | — | — | — |
| May-1977 | 0 | 1 | 1 | — | 0 | 0 | 0 | 0 | 1 | 1 | 1 | 1 | 2 | — | — | — |
| Jun-1977 | 0 | 1 | 1 | — | 0 | 0 | 0 | 0 | 1 | 1 | 1 | 1 | 2 | — | — | — |
| Jul-1977 | 0 | 1 | 2 | — | 0 | 0 | 0 | 0 | 1 | 1 | 1 | 2 | 2 | — | — | — |
| Aug-1977 | 0 | 1 | 2 | — | 0 | 0 | 0 | 1 | 1 | 1 | 2 | 2 | 3 | — | — | — |
| May-1978 | 0 | 1 | 3 | 2 | 0 | 0 | 0 | 1 | 1 | 2 | 2 | 3 | 3 | 1 | 2 | 2 |
| Jun-1978 | 2 | 10 | 22 | 17 | 1 | 2 | 4 | 8 | 10 | 13 | 19 | 22 | 26 | 14 | 17 | 21 |
| Jul-1978 | 0 | 0 | 0 | 0 | 0 | 0 | 0 | 0 | 0 | 0 | 0 | 0 | 1 | 0 | 0 | 0 |
| Apr-1979 | 0 | 1 | 1 | 1 | 0 | 0 | 0 | 0 | 1 | 1 | 1 | 1 | 1 | 1 | 1 | 1 |
| May-1979 | 0 | 0 | 1 | 1 | 0 | 0 | 0 | 0 | 0 | 1 | 1 | 1 | 1 | 1 | 1 | 1 |
| Jun-1979 | 0 | 1 | 3 | 2 | 0 | 0 | 0 | 1 | 1 | 2 | 2 | 3 | 3 | 1 | 2 | 2 |
| Jul-1979 | 0 | 0 | 1 | 1 | 0 | 0 | 0 | 0 | 1 | 1 | 1 | 1 | 2 | 1 | 1 | 1 |
| Aug-1979 | 0 | 1 | 2 | 1 | 0 | 0 | 0 | 1 | 1 | 1 | 1 | 2 | 2 | 1 | 1 | 2 |
| Jun-1980 | 1 | 3 | 7 | 5 | 0 | 1 | 1 | 2 | 3 | 4 | 6 | 7 | 8 | 4 | 5 | 6 |
| Apr-1981 | 0 | 2 | 16 | 12 | 0 | 0 | 1 | 0 | 2 | 4 | 13 | 16 | 19 | 9 | 11 | 14 |
| May-1981 | 0 | 2 | 6 | 4 | 0 | 0 | 1 | 1 | 2 | 3 | 4 | 5 | 7 | 3 | 4 | 6 |
| Jun-1981 | 0 | 2 | 4 | 3 | 0 | 0 | 0 | 1 | 1 | 2 | 4 | 4 | 5 | 2 | 3 | 4 |
| Jul-1981 | 0 | 1 | 2 | 1 | 0 | 0 | 0 | 1 | 1 | 1 | 1 | 2 | 2 | 1 | 1 | 2 |
| Aug-1981 | 0 | 1 | 3 | 2 | 0 | 0 | 0 | 1 | 1 | 2 | 2 | 2 | 3 | 1 | 2 | 2 |
| Apr-1982 | 0 | 2 | 4 | 3 | 0 | 0 | 1 | 1 | 2 | 3 | 3 | 4 | 5 | 2 | 3 | 4 |
| May-1982 | 0 | 3 | 10 | 7 | 0 | 0 | 1 | 1 | 3 | 5 | 9 | 10 | 13 | 6 | 7 | 10 |
| Jun-1982 | 0 | 2 | 6 | 4 | 0 | 0 | 1 | 1 | 2 | 3 | 4 | 5 | 7 | 3 | 4 | 5 |
| Jul-1982 | 0 | 2 | 6 | 4 | 0 | 0 | 1 | 2 | 2 | 4 | 5 | 6 | 7 | 3 | 4 | 6 |
| Aug-1982 | 0 | 2 | 3 | 2 | 0 | 0 | 0 | 1 | 2 | 2 | 3 | 3 | 4 | 2 | 2 | 3 |
| May-1983 | 0 | 3 | 8 | 5 | 0 | 0 | 1 | 1 | 2 | 3 | 7 | 8 | 9 | 5 | 6 | 6 |
| Jun-1983 | 0 | 0 | 1 | 1 | 0 | 0 | 0 | 0 | 0 | 0 | 1 | 1 | 1 | 1 | 1 | 1 |
| Jul-1983 | 0 | 0 | 2 | 1 | 0 | 0 | 0 | 0 | 0 | 0 | 1 | 2 | 2 | 1 | 1 | 1 |
| Aug-1983 | 0 | 1 | 3 | 2 | 0 | 0 | 0 | 0 | 1 | 2 | 2 | 3 | 3 | 1 | 2 | 2 |
| Apr-1984 | 0 | 1 | 2 | 2 | 0 | 0 | 0 | 1 | 1 | 1 | 2 | 2 | 3 | 1 | 2 | 2 |
| Jan-1985 ⁵ | 17 | 16 | 16 | 17 | 16 | 17 | 17 | 15 | 16 | 16 | 16 | 16 | 16 | 17 | 17 | 17 |
| Feb-1985 ⁵ | 33 | 27 | 27 | 27 | 31 | 33 | 35 | 26 | 27 | 27 | 27 | 27 | 29 | 27 | 28 | 30 |

¹Current maximum contaminant level (MCL) for 1,2-tDCE is 100 micrograms per liter (µg/L); See Table A2a for description of 1,2-tDCE MCL value.

²Calibrated concentration is determined from mean monthly concentration.

³Monte Carlo simulated values generated using PEST (Doherty 2004, Doherty and Hunt 2010) consist of 1,000 realizations using normal distribution; P_{2.5}, 2.5 percentile; P₅₀, 50 percentile; P_{97.5}, 97.5 percentile.

⁴Watkins Village housing was not built and occupied until about 1978 (Faye et al. 2010) and the first documented interconnection occurs during May 1978 (Camp Lejeune Water Documents CLW #7023, 7031, and 7033).

⁵For the 8-day period January 28–February 4, 1985, the Holcomb Boulevard water treatment plant was shut down and contaminated Hadnot Point finished water was continuously provided to Holcomb Boulevard family housing areas.

Table S8.6.4. Reconstructed (simulated) Monte Carlo concentrations of vinyl chloride (VC) in finished water distributed to Holcomb Boulevard family housing areas for selected months, Hadnot Point–Holcomb Boulevard study area, U.S. Marine Corps Base Camp Lejeune, North Carolina, 1972–1985.¹

[PP, Paradise Point; MP, Midway Park; BM, Berkeley Manor; WV, Watkins Village; —, not applicable]

| Month-Year | Calibrated VC concentration ² , in micrograms per liter | | | | Range of VC concentrations derived from Monte Carlo simulations ³ , in micrograms per liter | | | | | | | | | | | |
|-----------------------|---|----|----|-----------------|--|-----------------|-------------------|------------------|-----------------|-------------------|------------------|-----------------|-------------------|------------------------------|-----------------|-------------------|
| | PP | MP | BM | WV ⁴ | Paradise Point | | | Midway Park | | | Berkeley Manor | | | Watkins Village ⁴ | | |
| | | | | | P _{2.5} | P ₅₀ | P _{97.5} | P _{2.5} | P ₅₀ | P _{97.5} | P _{2.5} | P ₅₀ | P _{97.5} | P _{2.5} | P ₅₀ | P _{97.5} |
| Jun-1978 | 0 | 1 | 3 | 2 | 0 | 0 | 0 | 1 | 1 | 2 | 2 | 3 | 3 | 2 | 2 | 3 |
| Jun-1980 | 0 | 1 | 1 | 1 | 0 | 0 | 0 | 0 | 1 | 1 | 1 | 1 | 1 | 1 | 1 | 1 |
| Apr-1981 | 0 | 0 | 3 | 2 | 0 | 0 | 0 | 0 | 0 | 1 | 2 | 2 | 3 | 1 | 2 | 2 |
| May-1981 | 0 | 0 | 1 | 1 | 0 | 0 | 0 | 0 | 0 | 0 | 1 | 1 | 1 | 1 | 1 | 1 |
| Jun-1981 | 0 | 0 | 1 | 0 | 0 | 0 | 0 | 0 | 0 | 0 | 1 | 1 | 1 | 0 | 0 | 1 |
| Apr-1982 | 0 | 0 | 1 | 0 | 0 | 0 | 0 | 0 | 0 | 0 | 0 | 1 | 1 | 0 | 0 | 1 |
| May-1982 | 0 | 0 | 1 | 1 | 0 | 0 | 0 | 0 | 0 | 1 | 1 | 1 | 2 | 1 | 1 | 1 |
| Jun-1982 | 0 | 0 | 1 | 1 | 0 | 0 | 0 | 0 | 0 | 0 | 1 | 1 | 1 | 0 | 1 | 1 |
| Jul-1982 | 0 | 0 | 1 | 1 | 0 | 0 | 0 | 0 | 0 | 1 | 1 | 1 | 1 | 0 | 1 | 1 |
| May-1983 | 0 | 0 | 1 | 1 | 0 | 0 | 0 | 0 | 0 | 0 | 1 | 1 | 1 | 1 | 1 | 1 |
| Aug-1983 | 0 | 0 | 0 | 0 | 0 | 0 | 0 | 0 | 0 | 0 | 0 | 0 | 1 | 0 | 0 | 0 |
| Jan-1985 ⁵ | 3 | 3 | 3 | 3 | 3 | 3 | 3 | 3 | 3 | 3 | 3 | 3 | 3 | 3 | 3 | 3 |
| Feb-1985 ⁵ | 6 | 5 | 5 | 5 | 6 | 6 | 7 | 5 | 5 | 5 | 5 | 5 | 5 | 5 | 5 | 6 |

¹Current maximum contaminant level (MCL) for VC is 2 micrograms per liter ($\mu\text{g/L}$); See Table A2a for description of VC MCL value.

²Calibrated concentration is determined from mean monthly concentration.

³Monte Carlo simulated values generated using PEST (Doherty 2004, Doherty and Hunt 2010) consist of 1,000 realizations using normal distribution; P_{2.5}, 2.5 percentile; P₅₀, 50 percentile; P_{97.5}, 97.5 percentile.

⁴Watkins Village housing was not built and occupied until about 1978 (Faye et al. 2010) and the first documented interconnection occurs during May 1978 (Camp Lejeune Water Documents CLW #7023, 7031, and 7033).

⁵For the 8-day period January 28–February 4, 1985, the Holcomb Boulevard water treatment plant was shut down and contaminated Hadnot Point finished water was continuously provided to Holcomb Boulevard family housing areas.

Table S8.6.5. Reconstructed (simulated) Monte Carlo concentrations of benzene in finished water distributed to Holcomb Boulevard family housing areas for selected months, Hadnot Point–Holcomb Boulevard study area, U.S. Marine Corps Base Camp Lejeune, North Carolina, 1972–1985.^{1,*}

[PP, Paradise Point; MP, Midway Park; BM, Berkeley Manor; WV, Watkins Village; —, not applicable]

| Month-Year | Calibrated benzene concentration, ² in micrograms per liter | | | | Range of benzene concentrations derived from Monte Carlo simulations, ³ in micrograms per liter | | | | | | | | | | | |
|-----------------------|---|----|----|-----------------|---|-----------------|-------------------|------------------|-----------------|-------------------|------------------|-----------------|-------------------|------------------------------|-----------------|-------------------|
| | | | | | Paradise Point | | | Midway Park | | | Berkeley Manor | | | Watkins Village ⁴ | | |
| | PP | MP | BM | WV ⁴ | P _{2.5} | P ₅₀ | P _{97.5} | P _{2.5} | P ₅₀ | P _{97.5} | P _{2.5} | P ₅₀ | P _{97.5} | P _{2.5} | P ₅₀ | P _{97.5} |
| Jan-1972 | 3 | 3 | 3 | — | — | — | — | — | — | — | — | — | — | — | — | — |
| Feb-1972 | 3 | 3 | 3 | — | — | — | — | — | — | — | — | — | — | — | — | — |
| Mar-1972 | 2 | 2 | 2 | — | — | — | — | — | — | — | — | — | — | — | — | — |
| Apr-1972 | 3 | 3 | 3 | — | — | — | — | — | — | — | — | — | — | — | — | — |
| May-1972 | 3 | 3 | 3 | — | — | — | — | — | — | — | — | — | — | — | — | — |
| Jun-1972 | 3 | 3 | 3 | — | — | — | — | — | — | — | — | — | — | — | — | — |
| Jun-1978 | 0 | 0 | 1 | 0 | 0 | 0 | 0 | 0 | 0 | 0 | 0 | 0 | 1 | 0 | 0 | 0 |
| Apr-1981 | 0 | 0 | 1 | 1 | 0 | 0 | 0 | 0 | 0 | 0 | 1 | 1 | 2 | 1 | 1 | 1 |
| Feb-1985 ⁵ | 1 | 1 | 1 | 1 | 1 | 1 | 1 | 1 | 1 | 1 | 1 | 1 | 1 | 1 | 1 | 1 |

¹Current maximum contaminant level (MCL) for benzene is 5 micrograms per liter (µg/L); See Table A2a for description of benzene MCL value.²Calibrated concentration is determined from mean monthly concentration.³Monte Carlo simulated values generated using PEST (Doherty 2004, Doherty and Hunt 2010) consist of 1,000 realizations using normal distribution; P_{2.5}, 2.5 percentile; P₅₀, 50 percentile; P_{97.5}, 97.5 percentile.⁴Watkins Village housing was not built and occupied until about 1978 (Faye et al. 2010) and the first documented interconnection occurs during May 1978 (Camp Lejeune Water Documents CLW #7023, 7031, and 7033).⁵For the 8-day period January 28–February 4, 1985, the Holcomb Boulevard water treatment plant was shut down and contaminated Hadnot Point finished water was continuously provided to Holcomb Boulevard family housing areas.

*Prior to June 1972 when Holcomb Boulevard water treatment plant came on line, 100% of Hadnot Point water was delivered to Holcomb Boulevard family housing areas (also see Appendix A6 for January–May 1972).

Analyses and Historical Reconstruction of Groundwater Flow, Contaminant Fate and Transport, and Distribution of Drinking Water Within the Service Areas of the Hadnot Point and Holcomb Boulevard Water Treatment Plants and Vicinities, U.S. Marine Corps Base Camp Lejeune, North Carolina—Chapter A—Supplement 8: Field Tests, Data Analyses, and Simulation of the Distribution of Drinking Water with Emphasis on Intermittent Transfers of Drinking Water Between the Hadnot Point and Holcomb Boulevard Water-Distribution Systems